

CASTLE ROCK STATE PARK

GENERAL PLAN and Environmental Impact Report



Approved by the
State Park and Recreation Commission on
March 2000

Castle Rock State Park General Plan / EIR

This document represents the Final General Plan and Environmental Impact Report approved by the State Park and Recreation Commission on March 8, 2000, which includes the text revisions reflected in Addendum #2, dated March 1, 2000.

Included at the end of this document (Appendix H) is a copy of the General Plan Amendment and Supplement EIR for Walk-in Campsites at Partridge Farm approved by the Commission on October 25, 2000.

Also included is a copy of a Settlement Agreement (Appendix I) executed in July 2003 that further guides appropriate site planning and development.

© 2013 California State Parks
All photographs copyright California State Parks unless otherwise noted.

This document is also available as an electronic file at
www.parks.ca.gov/planning

DEPARTMENT OF PARKS AND RECREATION

STATE PARK AND RECREATION COMMISSION

P.O. BOX 942896, SACRAMENTO, CA 94296-0001



Resolution 5-00
adopted by the
CALIFORNIA STATE PARK AND RECREATION COMMISSION
at its regular meeting in San Jose on
March 8, 2000

WHEREAS, the Director of the Department of Parks and Recreation has presented to this Commission for approval the proposed General Plan for Castle Rock State Park; and

WHEREAS, this document reflects long-range development plans to provide for optimum use and enjoyment of the unit as well as the protection of its quality, resources and diversity; and

WHEREAS, it is the Commission's view that added walk-in camping is desirable at Castle Rock State Park, therefore the Commission directs the staff to re-evaluate the issue of camping in this Plan and, if appropriate, to prepare an amendment to the Plan addressing this subject at a Commission meeting no later than six months from today;

NOW, THEREFORE, BE IT RESOLVED that the California State Park and Recreation Commission hereby approves the Department of Parks and Recreation's Castle Rock State Park Preliminary General Plan, dated February 1999, subject to such environmental changes as the Director of Parks and Recreation shall determine advisable and necessary to implement the provisions of said plan.

STATE PARK AND RECREATION COMMISSION

P.O. BOX 942896, SACRAMENTO, CA 94296-0001



Resolution 6-00
adopted by the
CALIFORNIA STATE PARK AND RECREATION COMMISSION
at its regular meeting in San Jose on
March 8, 2000

WHEREAS, the Director of the Department of Parks and Recreation has proposed an 1800-acre Natural Preserve be established in the core ecological area of Castle Rock State Park to provide for the recognition and protection of significant natural resources at the headwaters of the San Lorenzo River; and

WHEREAS, the proposed Natural Preserve contains highly significant natural, geologic and esthetic resources, including rare tafoni sandstone formations and a diversity of plant communities and wildlife habitats; and

WHEREAS, encompassed within the proposed boundaries of the Natural Preserve are plant communities of local or statewide significance, including the black oak woodland, redwood forest, white alder forest and knobcone pine forest, which provides habitat for listed wildlife species, including potential marbled murrelet and peregrine falcon nesting, and spawning steelhead trout; and

NOW, THEREFORE, BE IT RESOLVED pursuant to Section 5019.50 of the Public Resources Code, and after proceedings in accordance with the Administrative Procedures Act, that the California State Park and Recreation Commission hereby classifies approximately 1800 acres in Castle Rock State Park as a Natural Preserve and names the unit San Lorenzo Headwaters Natural Preserve.

CASTLE ROCK STATE PARK

GENERAL PLAN
and
Environmental Impact Report

State Clearinghouse #1997122063

Approved by the State Park and Recreation Commission
March 2000



GRAY DAVIS
Governor

KENNETH B. JONES
Chief Deputy Director
Department of Parks and Recreation
P.O. Box 942896
Sacramento, CA 94296-0001

MARY D. NICHOLS
Secretary for Resources

Blank page

TABLE OF CONTENTS

INTRODUCTION

- 1 PARK LOCATION AND SETTING
- 1 THE PARK'S INCEPTION
- 2 SPIRIT OF PLACE
- 3 PURPOSE OF THIS GENERAL PLAN

EXISTING CONDITIONS

- 7 EXISTING LAND USE
 - 7 Regional Land Use
- 11 SIGNIFICANT RESOURCE VALUES
 - 11 Natural Resources
 - 11 Plant Life
 - 15 Animal Life
 - 18 Aquatic Life
 - 19 Ecology
 - 19 Physical Resources
 - 24 Cultural Resources
 - 24 Prehistoric Resources
 - 25 Native American Ethnographic Overview
 - 27 Historic Resources
- 33 EXISTING FACILITIES
 - 33 Existing Trails
 - 33 Existing Parking Facilities
 - 34 Existing Camping Facilities
 - 35 Existing Operations & Facilities
- 39 PLANNING INFLUENCES
 - 39 System-wide Planning
 - 40 Unit Classification
 - 41 Subclassification
 - 41 Zone Of Primary Interest
 - 42 The Planning Process & Public Participation
- 44 DISCUSSION OF LAND USE ISSUES
 - 44 Public Access, Development, and Use of Partridge Farm Area
 - 45 Rock Climbing and the Protection of Significant Resources
 - 47 Statewide Camping Interest and the Lack of Overnight Accommodations

THE PLAN

51	UNIT PURPOSE AND VISION
51	Resource Values
53	Declaration of Purpose
53	Unit Vision
55	GENERAL UNIT MANAGEMENT GOALS & GUIDELINES
55	Resource Management Zones
59	Unitwide Resource Management Goals and Guidelines
59	Natural Resources
67	Cultural Resources
68	Esthetic Resources
69	UNITWIDE VISITOR USE & OPPORTUNITIES
69	Carrying Capacity
70	Allowable Use Intensity
72	Managing Resources and Visitor Impacts
74	Unitwide Access and Trails
75	Unitwide Interpretation
81	Unitwide Concessions
82	AREA GOALS & GUIDELINES
82	Natural Preserve Area
85	Travertine Springs Area
86	Partridge Farm Area
92	Guidelines For Multiple Areas
92	Rock Climbing
94	Parking and Access
98	Historic Features
100	Saratoga Gap
100	Park Administration
101	Multi-agency Visitor Center Concept

ENVIRONMENTAL ANALYSIS

104	Summary
105	Project Description
106	Description of Environmental Setting
107	Air Quality
108	Esthetics
109	Traffic and Parking
110	Significant Environmental Effects of The Proposed Project
112	Mitigation Measures
114	Environmental Effects That Cannot Be Avoided if the Project is Implemented
114	Alternatives to the Proposed Project
115	Preservation Priority Alternative

117	Recreation Priority Alternative
119	Wilderness Classification Alternative
120	No Project Alternative
121	Significant Irreversible Environmental Changes if the Project is Implemented
121	Growth Inducing Impact of the Proposed Project
121	Effects Found Not to be Significant
123	References

APPENDICES

126	Appendix A	Partial Plant Species List
128	Appendix B	Special Animals List
134	Appendix C	Wildlife Habitat - Plant Community Relationship
136	Appendix D	Selected Systemwide Resource Management Directives
140	Appendix E	1998 Trails Inventory and Existing Roadside Parking
142	Appendix F	Non-Motorized Bike Use (Policy IV.2)
144	Appendix G	Rock Climbing Policy
146	Appendix H	Castle Rock GP Amendment and Supplement EIR for Walk-in Campsites at Partridge Farm - October 2000
171	Appendix I	Settlement Agreement – July 2003

LIST OF TABLES

57	Table 1	Resource Management Zones
133	Table 2	Wildlife Habitat - Plant Community Relationship
139	Table 3	1998 Trails Inventory
141	Table 4	Existing Roadside Parking

LIST OF FIGURES

1	Figure 1	Santa Cruz Mountains Vicinity Map
73	Figure 2	Allowable Use Intensity Map
107	Figure 3	Traffic Volumes
108	Figure 4	Saratoga Gap Intersection Flow

LIST OF MAPS

MAP No. 1	Plant Communities
MAP No. 2	Wildlife Habitat Types and Sensitive Animal Species
MAP No. 3	Ecological Units
MAP No. 4	Cultural Resources
MAP No. 5	Resource Management Zones
MAP No. 6	Proposed Natural Preserve
MAP No. 7	Existing Conditions
MAP No. 8	Land Use and Facility Guidelines

Blank page

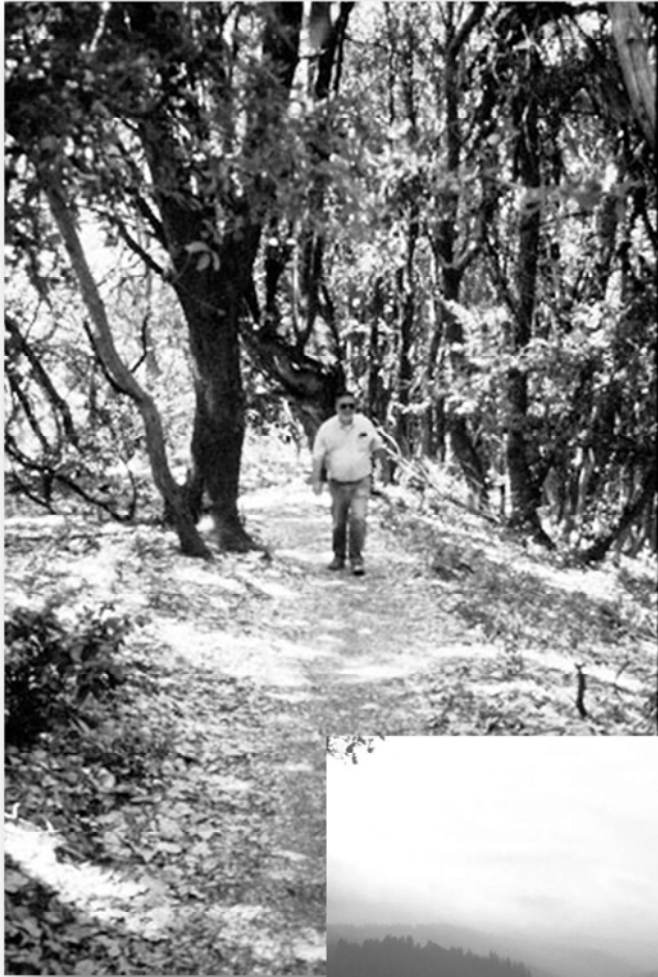

INTRODUCTION

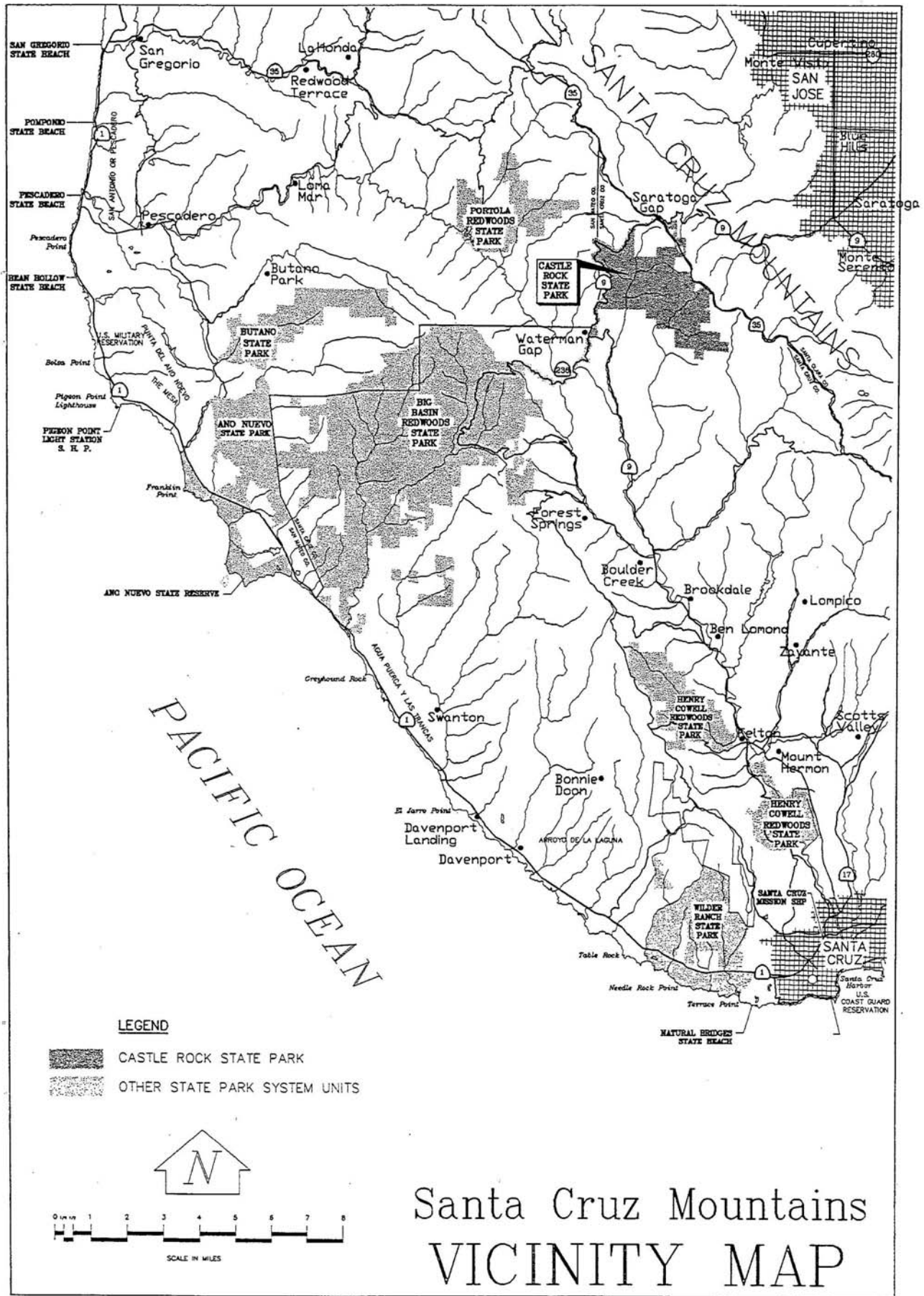

Santa Cruz Mountains VICINITY MAP

INTRODUCTION

PARK LOCATION AND SETTING

Castle Rock State Park occupies a part of the Santa Cruz Mountains and encompasses 3,860 acres at the headwaters of the San Lorenzo River. The park is situated in Santa Cruz, Santa Clara, and San Mateo Counties. It is within one hour's drive from San Jose and the Santa Clara Valley and only a slightly longer drive from San Francisco. Thus, it makes an ideal spot for a getaway day or weekend for some of the millions of people living in the Bay Area. Above the smog and fog, visitors can picnic in rolling meadows, hike or ride horses through chaparral and mixed evergreen forest, enjoy spectacular vistas, and see an array of wildflowers, wildlife, and unusual sandstone caves and rock formations. Limited day use and primitive camping facilities have been developed. Along the 33 miles of park trails are campsites for backpackers and access to large rock formations that are popular with rock climbers.

Castle Rock State Park is interconnected with a larger regional system of parks and open space preserves. The park is adjacent to Santa Clara County's Sanborn-Skyline Park and the Midpeninsula Regional Open Space District's Preserve at Saratoga Gap. The closest State Park System units are Big Basin Redwoods State Park, 8 miles to the southwest, and Portola Redwoods State Park, 12 miles to the northwest. State Highways 9 and 35 (Skyline Blvd.) are the principal transportation corridors serving the park. These transportation routes connect the coastal Santa Cruz area with various communities of the San Lorenzo Valley and the San Jose urban area. Two major regional trail corridors, the Skyline-to-the-Sea and the Bay Area Ridge Trail (including Skyline Trail), provide valuable recreational linkages between Castle Rock State Park and the San Francisco Bay area and Santa Cruz coast.

THE PARK'S INCEPTION

The setting aside of land for the benefit of all requires people of vision with a sense of values greater than their own personal needs. Judge Joseph Welch and Russell Varian were such people. When Judge Welch of San Jose purchased a 60-acre parcel on Castle Rock Ridge in 1908, logging was still shattering the stillness downslope. Welch, however, established a precedent by making "Castle Rock" and a few acres around the rock available for those people who wanted to enjoy the beauty of the area. Russell Varian had frequently hiked the rugged Castle Rock area as a boy and young man in the earlier part of this century. Varian imagined the land around Castle Rock becoming a public park, a place for people to enjoy as he had. He sought the help of organizations with like-minded interests, and in 1959, with the help of the Sierra Club, obtained an option to buy 27 acres of the land around Castle Rock. When the park was

officially opened as Castle Rock State Park on July 12, 1968, it had reached 513 acres. With the help of the Sempervirens Fund and other organizations, it has continued to grow to the present 3,860 acres.

Russell Varian's Wilderness Legacy

*"To enter the wilderness world, one must go unencumbered
by the values of the world which he has fled,
and find anew the values that are ages old"*

Russell Varian

SPIRIT OF PLACE

Castle Rock State Park lands are a diverse mix of natural features that include most of the remnant ecosystem types of the Santa Cruz Mountains. Although substantially altered since the arrival of Euro-Americans, the recovering park lands provide a glimpse of the original primeval character of the Santa Cruz Mountains. One can gaze from the ridgetops along Highway 9 and Skyline Boulevard or hike over a landscape of steep, densely vegetated canyons, dense redwood and mixed evergreen forests, oak woodlands, and open grasslands. Many of the ridges are embellished with sandstone rock outcrops that include very rare tafoni formations. On clear days the outstanding scenic views extend south to Monterey Bay and beyond. To the west nearly the entire length of forested Ben Lomond Mountain is discernible. A portion of Big Basin Redwoods State Park is visible in the near distance. To the north grassland covered ridges and steep, forested canyons extend to the horizon. The ecological linkage between Castle Rock State Park and other natural areas of the Santa Cruz Mountains is apparent. Little evidence of human occupation is visible from the park.

Along park trails one can view cascading streams and luxuriant vegetation. In the spring wildflowers are abundant in the grasslands and oak savannahs of the park. Near Partridge Farm are numerous large, old live and black oak trees. A short distance away are large rock outcrops where experienced climbers can enjoy a view of the San Lorenzo Valley and Monterey Bay. Not as readily seen, the fortunate visitor may encounter some of the larger mammals of the park, such as deer and bobcat. On warm days it is not uncommon to see turkey vultures cruising overhead on thermals in search of food.

In a few locations are remnants of past occupation; Indian bedrock mortars, old cabin sites, a farm house, and orchards. The recovering vegetation has since altered the historic settings, and in many instances one must visualize how these historic cultural features contribute to the sense of place.

On clear, moonless nights at Castle Rock celestial bodies adorn the sky owing to the lack of light pollution sources so common in the metropolitan areas of the Santa Clara Valley to the east. For those who have the opportunity, the peacefulness of such an experience contrasts sharply with the urban environment below. The overall impression of the park for many visitors is a place of peace, tranquillity, beauty, and experience far removed from the pressures of the modern world.



San Lorenzo River Watershed looking west toward the Pacific Ocean

PURPOSE OF THIS GENERAL PLAN

The general plan is the primary management document for a unit of the State Park System, establishing its purpose and a management direction for the future. By providing a defined purpose and vision with long-term goals and guidelines, it provides the framework for a unit's development, ongoing management, and public use. Thereafter, this framework assists in guiding daily decision-making and serves as the basis for developing more detailed management and site-specific project plans.

This document was prepared by the California Department of Parks and Recreation to satisfy the requirements of the California Public Resources Code (PRC) Section 5002.2. The PRC specifies that a general plan will be prepared prior to development of any new facilities and shall consist of elements of discussion that will evaluate and define the proposed management of resources, land uses, facilities, concessions, operation of the

unit, and any environmental impacts. The Castle Rock State Park General Plan must be submitted to the State Park and Recreation Commission for approval.

This general plan identifies and analyzes the relative importance of the park's various resources, provides guidelines for their preservation and management, and makes proposals for their appreciation through interpretation. It proposes improvements to attain expected compatible land uses, and describes the nature and general location of future developments. It outlines future operational needs and also provides an assessment of the potential cumulative environmental impacts as a result of the plan's implementation.

In early 1994 the Department identified the need to prepare a general plan for Castle Rock State Park. This state park has long been recognized as an integral part of the Santa Cruz Mountains ecological system and for its recreational value to a major population area. Several issues prevail at this time regarding watershed management and resource impacts occurring from current and past activities. Cultural areas were known to exist in the unit; however, their significance was unknown in many cases. Some of the old roadways now serve as trails and are the primary facilities that exist for the public's use. Random off-trail use is causing soil erosion, with loss of vegetation and degradation of wildlife habitat. Therefore, existing activities and potential use areas needed to be evaluated relative to resource significance, and guidelines developed for appropriate management and use.



EXISTING CONDITIONS

Blank side of divider page

EXISTING CONDITIONS

EXISTING LAND USE

The nearly 4,000 acres of Castle Rock State Park is mostly steep terrain and forested canyons. The existing trail system provides access from multiple parking locations and trailheads into this wildlands area. The most popular activities include hiking, rock climbing, and nature walks; to a lesser degree, camping and horseback riding. The unusual sandstone caves and large rock formations offer excellent opportunities for rock climbing. Popular climbing areas include Goat Rock, Castle Rock, Castle Rock Falls, and the Underworld, to name a few. The locations of existing park facilities are at the Castle Rock Campground, Partridge Farm, Tin Can Ranch, Sempervirens Point, and Waterman Gap (See Existing Conditions Map No. 7).

Annual attendance at Castle Rock State Park is recorded above 70,000 visitors per year. The monthly attendance ranges from 4,500 people in the winter to 7,000 people in the Spring and Fall. Review of the trail system during a peak month demonstrated a typical visitor attendance of 250 to 300 people on park trails at any one time, or peak attendance around 1,400 visitors per day.

Castle Rock State Park is also interconnected within a larger system of regional trails and open space recreation areas. State park trails connect to regional trails in the Sanborn-Skyline County Park, Saratoga Gap Open Space Preserve, San Lorenzo Valley Water District and Big Basin Redwoods State Park, where they extend to the Pacific Ocean and to the San Francisco Bay. These parks offer a wide range of recreational opportunities and facilities, including playgrounds, campgrounds, picnic areas, and miles of trails designated for hiking, horseback riding, or multiple use which includes bicycles.

REGIONAL LAND USE

Consideration of regional context is important to any discussion of the land use and facilities at Castle Rock State Park. The unit is located at the heart of the Santa Cruz Mountains surrounded by a network of state, county and regional parks, and open space preserves. This region offers a wide range of recreational opportunities; it also preserves a significant amount of public open space and wildland habitat. Castle Rock State Park must be viewed, not only for the features and values it possesses within its boundaries, but in its relationship within this network of greenbelts and regional recreation corridors of the greater Santa Cruz Mountains.

In this context, the park has become a destination for people that seek a more primitive recreational experience and an opportunity to explore its diverse landscape. Its character and land uses are generally compatible with its regional surroundings. A wide range of facilities and diverse recreational opportunities provided in other parks complements those presently available at Castle Rock. Planners must recognize the importance of regional diversity, both in managing for natural processes and providing for quality recreational opportunities.

The following describes the current public land management agencies and land uses surrounding Castle Rock State Park.

Midpeninsula Regional Open Space District

The Midpeninsula Regional Open Space District (MROSD) offers over 250 miles of hiking trails, ranging from easy walks to challenging excursions in 23 open space preserves totaling over 43,000 acres. Bicycles and horses are permitted on many District trails. The open space preserves are developed with only the amenities needed to provide public access for low-intensity recreation. Improvements may include gravel parking areas, restrooms, signed trails, and occasional picnic tables.

The District's mission and purpose is: *"To acquire and permanently preserve a regional open space greenbelt, protecting and restoring the wilderness, wildlife habitat, watershed, viewshed, and fragile ecosystems. Linking District lands with other public park lands will eventually form a continuous greenbelt of permanently protected open space that will be enjoyed by generations to come."*

The Saratoga Gap and Long Ridge Open Space Preserves managed by MROSD are located north of Castle Rock State Park along Skyline Boulevard. Combined, they include over 2,200 acres and 16 miles of hiking, mountain bicycling, and equestrian trails. Hiking trails connect with Castle Rock State Park via the Skyline Trail (also part of the Bay Area Ridge Trail) and the Skyline-to-the-Sea Trail.

Santa Clara County Parks

Sanborn-Skyline County Park is contiguous to Castle Rock State Park along the state park's eastern boundary. Primarily redwood and mixed evergreen forest, Sanborn has many miles of hiking trails, group picnic sites, walk-in campsites, and a small RV campground. Unique to this location are the Youth Science Institute and the American Youth Hostel. Upper Stevens Creek County Park is located one mile north of Saratoga Gap and offers a wilderness experience for visitors interested in the park's mature stands of Douglas-fir and redwood. The park is also popular with hikers for its long trails and valley vistas, and for bicyclists on mountain roads.

Visitors make little distinction between the state and other parks along Skyline Boulevard. Hiking and equestrian trails cross the highway, providing access and

connecting the state, county, and regional parks together for a variety of recreational uses. Visitors also share the roadside parking areas along Highway 35 for trail use and access to popular rock climbing areas at Castle Rock State Park and Sanborn-Skyline County Park.

State of California Department of Transportation - Saratoga Gap Maintenance Facility

Located on the southwest corner at the intersection of Highway 35 and Highway 9 is a 1.3 acre parcel owned by Caltrans. This location is the site of a former Caltrans maintenance yard that served for highway maintenance in the Saratoga Gap vicinity until 1997. The facility includes an old residence and a large vehicle storage and maintenance shed. This site is accessed from Highway 35 and by an entrance road shared with residents of the Indian Rock Ranch subdivision.

Caltrans has indicated their desire to surplus this property, which could make it available for consideration and potential use by State Parks.

San Lorenzo Valley Water District - Waterman Gap Unit

The San Lorenzo Valley Water District owns 1,370 acres (Waterman Gap Unit) abutting the southern boundary of Castle Rock State Park. The State Park and adjoining Waterman Gap Unit are at the headwaters of the San Lorenzo River and, as such, share interests and watershed management responsibilities. The Water District property includes terrain and resource values similar to the state park.

Public access onto Water District property is limited to recreation easements granted to State Parks for use of the Toll Road across Water District property and the trail camp at Waterman Gap. The Kings Creek Truck Trail, an unpaved private road, goes from Highway 35 at Mount Bielawski to the Saratoga Toll Road, and a short distance beyond to State Highway 9. This route travels through the state park, private lands, and water district properties, and provides access for water district management, emergency vehicles, and park ranger patrols. This road is not open for public use.

Our Department shares an interest with the San Lorenzo Valley Water District in watershed management policies and protection of significant natural and cultural resources. Land use agreements and easements for recreation or preservation are encouraged between these two agencies in order to provide for public access, recreation, and appropriate watershed management. Also, the Department has expressed an interest in water district property as a potential addition to the state park if offered for sale.

Residential Developments

Overlooking Castle Rock State Park is the Indian Rock Ranch subdivision. This low-density residential community consists of approximately 535 acres and 32 single family residences situated on the hillside near Saratoga Gap, of which a few are visible from the park. The main access into this subdivision is from Indian Rock Ranch Road off Highway 35. The Department acquired a 60-foot wide recreation trail easement on this road from the Skyline-to-the-Sea Trail to the Saratoga Gap trail. This trail route is authorized for hikers and equestrians.

Additional single-family residences are located near the park along both highways, including the Las Cumbres subdivision to the south off Highway 35. Concerns expressed in the past by neighboring residents have been indiscriminate parking, highway traffic and pedestrian safety, public trespass onto private property, inadequate ranger staffing, park land acquisition, and wildfire protection.

Commercial Developments

The Los Altos Gun Club is a privately owned and operated shooting facility located adjacent to the park along Highway 35, one mile north of the main parking lot. The driveway entrance into the gun club from Highway 35 is shared with the state park service road and trail. This facility existed before the establishment of the state park. Results of a visitor survey administered by the Department indicate that most visitors would prefer that the gun club be reestablished elsewhere because of the noise impact on their recreational experience. However, the Department does not have jurisdiction or authority over the gun club operations, and therefore, it does not propose specific actions in this general plan. As a close neighbor, the Department is concerned for visitor safety and the impact the shooting range has on the visitor's experience and surrounding resource values. The Department's cooperative relationship with the gun club will aim to minimize potential impacts for as long as it operates next to the park.

Located on private property directly south of Partridge Farm and north of the Castle Rock parking lot is a commercial Christmas tree farm and year around residence. This triangular piece of property is surrounded by park property on two sides and Highway 35 on the east. Mutual concerns include maintaining boundary fencing and trespass. If this property near the main park entrance is ever offered for sale by a willing seller, the Department should consider its benefits for possible future acquisition.

SIGNIFICANT RESOURCE VALUES

The following resource information is a summary and evaluation of data contained in the Resources Inventory for Castle Rock State Park. More detailed information contained in this inventory will be on file with the Department in the district headquarters. The natural resources information is presented by category of biotic and abiotic conditions, followed by cultural resource information.

NATURAL RESOURCES

PLANT LIFE

Castle Rock State Park lies within the Central Coast Region of the California Floristic Province. This floristic province encompasses most of California and a small portion of Nevada, Baja California, and Oregon. The Central Coast Region has a rich endemic flora because of the great variety of habitats and relative stability of the climate.

Only common plant names are used in the Plant Life Section. The corresponding scientific names appear on the Plant Species List in Appendix A.

Special Plants

Special plants are listed annually on the California Department of Fish and Game's (CDFG) Special Plant List. A subset of the Special Plant List includes those species listed by the U.S. Fish and Wildlife Service, the CDFG, and the California Native Plant Society (CNPS) as rare, threatened, or endangered. The only special plant species identified to date at Castle Rock State Park is Brewer's calandrinia, which is a CNPS List 4 plant. It occurs in the Castle Rock Ridge portion of the park. Due to the diversity and size of the unit, it is possible that other special plant species could be discovered. Suitable habitat exists for 14 additional special plant species that are known to occur in the vicinity of the park.

Plants of Special Interest

Plants of special interest are species of scientific, educational, or interpretive value. These include plants that are uncommon, at the limit of their native range, of unusual size, form, color or beauty, or have important and unusual relationships with animal life. Several plant species in Castle Rock State Park fit one or more of these criteria. A very large, impressive specimen of the hybrid, oracle oak, is growing within a half mile of the

Partridge Farm interpretive shelter. This tree is partly deciduous and partly evergreen. Park species that reach their southern limits of Coast Range distribution in the Santa Cruz Mountains include Oregon ash, California hazelnut, and California nutmeg. Species occurring in the park that reach their northern limits of Coast Range distribution in the Santa Cruz Mountains include black sage, warty-leaved ceanothus, and stinging lupine.

Exotic Species

Exotic plant species are of concern at numerous locations in Castle Rock State Park. Infestations are usually not extensive at any one location, but tend to be widespread in the park. Locations with the most serious problems are those that have experienced the greatest disturbance from past or current human activities. Exotic species of most concern are French broom, periwinkle, yellow star-thistle, Italian thistle, and non-indigenous ponderosa and Coulter pine.

Plant Communities

Plant community classifications and descriptions that follow are partly derived from a 1986 publication by Bob Holland of the Department of Fish and Game. Nine plant communities are recognized at Castle Rock State Park (See Plant Communities Map No. 1). The communities are:

- Mixed Evergreen Forest
- Black Oak Woodland
- Interior Live Oak Woodland
- Knobcone Pine Forest
- Upland Redwood Forest
- White Alder Riparian Forest
- Northern Mixed Chaparral
- Bald Hills Prairie
- Non-native Grassland

Knobcone Pine Forest and White Alder Riparian Forest are designated as Rare Natural Communities by the California Department of Fish and Game's Natural Diversity Data Base. Black Oak Woodland stands in the park are considered locally significant because they are the best examples of a community that is rare in the Santa Cruz Mountains. Ancient redwood stands in the park are critical habitat for the federally listed threatened (state-listed endangered) marbled murrelet.

Knobcone Pine Forest

This community is limited to four sites totaling about 30 acres in the vicinity of the Castle Rock campground. It intergrades with and is surrounded by Northern Mixed Chaparral.

A sparse understory of poison oak, manzanita, and chamise is overtopped by a knobcone pine dominated canopy. A substantial ground layer of leaf litter and woody debris reflects an absence of recent fires. Stands of Knobcone Pine Forest are usually limited to poor soils and are typically even-aged, as a result of a previous fire event. Fire is usually necessary to open the cones of knobcone pine and to create pioneer conditions necessary for seedling establishment. Continued fire exclusion from knobcone pine stands in Castle Rock State Park will eventually result in the disappearance of this rare community.

White Alder Riparian Forest

This community is limited to a narrow strip along perennial streamcourses, primarily Kings Creek and the San Lorenzo River. It intergrades with Upland Redwood Forest in moister locations and Mixed Evergreen Forest in drier situations. White alder and big leaf maple dominate the canopy, with lesser numbers of willow forming a subcanopy. In some locations willows are the dominant trees in the canopy. Common understory species include five-finger fern, coastal wood fern, small-leaved montia, scarlet monkey flower, and skunkweed.

Black Oak Woodland

Black Oak Woodland is restricted to the uppermost slopes and ridgetops of the park. The most extensive occurrence in the Santa Cruz Mountains is located in the Goat Rock area. California black oak dominates this community; interior live oak and canyon live oak are secondary dominants in the canopy. Understory species include poison oak, non-native dogtail grass, blue wildrye, California buttercup, baby blue eyes, and wooly Indian paintbrush.

In general, stands of California black oak are even-aged, originating from some past disturbance such as fire or logging. In the absence of disturbance, black oaks can be overtopped by conifers and eventually replaced because of inherent shade intolerance. Much of the Black Oak Woodland in Castle Rock State Park is at risk of being replaced by Mixed Evergreen Forest because of fire exclusion. Restoration of fire as a natural process in this community would reverse this trend and maintain a viable Black Oak Woodland.

Upland Redwood Forest

The community classification system followed in this plan recognizes two types of redwood communities in the state, an Upland Redwood Forest and an Alluvial Redwood Forest. Redwood stands in the park have attributes that closely correspond to those described for Upland Redwood Forest. This community is abundant in canyon bottoms and near streamcourses at low to middle elevations of the park. Most of the park's redwood forests were harvested prior to acquisition, although a few stands of ancient redwoods in the Kings Creek drainage have escaped this fate. A high degree of soil

moisture is necessary for establishment and perpetuation of redwood forests. The humid microclimate of a redwood forest is maintained by runoff, perennial streams, and summer fog. This community intergrades with Mixed Evergreen Forest and White Alder Riparian Forest in more moist areas and with Interior Live Oak Woodland and Northern Mixed Chaparral in drier locations.

Moist sites are dominated by redwood, with fewer numbers of Douglas-fir. These locations support an understory of giant chain fern, five-finger fern, western sword fern, and redwood sorrel. On drier sites, redwood, Douglas-fir, and madrone are co-dominants in the canopy, and tanoak is a common associate. Here the understory includes false Solomon's seal, giant wake-robin, fairy bells, wild ginger, and redwood violet.

Plant Community Dynamics

Fire

Arguably, fire has the greatest potential of any natural process for altering the surface landscape of Castle Rock State Park. Fire has been, and will continue to be, a major factor in the ecology of the Santa Cruz Mountains. Documentation of fire history prior to this century is based on sketchy historical accounts of the Euro-American settlement period and supposition of aboriginal burning practices. Vegetative fuel loads in the various plant communities of the park have been increasing for a considerable time. No fires of any significance have occurred in the park during the past 20 years. A program of total fire exclusion is producing some significant and undesirable changes in the vegetation of the park. Also, both Northern Mixed Chaparral and Knobcone Pine Forest are dependent on fire for maintenance and renewal.

Floods

Floods are an important feature of riparian areas in Castle Rock State Park. Short duration flood events are a relatively common occurrence in the Santa Cruz Mountains because of intense, heavy precipitation during the winter. Constrained channels and steep topography characteristic of most of the park's streams increase flood severity. Loss of streamside vegetation is possible during intense and/or prolonged precipitation, although the White Alder Riparian Forest community is remarkably resilient to flooding.

Tree Harvesting

The park and surrounding areas were heavily logged in the 1890s, and by the end of the century most of the large, valuable trees had been removed. Most areas commercially logged have undergone a series of successional changes resulting in well developed, second growth Redwood and Mixed Evergreen Forests. Although not as

biologically unique as ancient forests, these second growth communities provide valuable wildlife habitat.

ANIMAL LIFE

Castle Rock State Park contains an assemblage of terrestrial vertebrates typical of the outer Coastal Range of central California. The large diversity of vegetation types and the wildlife habitat that they provide within the park supports a wide variety of animal species. Some of the taxa that occur in the park are considered threatened, endangered, or species of special concern by the U.S. Fish and Wildlife Service and/or the California Department of Fish and Game. However, most vertebrates occurring here are common and equally important components of the ecosystem.

Only the common names of animals are used in the Animal Life Section; corresponding scientific names appear on the Animal Species List in Appendix B.

Wildlife Habitat

Castle Rock State Park contains nine natural wildlife habitat types as defined according to the California Wildlife Habitat Relationship System (WHR) (See Map No. 2). These habitat types and the corresponding plant communities that occur within the unit appear in Appendix C, and are further described in the Castle Rock State Park Resource Inventory.

Special Habitat Features

Special habitat features occurring in many of the habitat types provide essential microhabitats for several species. Caves, crevices, and ledges associated with rock outcrops provide nesting and cover habitat for many wildlife species that are known to occur in the Castle Rock State Park vicinity. Examples include peregrine falcon, turkey vulture, golden eagle, American kestrel, ringtail, mountain lion, and others.

Ecological Corridors

Habitat fragmentation and the resultant isolation of wildlife populations lead to the local extinction of those species that can only succeed in large, contiguous tracks of habitat. It may also result in the endangerment of low-density, wide-ranging species. Species that are adapted to tolerate human-modified environments become dominant; these species are frequently exotics and/or pests.

The establishment and maintenance of habitat linkages that connect various wildlands can partially alleviate wildlife habitat fragmentation. Corridors of natural habitat, free of

roads and other development disturbances, provide wildlife movement routes between larger areas of habitat.

Castle Rock State Park lands, in conjunction with those of the San Lorenzo Valley Water District at Waterman Gap, combine to form about 5,000 acres of nearly continuous habitat. However, old logging roads and other disturbances bisect these lands, making the quality of the open space variable. Other open space lands to the north (Midpeninsula Regional Open Space District Preserves) and to the east (Sanborn-Skyline County Park) are located in the near vicinity, but are separated from the park unit by State Highways 9 and 35. Both highways may impact normal animal movements.

Historical Influence

Historic land use in the state park has included the introduction of a variety of disturbance factors that affect native wildlife populations. These include logging, tan-bark and firewood cutting, poaching, hunting, trapping, highway and residential construction, agricultural conversion, vegetation burning by Native Americans, wildfire prevention and suppression, and the introduction of exotic plants and animals. Volunteer habitat restoration projects have mitigated some of the past disturbances. The California grizzly bear, Mexican jaguar, California condor, and coho salmon no longer exist in the vicinity of the park.

Exotic Animals

Of the several species introduced into Santa Cruz County, the European starling, feral pig, brown-headed cowbird, bullfrogs and wild turkey occur in Castle Rock State Park. Feral pigs are the most pestiferous. They damage native vegetation by their rooting activities, are capable of eliminating populations of rare plants, cause erosion problems, and stimulate exotic plant proliferation. They compete with native animal species for mast and predate upon herptofauna, bird eggs, and nestlings. They also may harbor diseases that pose a health threat to other mammals in their range, including humans. Brown-headed cowbirds have increased their numbers and range into Santa Cruz County. This nest parasite has had a tremendous negative impact on the host species' populations in California. Horse-based recreation contributes to the spread of cowbirds by providing a supplemental food source to cowbirds from undigested grain in horse manure and the insects attracted to it.

Bullfrogs have been identified as a major contributor to the reduction of California red-legged frogs, a federal-listed threatened species. Bullfrogs predate upon red-legged frog larvae and juveniles, and compete with adult red-legged frog for food items.

Sensitive Animals

A list of sensitive wildlife species documented as occurring at Castle Rock State Park is provided in Appendix B. This list also includes species not documented to occur at the park, but for which appropriate habitat is available in the park and is within the natural range of the species.

Mammals

Two California Fully Protected mammal species are known to occur within Castle Rock State Park, including the ringtail and the mountain lion. A Species of Special Concern is known to occur in the vicinity of the park (Townsend's big-eared bat). Three other special status bat species are suspected of occurring within Castle Rock State Park based upon the known range of the species and the presence of suitable habitat at the park (See Appendix B).

Birds

Castle Rock State Park provides habitat for numerous bird species. Of the species documented using the park, 22 hold special status. Two are listed on Federal Threatened list, one is listed on the Federal Endangered list, one is listed on the California Endangered list, and 17 are California Species of Special Concern. One species is listed as California Fully Protected. Several of these species occur on more than one sensitivity list (See Appendix B).

Reptiles

Two sensitive reptiles have been documented to occur within the vicinity of Castle Rock State Park: the western pond turtle and the California horned lizard. Both are Species of Special Concern.

Amphibians

There are 4 species of special status amphibians that have been documented in the park or within the park's vicinity. Of these, the California red-legged frog, a Federal listed Threatened species, is known from the vicinity and is most likely to occur in appropriate habitat types in the park. The leopard frog and the foothill yellow-legged frog, both Species of Special Concern, possibly occur in the park but their presence there is unknown. The Federal listed Endangered tiger salamander may occur in the park, but the paucity of suitable habitat in the park suggests that its presence is unlikely.

AQUATIC LIFE

The aquatic resources of Castle Rock State Park are associated with the headwaters area of the San Lorenzo River. The park unit contains a complex network of tributaries to the main stem of the San Lorenzo River. Within the park, Craig Springs Creek, Tin Can Creek, and several small unnamed tributaries empty into the river. The headwaters of Kings Creek and its tributaries, and an intermittent tributary to Deer Creek, also originate in the unit, but join the main stem San Lorenzo River downstream of park boundaries.

The San Lorenzo is a major river of the central California coast that supports a well-documented fishery. Only about 1 mile of the stream, mostly intermittent, is upstream of the park unit. Once inside the Castle Rock State Park boundary, the permanent river flows approximately 1.5 miles before leaving the unit.

Within state park boundaries, the river provides habitat for native anadromous and resident rainbow trout, the Pacific giant salamander, Pacific tree frog, California newt, rough-skinned newt, and western toad. Other species that may occur in the vicinity of Castle Rock State Park are the California red-legged frog and western pond turtle. Wild runs of coho salmon have been extirpated from the San Lorenzo River system.

Kings Creek provides permanent aquatic habitat for the same species composition that occurs in the San Lorenzo River, except fish. Downstream barriers prevent steelhead from entering the reach of Kings Creek within Castle Rock State Park.

The canyon slopes within the park have several widely scattered springs and seeps that provide important watering sites for wildlife. Many of these springs are the origins of both major and minor tributaries to the San Lorenzo River and Kings Creek.

The aquatic communities of Castle Rock State Park are generally less complex than those typical of the lower San Lorenzo River. At least 20 species of fish have been documented downstream of the park. However, there has been no meaningful sampling of the reach of river within the park boundaries prior to the inventory for this plan. Only one species, rainbow trout, was identified in the river during inventory efforts at the unit. Rainbow trout are separated into two forms: an anadromous form, called steelhead, which is sea-going, returning to freshwater streams to spawn; and a resident form, typically called rainbow trout, that resides in freshwater streams throughout its life. Both resident and anadromous forms of rainbow trout successfully spawn in the park. Steelhead are a Federal-listed Threatened species in the San Lorenzo River.

ECOLOGY

Castle Rock State Park encompasses seven different ecological units (EUs). These EUs constitute ecosystems whose boundaries were based primarily on the identification and analysis of watersheds and hydrological processes. They encompass both disturbed and undisturbed parts of the systems. The functioning of one ecological unit depends to some degree on the functioning of the others, so definitive boundaries between ecosystems are somewhat artificial.

Ecological Units identified for Castle Rock State Park include: the Aquatic and Riparian Complex, Upper Kings Creek Watershed, Upper San Lorenzo River Watershed, Pescadero Creek Watershed, Deer Creek Watershed, Saratoga Creek Watershed, and Upper Stephen's Creek Watershed. Refer to the Ecological Units Map No. 3 for an orientation to the locations and geographical extent of these Ecological Units. Descriptions of Ecological Units can be found in the unit Resource Inventory.

PHYSICAL RESOURCES

Topography

Castle Rock State Park encompasses a portion of the central Santa Cruz Mountains, primarily in the upper San Lorenzo River basin. Its varied topography includes moderate to steep mountain slopes, relatively deep canyons, and level to gently rolling ridgetops. Elevations range from about 880 feet above sea level along the San Lorenzo River to the 3,214 foot summit of Castle Rock near Skyline Boulevard. Slopes vary from slight (0-8%) to greater than 50%, although most of the park has moderate to steep slopes.

The moderately to steeply sloping upper San Lorenzo River basin dominates the topography of the park. This southward-facing basin is dissected by several streams, including the two largest park streams, the upper San Lorenzo River and its tributary, Kings Creek. Higher elevation reaches of park streams are typically steep and confined in narrow canyons. The noteworthy Castle Rock Falls is located on Kings Creek, at its headwaters.

Castle Rock Ridge circumscribes the heads of the San Lorenzo River and Kings Creek drainages. This ridge is a major divide separating drainages of the San Francisco Bay area and the Pacific Ocean. Most of Castle Rock Ridge exceeds 2,600 feet in elevation. A portion of this ridgecrest is situated within park boundaries. Skyline Boulevard generally runs parallel to or along the ridgecrest from Saratoga Gap to the park's southeastern boundary near Mt. Bielawski.

Castle Rock Ridge exhibits a rolling topography of mostly rounded summits interspersed with a few more sharply defined peaks. One of the most prominent

features is Castle Rock, a large sandstone outcrop with a near vertical south face. Other notable rock outcrops in the park, such as Goat Rock, are located on this ridge or subsidiary ridges and canyon walls.

The western and northwestern boundaries of the park are primarily delineated by a ridge separating the Pescadero and Oil Creek drainages from the San Lorenzo River. This ridge ranges in elevation from about 2,600 feet at the northern tip of the park (Saratoga Gap) to about 1,300 feet at the southwestern corner of the park (Waterman Gap).

Meteorology

The climate of the Santa Cruz Mountains varies over relatively short distances because of diverse topography, although the proximity of the Pacific Ocean moderates some extremes of climate. Generally, an increase in elevation and distance from the coast produces a corresponding increase in precipitation and temperature maxima/minima. Winters are typically cool and wet, while summers are dry and warm to moderately hot. Summer fog is an important component of the park's climate at lower elevations, especially in the valleys.

The average annual temperature in the area of the park is 56°F. The highest and lowest recorded temperatures are approximately 100°F and 20°F, respectively. The January mean maximum is 57°F, and the mean minimum is 37°F. In July the mean maximum and minimum are 82°F and 54°F, respectively. Freezing temperatures can be expected from late November to late March.

Average annual precipitation for the Castle Rock area ranges from 40 to 50 inches, with an average of 50 days per year having 0.1 inches or more. However, precipitation in the Santa Cruz Mountains can vary greatly over short distances. For example, the average yearly precipitation ranges from 31.25 inches on the coast in Santa Cruz to 54.50 inches nine miles inland at Ben Lomond (500 foot elevation). Orographic influences account for most of this increase. Most of the rain falls between November and May.

Hydrology

Castle Rock State Park is primarily within the San Lorenzo Hydrologic Subarea (HSA) of the Santa Cruz Hydrologic Area (HA), as defined by the Department of Water Resources. The Santa Cruz Hydrologic Area lies within the Central Coast Hydrologic Basin (HB). Relatively small portions of the park along the northwest and northeast ridgetop areas occur within two distinct hydrologic areas of the San Francisco Bay Hydrologic Basin.

The greater San Lorenzo River watershed covers about 97,280 acres. About 3,670 acres (3.8%) of this total are in Castle Rock State Park, draining nearly the entire unit. The upper San Lorenzo River and several of its tributaries provide drainage for the northwestern half of the park. Kings Creek and Deer Creek drain the southeastern half. Approximately 1.9 square miles of the Kings Creek drainage occurs on state park property. Both creeks flow into the San Lorenzo River downstream of the park.

Castle Rock State Park contains many springs, which do not directly feed streams during most of the year. Many of these wet, seepy areas are associated with active as well as ancient landslides. The abundance and persistence of springs within the unit indicates the presence of widespread water-bearing geologic strata with slow horizontal permeability. However, it is also reasonable to assume that additional development of groundwater resources within the unit may reduce the production of any springs that rely on common water-bearing formations. One small group of springs, known collectively as Travertine Springs, are a rare form in Santa Cruz County in that they issue deposits of calcium carbonate where water surfaces.

The narrow floodplains along the San Lorenzo River in the southern part of Castle Rock State Park are subject to seasonal flooding. The severity of habitat damage from some floods can be intensified by unnaturally large quantities of sediment destabilized by decades of human land uses in the watershed, as described in the Historic Resources section of this report.

Small earthen dams and associated reservoirs (<0.2 acres each) are located on 2 tributaries to the San Lorenzo River. One dam occurs on Tin Can Creek; the other on an unnamed creek in the Partridge Farm area of the unit. While sediment volume in the ponds is unknown, dregs have accumulated for decades. These sediment loads appear to be large enough to deliver significant damage to downstream aquatic resources, should the unmaintained dams fail.

Geology

The rocks underlying Castle Rock State Park are a portion of a northwesterly trending belt of Cenozoic rocks that range in age from 25 to 60 million years. These rocks are predominantly marine sediments, with minor inclusions of submarine and surface volcanics. They are bounded on the east by the San Andreas Fault and on the west by the San Gregorio Fault.

The belt of Cenozoic rocks is comprised of 13 separate formations, with a composite thickness of about 30,000 feet. Six of these formations crop out in the park, the most extensive being the Vaqueros Formation, which is a ridge-former that weathers into cavernous escarpments.

Castle Rock State Park is part of a structurally complex system of folds and faults bounded by the San Andreas Fault on the northeast and Ben Lomond Mountain on the southwest. The major structures of the complex are roughly parallel and have a northwest/southeast orientation. One of the most prominent folds is the Waterman Gap anticline, which passes through Fat Buck Peak and Waterman Gap. The other prominent fold is the Castle Rock anticline in the vicinity of Castle Rock. Anticline is a term applied to rock strata which dip in opposite directions from a common ridge or axis, like the roof of a house.

The trace of the San Andreas Fault lies about 1.5 miles north of the park's northeastern boundary. Twelve miles west is the San Gregorio Fault, which is the major offshore branch of the San Andreas. On the south boundary of the park, the Butano Fault extends in a southeast direction from Waterman Gap to Kings Creek and beyond. Within the boundaries of the park and roughly paralleling the Butano Fault are the Fat Buck, Sleeper Gulch, Oil Creek, and Deer Creek Faults.

The Castle Rock State Park area is in a region of high seismicity. Both the San Andreas and San Gregorio Faults are considered active. Ground displacement has occurred on both these faults either in historic time or within the most recent period of geologic history (past 11,000 years). An earthquake up to a magnitude of 8.5 on the Richter scale can be expected to occur along the San Andreas Fault within the next several decades. The San Gregorio Fault is capable of generating an earthquake of magnitude 7.2 to 7.9 with horizontal movement, and up to 8.5 if significant vertical movement also occurs.

The risks of landslides in Castle Rock State Park are significant, especially for those that are earthquake-induced. Two slides in the park area were triggered by the 1906 San Francisco earthquake. Major seismic events are chiefly responsible for this type of landslide, known as a rock slide avalanche. Other factors contributing to landslides include slope angle, high ground water, and human activity such as road construction and maintenance. More than one factor acting together substantially increases the risk. Some 294 landslides of six different types have been mapped in the area of the park. These landslide types are slumps, debris slides, combination slides and slumps, rock slides, combination rock and debris slides, and rock slide avalanches.

Several geological features of special interest can be found in the park. The rare cavernous weathering of sandstone known as tafoni occurs in outcrops of the Vaqueros Formation and to a lesser extent in the Butano Formation. Outcrops of these two formations are popular with rock climbers. Castle Rock, for which the park is named, is one of the most recognized and visited rock outcrops. Differential weathering of sandstone has also produced large spheroidal masses that resemble "cannonballs" and stone lattice or fretworks that are believed to be formed by the same process as for tafoni.

Soils

Castle Rock State Park is located in the Northwestern Coast Ranges Soil Region (Soil Region I). Soil Region I encompasses steep mountain ranges and small valleys of the Coast Ranges from the Santa Cruz Mountains north to the Oregon border. This region has a temperate climate of cool, dry summers and wet winters with moderate temperatures. Soils in Region I are primarily derived from sedimentary rocks, alluvium, and granitic rocks.

Seventeen soil mapping units representing 10 soil series occur in the park. Soils in the park are derived from sedimentary, metasedimentary, and metavolcanic rocks. They range in depth from shallow to moderately deep or deep. Most soils are well drained, although soils of the Sur and Maymen series exhibit excessive drainage. Erosion hazards are primarily moderate to high because of the preponderance of steep slopes in the park. The most common soil mapping unit in the park is the moderately deep Sur-Catelli complex, 50 to 75% slopes. It covers extensive areas in the uppermost watershed of the San Lorenzo River drainage.

The U.S. Department of Agriculture Natural Resources Conservation Service has determined the limitation or suitability of soils that occur in Santa Cruz and Santa Clara Counties. Potential land uses that have applicability for DPR units are septic tank absorption fields, roadfill, roads, shallow excavations, dwellings without basements, picnic areas, paths and trails, and camp areas. Soil limitation ratings are severe for all these uses on every soil except for soils occurring on prairie-covered ridgetops, which have slight limitations for paths and trails and moderate limitations for other uses. The most common limiting factor is slope.

Dark Skies

Although not often recognized, dark skies are a significant natural resource, especially for the urban dweller of the Santa Clara Valley seeking a place absent of light pollution sources so common in the metropolitan areas of the Santa Clara Valley to the east. Castle Rock State Park is a good location for viewing dark skies. The park's distance and orientation away from the city lights creates favorable conditions along Skyline Boulevard for this type of activity. Support facilities, such as parking and restrooms, and other developments can increase light pollution and require design considerations to minimize impacts.

CULTURAL RESOURCES

PREHISTORIC RESOURCES

Prehistory

Prehistoric occupation of the region of which Castle Rock State Park is a part, can be dated to 3000-2000 BC and is known as the West Berkeley Culture. Evidence of the earliest inhabitants has been reconstructed from archaeological excavations conducted at several San Francisco Bay locations. The evidence shows that permanent villages were common along the coast and bay shores, and that inhabitants supported themselves by collecting shellfish, fishing, hunting, and gathering plants. Temporary camps in the Santa Cruz Mountains, such as found at Castle Rock State Park, show that acorn collecting and hunting were important seasonal activities away from the bay and coastal areas. Artifact assemblages for this period include milling stones, mortars and pestles, chipped stone tools, bone implements, and shell ornaments.

Later archaeological evidence for the Middle and Late Horizons show that permanent villages became more common along the coast and bay shores. Sea-mammal hunting became a more important aspect of the marine-adapted economy. Mortars and projectile points are indications that plant food gathering and hunting continued to be important subsistence activities into the protohistoric period.

Previous Investigations

Prior to preparation of this general plan, only one previous cultural resource study had been conducted at Castle Rock State Park. In 1982, the Sempervirens Fund commissioned an archaeological and historic inventory of the Boisseranc Unit; a portion of which is referred to as the Partridge Farm area. A number of historic features were identified, as well as six prehistoric archaeological sites.

Previous studies in this region have concluded that there is a low potential for prehistoric archaeological sites in Castle Rock due to several factors. Most of the park unit contains extremely steep terrain. Food resources would have been relatively scarce and would have been confined to the relatively open oak woodlands along the ridge, riparian zones near the San Lorenzo River, finger ridges, small terraces, and within meadows at higher elevations. Soil conditions are conducive to landslides. Archaeological sites, which may have been present, would be difficult to identify today due to unstable soils and the rapid formation of soil in highly-vegetated areas.

Inventory Procedures

A limited archaeological reconnaissance was conducted for this general plan effort. The object of this inventory was to survey those areas being affected by current use and areas likely to be affected by general plan proposals. These areas include existing roads and trails, the Waterman Gap trail camp, the main Castle Rock campground area, the Partridge Farm area, and the area surrounding the parking lot at Castle Rock. With the exception of the Partridge Farm and the main Castle Rock campground, most of the area surveyed was in steep terrain and heavily vegetated with chaparral and mixed conifer forest. Leaves and duff covered most of the ground surface. No new prehistoric archaeological sites were identified, however, a number of historic resources were discovered in the unit.

The large rock formations in the park were not included in this inventory. Future resource management programs and climbing management plans will precipitate further investigations. These rocky areas may contain significant prehistoric rock art and shelters that may be affected by rock climbing activities.

Description of Prehistoric Resources

The six previously known sites (CA-Scr-255, -256, -257, -258, -259 and -260) in the Partridge Farm area could be considered as separate components of a single activity area, being distributed along a single stream and in relatively close association. This cluster of sites can be interpreted as being a seasonal camp of undetermined age. The primary components of this cluster are: midden soil surrounding a large outcrop of rock with mortar depression, mortar depressions in rocks scattered along a stream bed, a scatter of Monterey chert and quartzite flakes, and a quartzite core tool. Although these resources have been adversely affected by “pre-park” building construction, roads, agricultural activities and land modification, they are collectively considered to be significant and potentially eligible for the National Register of Historic Places. The cluster of sites contains information important to the understanding of prehistory, and study of the data in the cultural deposit can advance our knowledge of events that have made a significant contribution to the broad patterns of our history.

Overall, there is a low potential for the presence of other prehistoric archaeological resources within the project area.

NATIVE AMERICAN ETHNOGRAPHIC OVERVIEW

The Native Americans who inhabited the Castle Rock region are now known as either Costanoan or Ohlone. In prehistoric and protohistoric times, that is prior to 1770, they lived throughout the San Francisco and Monterey Bay Areas. The ancestors of the Costanoan, speakers of a Penutian Language, were probably the producers of the

artifacts contained in the Late Horizon components of the archaeological sites of the San Francisco Bay Area. They are thought to be later arrivals to these territories, some 1,500 years ago, displacing an earlier Hokan-speaking group of Native Americans.

The terms Costanoan and Ohlone are modern terms. Costanoan was a term first applied by the Spanish, and is of Spanish derivation meaning “people of the coast.” Ohlone is recently derived from a village: Olxon. It is a term chosen by many of today’s descendants of the Costanoan-speaking peoples to have a non-foreign term of reference for themselves. Of the seven major Awaswas Ohlone tribes or villages, the Achistaca, who were located near present day Boulder Creek and Riverside Grove of the upper San Lorenzo River area (and may be the same as the Acsaggis near Saratoga Gap) are of concern to Castle Rock State Park. Also of some concern are the Partacsi, Tamyen Ohlone speakers, who were located at Saratoga Gap.

An Ohlone tribal village averaged about 200 people, with seasonal hamlets often scattered through the tribe’s territory. Hunting was usually a cooperative effort. Generally, fishing and gathering of fish and shellfish, like hunting, were the domains of the men. The women’s responsibilities, generally, were with plant harvesting and food preparation. Seed producing plants and leafy vegetable plants were encouraged through careful management of the land. Selective and controlled burning of extensive areas of land was carried out each fall. Fresh re-growth from burned-over meadowlands also attracted grazing deer, making hunting easier. This annual burning retarded the growth of chaparral species and prevented the accumulation of large quantities of dead plant material, which would have posed a serious fire threat. Now the ridges and meadowlands of Castle Rock show slight remnants of the two Native American cultures and their activities.

Spanish incursions into Ohlone territory began in 1602 when an exploration party led by Sebastián Vizcaíno encountered the Rumsen Ohlone in the Monterey area. Various Spanish expeditions explored Costanoan territory between 1769 and 1776, and Franciscan priests founded seven missions in Costanoan territory. The plan of the mission system was that after about ten years the missionaries would withdraw to be replaced by parish priests in the mission churches. The land and the mission factories were to be turned over to the mission’s Native Californians who would then own them. This never happened.

Mission Santa Cruz was located in the midst of Awaswas Ohlone territory, but many of the Awaswas had previously been drawn into the spheres of San Carlos, San Francisco, and Santa Clara missions in earlier years. Any remaining disruption that had not occurred to their way of life was finalized with the founding of Mission Santa Cruz in 1791. From that time on there was probably little or no association of the Awaswas or any Ohlone with the land we now call Castle Rock State Park.

HISTORIC RESOURCES

Euro-American History

The demand for firewood and building lumber by the citizens and towns of the Santa Clara Valley produced a road over the summit from Saratoga to the San Lorenzo Valley in 1870. Prior to this entry, the Castle Rock area had been visited by tanbark choppers, hunters, and an occasional settler in the lower or southern portion of what is now the park. A brief, non-financially rewarding “gold rush” rocked the upper San Lorenzo in 1855. Prospecting was soon over, but it did leave the earliest known place name, “Tin Can Springs”. Potential mining claims were made over the next six decades, but none proved valid. The area was opened for settlement with the opening of the Saratoga Toll Road (also known as the Saratoga-Pescadero Turnpike) over the summit and down the San Lorenzo Valley.

Summit Ridge and its slopes were remarkably bare of timber. Wood choppers supplying the cooking fires and heating stoves of the valley to the east had worked up and over the ridge beginning in the late 1860s. A trail, or narrow road, snaked along the top of Summit Ridge and today it is known as Skyline Boulevard or State Highway 35.

There were two earlier horse trails, apparently only occasionally used by horseback travelers. Along Damon Ridge, there was a trail noted in federal survey records (1868) as the “Santa Clara” or “Santa Cruz Trail”. A second trail was well known, as it traversed the ridge from the gap at the summit to the “Waterman Gap” area. This trail was known for James “Buckskin” Lawrence. It disappeared under the Carmichael and Hubbard Logging Company logging road, which became John W. Chace’s road and later part of Highway 9 in 1916.

The Saratoga Toll Road crossed the “Gap” at Summit Ridge in 1870. William S. Brewer built a toll station and developed a tavern, with bar, restaurant, and “hotel” at this location. As work on the Saratoga Toll Road progressed down the north side of the upper San Lorenzo Valley, William H. Hall installed a roadside resort that served as a rest stop for travelers just below the modern intersection of the Saratoga and “Beekhuis” Roads. The County bought the right-of-way, and opened the road to the public in 1891 (See Cultural Resources Map No. 4).

Landowners came slowly. The first were speculators claiming the redwood forest between the San Lorenzo River and Pescadero Ridge (1870s). However, it was a quarter of a century before Boulder Creek loggers actually pushed into the area. When the logging companies arrived in the mid-1890s, it took only five years to totally harvest the redwood forest of “the San Lorenzo Gulch”. This left Douglas-fir for the fruit box industry in the Santa Clara Valley and oaks and madrones for tanbark and firewood choppers. The last commercial logging in the Castle Rock portion of this area took place in the early 1970s.

In the mid-1880s, speculators or farmers, unable to afford property in the Santa Clara Valley, began to claim land along the slopes of Summit Ridge. Taking Homestead Act of 1862 options or buying the land outright from the federal government, domestic settlers carved 120-160 acre farmsteads out of the open, dry, rocky soil. Vineyards and orchards of apples and pears were planted. On the fringes of these farms in areas not suitable for large scale orchards, a new type of owner joined the community, the weekend recreationist. Some of these urban types bought the land on the speculation that lumber companies would buy the timber footage existing on their isolated pieces of property, or that having a parcel near a proposed road, particularly a new road leading to Big Basin Redwoods State Park, would bring the development of a community. Two communities were planned; both failed. Today's "Indian Rock Ranch" community did not appear until the late 1960s.

The acquisition of the Redwoods State Park (Big Basin Redwoods State Park) in 1902 led a sixteen year movement to create a highway, which connected Saratoga and the Saratoga Gap with Big Basin along the top of Pescadero Ridge. The Sempervirens Club led the way, and finally in 1916, following old horse trails and lumber roads, what became State Highways 9 and 9A (into Big Basin) were built. The highway alignment has been widened and improved a number of times since 1927.

The agriculturalists of the Castle Rock area fought a long battle of survival (1885-1960s). Lack of irrigation and weather conditions caused their produce to ripen late in the year at the very end of canning season. Often the canneries were closed before wagons of apples, pears, and grapes came down off Summit Road. The last of Santa Clara Valley's canneries had closed in 1955. The few farmers left in the Castle Rock area turned to growing and selling Christmas trees. Today (1998) only one Christmas Tree farm is still in business.

The era of the "Cold War" between the U.S. and the Soviet Union initiated the development of a military facility at the Loghry residence area. The Navy leased nine acres at Loghry State Forest and established a radio relay station on the highest point to conduct submarine patrols and relay to Moffett Field. With the development of orbiting satellites, the relay station passed into obsolescence and the site was abandoned. The Department of Forestry then used several of the concrete buildings for fire suppression training. Although the facility is no longer used for fire training, the site is still sealed off from the public by a chain link fence controlled by CDF&FP and this portion of the site is currently not within the state park boundaries.

As far back as the late 1800s, visitors began arriving to experience the beauty of a rejuvenating landscape. As well, visitors could enjoy camping on the summit via a one or two day buggy ride along what was known as "Twenty-seven Mile Drive." By the end of the century, hikers were coming up the Saratoga Road from Congress Hall Lodge to the Summit. Seeing it at that time in its most open and heavily disturbed condition, they must have been struck by the far reaching vistas of the rugged, if marred, landscape.

When Judge Joseph Welch of San Jose purchased a 60 acre parcel on Castle Rock Ridge in 1908, logging was still shattering the stillness downslope. Logging would continue in some parcels until the early 1970s. However, Welch established a precedent by making "Castle Rock" and a few acres around the rock available for those who enjoyed the beauty of the world. Camping at the rock was also allowed by Welch. With the help from Russell Varian, the Varian Foundation, Sierra Club, and others, Castle Rock became a state park in 1968.

Historic Sites and Features

Gold mining, lumbering, agriculture, farming, and recreation brought people into the area for over a hundred years before the initial park acquisition of the property in the late-1960s. Few obvious historic features remain of those many activities. The following represents a summary of these various historic features.

Partridge House: This house is typical of the farm bungalow-style of the 1900-1935 era. The house was built in 1924 and represents the living style of the farmers of Summit Ridge and the Castle Rock area during the decades since 1900. A rear porch was removed after 1979, and a front porch was recently added. This structure is considered historically significant because it is a good representation of the bungalow architectural style and is associated with important local events of early agricultural activities in the Santa Cruz Mountains.

Historic Orchards: Remnants of historic orchards exist at two locations: the Smead Parcel just southeast of Mt. Bielawski summit and the Partridge Farm area. When the Department obtained the property at Partridge Farm, there were 10 acres of orchards. Currently, this area contains about 2 acres of old apple and pear trees, as well as new varieties of English walnuts and apples. The existing 17 apple and 3 pear trees may be approaching 100 years in age. They may represent the oldest remaining fruit trees on the ridge and some of the oldest and last remaining trees in the general area that include Santa Clara Valley. Little is known about the orchard on the former Smead Parcel. Trees in both orchards may be significant as representative of the early fruit industry in the Santa Cruz Mountain region.

Hall's Rest Stop Site: This site was originally a roadside rest stop or tavern on the Saratoga Toll Road and was used from 1872 to 1885. It is believed that this site lies near the junction of the Toll Road and Beekhuis Road. Evidence of historic use here is apparent from the large patches of periwinkle, a non-native plant which is commonly found at historic sites in Northern California woods. No visible features or artifacts were identified here due to the heavy cover of vegetation and duff. The site is potentially significant in that it may possess archeological information important to the understanding of the activities and structures that existed and the traffic on the road during the first decades of use.

Travertine Springs: Near the spring is recent refuse that has been determined to be associated with a work camp, probably a PG&E construction crew for the nearby powerlines. Although no significant cultural resources were identified here, the presence of a perennial water supply indicates that evidence of older historic and prehistoric activities may exist under the heavy duff.

Tin Can Springs: The earliest historic site and place name in the unit, “Tin Can Springs”, reflects the earliest economic pursuit in the unit, the short-lived “gold rush” of 1855. The site is located just uphill from the Saratoga Toll Road where it crosses Tin Can Creek. The site has been heavily damaged by construction of a small reservoir. No significant artifacts or features were discovered.

Louis Seek - A. F. Craig Cabin Site: This site lies adjacent to the Saratoga Gap Trail just northwest of the main Castle Rock campground. Old fruit trees of an undetermined variety grow on a flat just northwest of the trail/road. It is suspected that archaeological evidence of structures, barns, and outbuildings lie in this area. This area was not inspected closely due to thick patches of poison oak and heavy duff cover.

Loghry Woods Demonstration Forest: The Woods are on both sides of State Highway 35 in the northeast section of the park. The present focus of the Loghry Woods is on the east side of the highway. These woods represent the kind of individual and group efforts that are part of the history to save lands for various public uses. The Loghrys planted a demonstration forest of non-native trees and then presented the forest to the Department of State Forestry (currently known as the California Department of Forestry and Fire Protection). This State Forest eventually became part of Castle Rock State Park. Some trees are a genetic threat to plant species in the area or are invasive to areas outside the boundary of the woods. Also within the bounds of the forest, but still owned by State Forestry, are buildings built by the US Navy for a radio transmission center during the “cold war.” It was later used by the Forestry Department for fire training. Both of these functions have interpretive value.

Historic Logging Features: Primary lumber products camps, noted by artificial flats, pads, skid trails, roads, and material cultural debris are scattered throughout the unit. One shingle camp located on a minor tributary to Kings Creek (previously known as “Deer Creek” where it passes through Hugh McDonald’s property) has potential historic significance as a preserved time capsule of April, 1906. Two brothers were killed, and the camp buried, on the morning of the great “San Francisco earthquake.” A more detailed inventory and inspection of these areas was considered to be outside the scope of this general plan.

Other Cabin Sites: Beginning in the early 1890s, parcels were purchased by individuals interested in the recreational benefits of the area. While many owners leased timber rights of a given section of land, the real intent was to enjoy the peace and beauty of the area. Most of them built cabins, often with horse barns and associated out-buildings and corrals. Additional roads were constructed for access to these weekend or summer

retreats. Several recreational cabin-cottage sites, plus cabin sites of former orchardists or absentee owners, lie within the unit. All but one of the cabin sites have been recorded and determined not to be historically significant. The cabin site of an early homesteader, Rosetta Damon, could yield additional information to determine its historical significance, but it has yet to be found.

Other Potentially Significant Historic Sites: The location of the Saratoga Gap toll station (i.e. Brewer's Station) and the last Castle Rock District school and precinct house cannot be positively located due to modern road and parking lot improvements.

Saratoga Toll Road: This historic wagon road served various economic activities along the flanks of the San Lorenzo River from 1871 until the construction of Highway 9 in 1916. The Department of Parks and Recreation currently administers the use on the Saratoga Toll Road as an equestrian and hiking trail. The upper portion of the road is reduced to a narrow trail, affected by landslides and erosion. Other portions are maintained for authorized vehicle access. Overall, the route remains intact and has been modified very little since its use as the Toll Road. This old wagon road is historically significant due to its location in the northwestern portion of Santa Cruz County and its role in opening portions of this area to the lumber business and encouraging various settlement patterns of Santa Clara County.



Bridge, Saratoga Toll Road

Other Historic Roads

Four historic routes should be considered historically significant because they opened the interior of the unit primarily from Summit Ridge and Summit Road (now State Highway 35) to farms, logging parcels, retreats, and summer residences. They are associated with early settlers in the region. Their routes trace primary inhabitancy patterns in Castle Rock State Park.

Smead-Damond-McDonald Road (a.k.a. the Kings Creek Truck Trail): This road was originally constructed in 1885 for access to orchards and recreational cabins. This private road is currently used as a service and fire road. Though the road has been graded many times, it still maintains its original route. No significant artifacts nor associated features were identified during the inventory.

James Archibald McDuff Craig Road: This road was built by Craig in 1905-06 to gain access from Summit Road to the four room cottage he built on the site of Louis Seek's cabin. The road is regularly graded and used as a fire road and as a service road to the campground. A small section is used for the Saratoga Gap trail. Fruit trees and the archaeological remains of the Craig homesite may lie adjacent to this road just northwest of the campground.

Louis Seek Road: This road was originally constructed by Louis Seek to connect his one room cabin to Saratoga Gap. The dirt road serves as a portion of the Saratoga Gap trail and extends from just west of the Castle Rock campground to the property line with the Indian Rock Ranch community. A portion of the original route is paved from the park boundary to its junction with Highway 35 near Saratoga Gap. Archaeological remains of the Seek cabin may exist adjacent to the road just northwest of the campground.

John W. Chace Road: Originally this route was a trail used by James "Buckskin" Lawrence in the 1860s. It was later improved by the Hubbard Logging Company to serve as a logging road. This route originally traversed the top of Pescadero Ridge from Saratoga Gap to Waterman Gap. When Highway 9 was constructed in 1916, it was almost completely overlaid by new construction and is currently comprised of small turnouts or former bends. Without further scientific study, these segments are indistinguishable from the early gradings of Highway 9. Significant artifacts or features may be present in these small sections.

EXISTING FACILITIES

The location of existing park facilities are shown on the Existing Conditions Map No. 7.

EXISTING TRAILS

The park offers over 34 miles of hiking trails, ranging from short walks, to longer trails used by hikers, backpackers, and equestrians. Most use occurs on trails near the main parking lot, including the Saratoga Gap Trail - Ridge Trail loop and the Skyline Trail. Lesser use is made of the trail system as it diverges from the main parking lot, with the Skyline-to-the-Sea Trail receiving moderate use and the Saratoga Toll Road having light use (See Table 3 in Appendix E for list of park trails).

The Saratoga Toll Road Trail provides a trail route for hikers and equestrians between Saratoga Gap and Waterman Gap in the redwood/Douglas-fir forest in the San Lorenzo River watershed. In contrast, the Ridge and Saratoga Gap Trails provide ridge-top views of the San Lorenzo River and Kings Creek canyons and traverse areas of chaparral and mixed evergreen forest.

The Skyline-to-the-Sea Trail descends for approximately 30 miles from the Saratoga Gap Junction at Highways 9 and 35, down through Big Basin Redwoods State Park to Waddell Beach on the Pacific Ocean. The trail offers many sweeping vistas, a wide variety of plant communities, and overnight trail camping (with 6 campsites in Castle Rock State Park at Waterman Gap).

EXISTING PARKING FACILITIES

The primary entrance to Castle Rock State Park is at the main parking lot off State Highway 35, 2.5 miles south of Saratoga Gap. State Highways 35 and 9 border the park's east and west boundaries for 9 miles, providing access to 35 roadside parking areas, trailheads, and vista points. Besides automobiles, motorcycles, and recreation vehicles, the highway corridor is shared with hikers, equestrians, and bicyclists. Trails parallel both highways and cross at a few different locations, connecting to a regional and local trail system. The total capacity of roadside parking areas in the vicinity of Castle Rock State Park, including the main Castle Rock parking lot, is 439 cars. Roadside parking is available to park visitors during daylight hours without charge. A list of available roadside parking locations and their estimated parking capacities is shown on Table 4 in Appendix E.

The main Castle Rock parking lot will accommodate 55 cars including 2 parking spaces for visitors with disabilities. Its location provides visitors with off-highway parking and easy access to trails and scenic overlooks, as well as Castle Rock, Goat Rock, and

other popular rock climbing areas. An entrance kiosk, single vault toilet, picnic site, telephone, and trailhead information panel are provided.

The parking lot is closed at sunset for day use, but provides overnight parking for backpackers to the Castle Rock Trail Camp 3 miles away. It will fill to capacity during holidays, busy weekends, and good weather days. During peak use periods, the visitor demand for parking often exceeds the current parking capacity of the main lot and nearby roadside parking along State Highway 35. This overflow can result in illegal parking along the highway and on nearby private properties.

Free daytime parking is currently allowed for 35 cars on the highway's west shoulder, located immediately south of the parking lot entrance. A roadside parking area on the opposite side of the highway, approximately 500 feet south of the parking lot entrance, can accommodate 20 cars for access to Indian Rock and the Skyline Trail. The roadside areas to the north and east of the parking lot are posted "no parking at any time." When parking is available along the highway, visitors will often park outside the main parking lot to avoid paying the day use fee. As well, some people choose to park inside the lot and pay the fee because of the extra security provided by the presence of park staff and to support the park.

At Sempervirens Point, 2 miles west of Saratoga Gap, is a roadside parking area and vista point that accommodates approximately 30 cars. Parking improvements were designed and funded prior to the start of this general plan for implementation in 1998. These improvements will include paving, striping, walkway, interpretive panels, toilet, and parking for 21 cars and a bus. This parking provides the only vista parking located along Highway 9, with southern views of Castle Rock State Park, the greater San Lorenzo River watershed, and distant Monterey Bay.

On the southeast corner of the intersection of Highways 9 and 35 at Saratoga Gap is a 50 car parking lot owned and maintained by Caltrans. This vista point parking serves as a trailhead for users of the Skyline Trail and regional trails north and east of Castle Rock State Park. Across State Highway 9 in the Saratoga Open Space Preserve, an interpretive panel provides information and maps on the Bay Area Ridge Trail and open space preserves to the north. These trails serve multiple uses, including horseback riding, bicycling, backpacking, and hiking. During weekends and fair-weather days, this parking lot becomes an active staging area for mountain biking in areas surrounding the park.

EXISTING CAMPING FACILITIES

Castle Rock State Park has two backpack trail camps: the Castle Rock Trail Camp (23 sites) and the Waterman Gap Trail Camp (6 sites). The Waterman Gap Trail Camp is located approximately 6.3 miles from Saratoga Gap in a dense forest of redwood, oak, and madrone. The campground is partially located off state park property, by

agreement with the San Lorenzo Valley Water District. The 6 campsites are accessible from the Skyline-to-the-Sea Trail for backpackers, and a dirt road provides access for service vehicles a short distance from State Highway 9. The campground has one vault toilet but no permanent supply of drinking water. Campsites are available by reservation and fires are not permitted.

The Castle Rock Trail Camp is located along the Saratoga Gap Trail in a knobcone pine forest approximately 2.6 miles northwest from the Castle Rock Parking Lot. There are 23 hike-in campsites available; each has its own camp table and fire ring. Nearby is a campfire center (50 people), two vault toilets, and piped drinking water. A covered shelter, constructed by the Boy Scouts of America with donated materials, is available for camper's use during inclement weather; no reservations are required. Fires are permitted only in designated fire pits during the off-fire season. Bicycles are permitted access to the trail camp on the Service Road Trail from State Highway 35.

EXISTING OPERATIONS & FACILITIES

Castle Rock State Park is part of the Mountains Sector of the Santa Cruz District, which includes Portola Redwoods and Big Basin Redwoods State Parks.

A Supervising Ranger is responsible for staff supervision at Portola Redwoods and Castle Rock State Parks. Two full time rangers report to Castle Rock and also provide some services to Portola and Big Basin Redwoods State Parks as needs arise. Maintenance and technical services (water needs) are provided by off-site personnel within the Mountains Sector. Collection of garbage from holding bins is done on an "on call" basis. Equipment maintenance and repair are handled off site.

Castle Rock is primarily a hiking park with two hike-in campgrounds. Park staff relies heavily on volunteers to maintain park trails. Two groups dedicated to trail maintenance have worked monthly at Castle Rock for over 15 years repairing trails and putting in new trails. In 1997, a group of volunteers was organized to assist with trail patrol and to identify problems of human disturbance in the Lion Caves area. They also perform foot patrol in the more heavily used areas of the park.

Occasionally, Department volunteers under the administration of the Volunteers in Parks Program will lead an interpretive program. In addition, there is a group of citizens who have volunteered as an Advisory Committee since the inception of the park in 1968; more recently to advise the District during the General Plan process. A cooperating association, operating under a contract with the Department, raises money for interpretive programs and volunteer projects at Castle Rock and Portola Redwoods State Parks.

Castle Rock State Park is open from 6 a.m. to sunset every day of the year. The greatest use of the park is on weekends in the spring and fall. The park office is located

at the main campground, but because there is no power at the office site, equipment is stored and utilized near the residence at Partridge Farm. Day use and camping fees are generally collected at the Kiosk in the main parking lot, or deposited by visitors at an "iron ranger" located at the parking lot or at the Castle Rock Trail Camp.

Climbing is also a popular sport at Castle Rock State Park. To date, the Department has opted not to regulate climbing; Special Use Permits are required for groups engaged in climbing instruction. In 1996 the advisory committee distributed a guide entitled Castle Rock State Park Rock Climbers. This guide provides rules for voluntary observance by climbers to control resource impacts. The Lion Caves area was recently closed, temporarily, due to damaging rock climbing activity.

Existing Concessions & Agency Agreements

There are no concessions at Castle Rock State Park. The Department has, however, entered into operating agreements with other agencies and districts for the purpose of providing access and recreational opportunities at this state park. The Department also issues special use permits to individuals or groups for a specified use, event, or activity in the park, but are not considered concession contracts.

The type of recreational experience and use of facilities at this state park are primitive in nature. Most visitors bring food, water, and essential equipment used for their specific recreational activity. The average length of stay for day use visitors is 2 to 5 hours. Mobile food units have provided service to park visitors on nearby properties located outside Castle Rock State Park boundaries. These mobile units also serve trail users of the adjacent Sanborn County Park and Midpeninsula Regional Open Space Preserves. Commercial developments provide a multitude of services (such as food, recreation equipment, and information) in cities and communities located within a 10 mile distance (or 30 minutes) from the park.

Agency Coordination

Castle Rock State Park falls within three counties: Santa Cruz, Santa Clara, and San Mateo. Sheriff and California Highway Patrol personnel work with rangers in law enforcement related activities.

The California Department of Forestry and Fire Protection (CDF&FP) is responsible for the park's primary fire protection. A State Parks Wildfire Plan for Castle Rock State Park has been approved by CDF&FP and is on file at the District headquarters. CDF&FP personnel respond to medical emergencies in the park. Partridge Farm is utilized by CDF&FP personnel as a helicopter landing zone for medical evacuations. CDF&FP law enforcement personnel work with state park rangers on law enforcement incidents that deal with timber, such as wood poaching and burl cutting.

The California Department of Fish and Game (CDFG) is concurrently responsible for all wildlife in Castle Rock State Park and works closely with state park personnel in habitat restoration and fish and game law enforcement. CDFG reviews appropriate CEQA documents enforcing their natural resource requirements in state park projects.

The California Department of Transportation (Caltrans) is responsible for the maintenance of State Highway 9, which is partially owned by State Parks (postmile 20.95 to 27.1). Caltrans owns and maintains State Highway 35 bordering Castle Rock State Park. Signing along State Highway 9 is shared by both State Parks and Caltrans, and signing along State Highway 35 is the responsibility of Caltrans. State Parks has an encroachment permit with Caltrans for use of the Caltrans right-of-way along State Highway 35 for trail purposes.

Pacific Gas and Electric Company has a 60 KV power line that passes through the west side of Castle Rock State Park. The Company works with park staff, who monitor their activities, to maintain the right-of-way and repair power lines.

Castle Rock has two water systems that are available to the public and must meet Department of Public Health standards. Water testing is done in accordance with their regulations.

The West Valley College Park Management Program has a long-standing relationship with Castle Rock State Park. Several classes utilize the park for practical training as well as a location to place interns.

Both Santa Clara County Parks and the Midpeninsula Regional Open Space District have property that is adjacent to Castle Rock State Park. There are many issues that our Department has in common with these other agencies, including multiple use of trails and trail connections, fire suppression and management, law enforcement, wildlife management, gun range noise pollution, and administrative concerns.

The San Lorenzo Valley Water District owns a 1,370 acre tract of land on the southern border of the park. The Kings Creek Truck Trail, which is the main fire road that encircles the park on the south and east side, passes through the Water District property ending at the Saratoga Toll Road. Park personnel utilize the truck trail for patrol and administrative purposes. The Water District has an agreement with State Parks to allow use of their property for a portion of the Waterman Gap Trail Camp and the Toll Road to the Skyline-to-the-Sea Interconnector Trail.

The South Skyline Association, Indian Rock Ranch Road Association, and the Las Cumbres Conservation Association are all local landowner groups that affect Castle Rock State Park. A state park trail easement exists through the Indian Rock Ranch subdivision. There are two gun ranges in close proximity to the park: The Los Altos Rod and Gun Club is surrounded by the park and State Highway 35, and the Santa Clara County Peace Officer's Association is located across State Highway 35.

Park Headquarters

The park headquarters is currently situated in an office trailer, located at the Castle Rock Trail Camp. A vacant house built prior to the State's acquisition, and once used as an employee residence, is also part of this early developed administrative area. Overnight use facilities were developed nearby. Potable water is provided from two 20,000 gallon water tanks supplied by water diverted from Craig Springs Creek. A public telephone is available at this location and power has been provided by a portable generator. At the time of initial land acquisition, this area was a desirable location for these facilities. However, in 1998 use of the office trailer is impractical, due to its remote location and the lack of available electricity. As a result, most of the unit administrative and maintenance work is done at Partridge Farm and Tin Can Ranch, or at Big Basin Redwoods and Portola Redwoods State Parks. The house is uninhabitable and is scheduled to be removed. The primary use of this area is now a trail camp for backpackers and an occasional boy scout troop. The backpacker's primitive camping experience is sometimes disturbed by the presence of ranger vehicles and activity at the park office or from the noise of the nearby gun club.

Employee Housing

Two employee residential sites are located in the park, consisting of a house at Tin Can Ranch and two facilities at Partridge Farm (a residence in the historic Partridge house and a concrete pad with hook-ups for an employee trailer a short distance away). The Partridge house and the resident trailer are located on a pre-historic site, and both are serviced by a well and a 10,000 gallon water tank. Electricity is provided by overhead power lines located along State Highway 35. The two houses at Partridge Farm and Tin Can Ranch are located outside the public use areas and were built prior to the establishment of the state park.

Along with the house at Tin Can Ranch, are two other partially completed unoccupied houses and a dormitory, which includes a garage with a second story room located above. This unoccupied dormitory is used for material's storage and serves as a meeting place for staff. The site surrounding the houses was graded and filled, with retaining walls constructed to support building foundations and protect existing trees. The residence is served by a water tank that also serves two private residences on adjacent property to the north. Vehicle access to this area is by a gated dirt road off State Highway 9, 3 miles south of Saratoga Gap.

PLANNING INFLUENCES

SYSTEM-WIDE PLANNING

The Department performs some planning that addresses issues that cross park and regional boundaries. The following are existing statewide or system-wide planning influences that may affect planning decisions at Castle Rock State Park:

- Public Resources Code (PRC)
- California Code of Regulations
- California Environmental Quality Act
- Policies, Rules, Regulations, and Orders of the California State Park and Recreation Commission and California Department of Parks and Recreation
- California Department of Parks and Recreation Operation Manual (DOM)
- California Department of Parks and Recreation Administration Manual (DAM)
- California State Park System Plan
- California State Park Mission Statement
- California State Parks Access to Parks Guidelines
- Resource Management Directives for the California Department of Parks and Recreation. These directives amplify the legal codes contained in the PRC, the California Code of Regulations, and the California State Park and Recreation Commission's Statements of Policy and Rules of Order. The text of the following directives which are particularly pertinent to existing or potential issues at Castle Rock State Park are included as Appendix D:

- #5 State Park Development
- #9 Natural Preserve Integrity
- #26 Consideration of Ecological Factors
- #27 Natural Preserve Establishment
- #28 Visitor Use Impacts
- #29 Vegetation Management
- #34 Exotic Plant Elimination
- #35 Wildlife Habitat
- #36 Wildlife Population Balance
- #37 Erosion Control
- #38 Rock Protection
- #39 Rock Defacement
- #41 Paleontological Resources Protection
- #43 Water Quality Control
- #46 Environmental Quality
- #58 Archaeological Site Protection
- #60 Flow of Human History
- #63 Cultural Resource Management Plan
- #74 Recreation Development/Use

UNIT CLASSIFICATION

Classification establishes broad management guidelines and direction for public use. It provides certain resource protections under the California Public Resources Code (PRC 5019.50), California Parks and Recreation Commission policies, and resource management directives of the Department. An inventory of the unit's scenic, natural, and cultural features was submitted by the Department to the State Parks and Recreation Commission for its consideration prior to classification action (PRC 5002.1).

Castle Rock State Park was classified and named by the State Park and Recreation Commission in 1968. The guidelines presented in this general plan are designed to assist the Department in achieving the goals outlined in the Public Resources Code definition of "state parks".

Public Resource Code that defines "State Park" classification:

PRC 5019.53. State parks consist of relatively spacious areas of outstanding scenic or natural character, oftentimes also containing significant historical, archaeological, ecological, geological, or other such values. The purpose of state parks shall be to preserve outstanding natural, scenic, and cultural values, indigenous aquatic and terrestrial fauna and flora, and the most significant examples of such ecological regions of California as the Sierra Nevada, northeast volcanic, great valley, coastal strip, Klamath-Siskiyou Mountains, southwest mountains and valley, redwoods, foothills and low coastal mountains, and desert and desert mountains.

Each state park shall be managed as a composite whole in order to restore, protect, and maintain its native environmental complexes to the extent compatible with the primary purpose for which the park was established.

Improvements undertaken within state parks shall be for the purpose of making the areas available for public enjoyment and education in a manner consistent with the preservation of natural, scenic, cultural, and ecological values for present and future generations. Improvements may be undertaken to provide for recreational activities including, but not limited to, camping, picnicking, sightseeing, nature study, hiking, and horseback riding, so long as such improvements involve no major modification of lands, forests, or waters. Improvements which do not directly enhance the public's enjoyment of the natural, scenic, cultural, or ecological values of the resource, which are attractions in themselves, or which are otherwise available to the public within a reasonable distance outside the park, shall not be undertaken within state parks.

State parks may be established in either the terrestrial or underwater environments of the state.

(Amended by Stats. 1981, Ch 714, Sec. 363.)

SUBCLASSIFICATION

The Public Resources Code establishes several categories of units that may be included within the boundaries of another unit of the State Park System. These categories include state wilderness, natural preserve, and cultural preserve. The general plan process establishes a mechanism for further determination of values that may warrant inclusion in one or more of these subclassifications. A suitable natural preserve area has been identified and is addressed in *The Plan* section of this General Plan.

Public Resource Code that defines “Natural Preserve” classification:

5019.71. Natural preserves consist of distinct areas of outstanding natural or scientific significance established within the boundaries of other state park system units. The purpose of natural preserves shall be to preserve such features as rare or endangered plant and animal species and their supporting ecosystems, representative examples of plant or animal communities existing in California prior to the impact of civilization, geological features illustrative of geological processes, significant fossil occurrences or geological features of cultural or economic interest, or topographic features illustrative of representative or unique biogeographical patterns. Areas set aside as natural preserves shall be of sufficient size to allow, where possible, the natural dynamics of ecological interaction to continue without interference, and to provide, in all cases, a practicable management unit. Habitat manipulations shall be permitted only in those areas found by scientific analysis to require manipulation to preserve the species or associations, which constitute the basis for the establishment of the natural preserve. (Added by Stats. 1978, Ch. 615.)

ZONE OF PRIMARY INTEREST

The Department’s concern for any environmental changes or ongoing impacts outside the unit that could jeopardize or degrade State Park System values are thought of as zone(s) of primary interest.

At Castle Rock State Park, the Department is concerned about the following: forest management, utility power lines, highway and residential developments that fragment important biocorridors within the unit’s watersheds; the development of radio and telephone antennas on Mt. Bielawski; alignment and width changes for State Highways 9 and 35; water diversions on the San Lorenzo River, Kings Creek, and their tributaries; the potential for water contamination of these streams originating on lands outside of park boundaries; and, ongoing noise pollution from sources originating outside park boundaries (i.e., adjacent gun club, air traffic, and vehicular traffic on State Highways 9 and 35).

This general plan may include discussion about non state-owned properties, their resources values, and the possible effects that some privately managed lands within the same watershed could potentially have upon resources at Castle Rock State Park.

Discussion and all other comments regarding land acquisition are intended for long-range planning purposes only, and do not represent any intent or commitment for acquisition. Acquisition of any land depends on many factors, including the availability of funds and the willingness of the owner to sell. In most areas, through proper enforcement of existing county planning and zoning regulations, private lands can be privately managed in harmony with the neighboring state park lands.



Service Road Trail access and entrance to Gun Club

THE PLANNING PROCESS & PUBLIC PARTICIPATION

This general plan was prepared by a multi-disciplinary team of park professionals from the Department's Santa Cruz District, Santa Cruz Mountains Sector, and the Northern Service Center in Sacramento. Preliminary inventory and evaluation of existing resource conditions and park facilities began in October 1994. The team conducted field reviews, research, interviews, and surveys to compile an information base during the next several months. This work included specific information relating to vegetation, wildlife, esthetics, the area's prehistory and history, surrounding land uses, and visitor use patterns and desires.

A citizen's advisory committee was formed in May 1995, formalizing a prior 1968 group, to advise the Santa Cruz District and assist in gathering and evaluating resource information, and to help promote public participation and cooperation during the general

plan process. The Castle Rock Advisory Committee met almost monthly for three years to discuss park issues and make recommendations to the park management and the planning team. This committee was instrumental in guiding the park's purpose and vision and helping the planning team understand the public interests and concerns for preserving resource values and providing opportunities for appropriate recreational experiences.

Contacts with a number of agencies and other parties outside the Department took place throughout the process, including the California Department of Fish and Game, California Department of Transportation, Pacific Gas & Electric, Midpeninsula Regional Open Space District, Santa Clara County Parks, the San Lorenzo Valley Water District, Sempervirens Fund, Sierra Club, and organized groups interested in rock climbing, mountain biking, horseback riding, astronomy, and representatives from the local Native American community. A visitor survey was conducted during 1996-97 to gather information and help the planning team determine what services, facilities, and programs are needed by and of interest to the visiting public.

Public meetings and planning workshops were held in Los Gatos, Saratoga, and Santa Cruz during three stages in the planning process: (1) Understanding public concerns and planning issues; (2) Presentation and discussion of planning alternatives; and (3) Presentation of the preferred plan. A series of 4 newsletters were mailed to over 500 people and organizations to inform them about the planning process and where to obtain information, provide notice of public meetings and summarize public comments, and explain or clarify the major issues and planning team proposals. Planning information was also made available on the State Park System website via the Internet.

DISCUSSION OF LAND USE ISSUES

This section addresses issues related to potential land uses and the concomitant need for protection of resource values in the park. These issues pertain to access and use of Partridge Farm for public facilities, rock climbing, managing visitor impacts, and provisions for overnight use. It does not, however, summarize or analyze all of the resource management issues that were addressed during this planning process. These issues are addressed by the goals and guidelines of *The Plan* section and discussion of potential impacts in the *Environmental Analysis* section of this document.

PUBLIC ACCESS, DEVELOPMENT, AND USE OF THE PARTRIDGE FARM AREA

The Partridge Farm area has the most potential of any area in the unit to provide organized access for visitors with the awareness of a park management presence. However, concerns were generated for protecting resources in adjacent areas, and therefore, this was the subject of extensive land use discussions.

In considering development at Partridge Farm, there are three primary goals: (1) to provide and manage recreational use in such a way as to minimize resource impacts, (2) to establish a primary contact location to orient visitors to recreational opportunities and educate them about resource values, and (3) to improve manageability of visitor parking.

Partridge Farm has the potential to become a headquarters for visitor services, operations, and recreational support facilities. The site is accessible from State Highway 35, and has available water and power and easy access to trails, scenic overlooks, and popular climbing areas. The old farm house could serve for staff housing, interpretive exhibits, or headquarters for park information and emergency services. Interpretive programs and special events could be enhanced with adequate support facilities, such as parking and restrooms. Staff presence on site would also allow consideration for overnight parking and camping.

The 70-acre Partridge Farm site is located off State Highway 35, two miles southeast of Saratoga Gap and one-half mile north of the main Castle Rock parking lot. The site is currently used for staff housing, maintenance, and administrative functions. Facilities include an old farm house and trailer pad used for staff housing, a temporary office structure, gas pump & shed, water storage tank, reservoir, and an open-air interpretive shelter. Old paved roads and graveled parking remain from its prior use as a Christmas tree farm and are used occasionally for short-term parking during special events. It is also used as a temporary heliport for emergency airlift evacuations. This area also includes evidence of an earlier Native American presence and remnants of historic orchards.

Partridge Farm has had major disturbances since the late 1880's. Forests were first cleared for a fruit orchard before 1900 and then converted to a Christmas tree farm in the 1960's. All native vegetation was removed except for a few oak trees, and roads and parking lots were constructed throughout the tree farm area. In 1984, following the state acquisition of this land, restoration guidelines were developed for the Partridge Farm site which was then referred to as the Boisseranc unit. Attempts to restore this area included removing non-native trees and planting additional oaks. Adjacent to this site are special plants and plant communities, wildlife habitat, and unique geologic features.

The interpretive shelter, constructed with private funds and donated to the park by the Sempervirens Fund in 1985, is located at a trailhead on the southern edge of the farm site. It was intended, originally, to become the primary interpretive center and trailhead for the park. Day use parking was never developed, but the shelter provides interpretive information and shade cover for hikers, and serves as a focal point for occasional special events.

Partridge Farm, with its easy access and open space, currently provides opportunities for occasional special uses, such as outdoor weddings or astronomy gatherings of small groups viewing the stars under the dark skies.

Castle Rock Falls and Goat Rock are among several popular climbing areas located a short distance from Partridge Farm. Other nearby visitor attractions include the scenic overlook and bird observation area. The Lion Caves, an area with moss-covered tafoni sandstone formations, is located one-half mile to the west in the proposed natural preserve.

ROCK CLIMBING AND THE PROTECTION OF SIGNIFICANT RESOURCES

A goal of park management is to provide opportunities for the visiting public to enjoy the park. Another goal is to maintain or restore the qualities of natural features and processes that visitors experience and enjoy. Because recreational pursuits impact these qualities, the challenge becomes one of deciding how much change will be allowed to occur, where, and what actions are needed to manage or mitigate it.

This area designated for climbing encompasses rock features, scenic vistas, and easy trail access, which makes the Castle Rock Ridge one of the more popular destinations for visitors to Castle Rock State Park. The presence of appealing climbing routes, the growing interest in this sport, and the convenient location of this park to the Santa Clara Valley has made rock climbing an integral part of planning and focus for the Castle Rock Ridge area of the park. Rock climbing is one of the traditional uses of the park occurring prior to the State's acquisition, and several types and ability levels of climbing are practiced. The unit issues special event permits for climbing instruction, and notice is given that rock climbing is a "hazardous recreational activity," as defined in

Government Code Section 831.7. Hikers, bird watchers, and others who are attracted here by its natural beauty and opportunities for recreation are also frequent users of this area.

The Department acknowledges these forms of recreation in the park, while at the same time recognizing that resource values must be protected and preserved for the enjoyment of present and future generations. However, impacts from climbing and other forms of recreation, including soil compaction and erosion, moss removal from scraped rock faces, ground vegetation removal, rock face exfoliation, disturbance to wildlife, and bolting of rocks have resulted in a general decline in resource values. This increase in climbing activity in the park has resulted in congested activity areas and has caused users to pursue new climbs deeper into the interior of the park. Unauthorized trails and rock bolting are appearing in areas previously undisturbed.

The Castle Rock Ridge area encompasses approximately 190 acres and is accessible directly from the current main parking lot, Partridge Farm, and Saratoga Gap via the Saratoga Gap and Ridge Trails. It is described as the Castle Rock Ridge Resource Management Zone in Table 1 on page 57, and shown on the Resource Management Zones, Map No. 5.



Rock climber

STATEWIDE CAMPING INTEREST

When planning a unit of the State Park System, opportunities to provide access for users that may come from areas throughout the state are explored. To expand that opportunity at Castle Rock State Park, the Department considered the inclusion of limited overnight facilities for those who may travel a greater distance or want to experience the park's environment during the morning and evening hours. Currently, this opportunity exists only at other state park units, or in primitive backpacking trail camps at two locations in the park.

Castle Rock State Park offers the opportunity to visit a ridge-top environment, which is a portion of the Foothills and Low Coastal Mountains Landscape Province. It provides trailhead opportunities for use of trails at Castle Rock and in the Midpeninsula Regional Open Space Preserves and Bay Area Ridge Trail, and hikes from the ridge to the ocean via the Skyline-to-the-Sea Trail (approximately 30 mile/three day trail hike). Most of the Santa Cruz Mountain region is very accessible to the local communities of the lower peninsula for a bicycle day-trip or visit by automobile any time of the day. The regional trails system also provides primitive trail camps for backpackers. Consequently, it has focused this park unit primarily toward a regional use.

Camping opportunities in the Santa Cruz Mountains and vicinity of Castle Rock State Park exist at Portola Redwoods State Park, 12 miles to the northwest, Big Basin Redwoods State Park, 15 miles to the southwest, and Sanborn-Skyline County Park, 6 miles to the east. These state and county parks provide an overnight experience for conventional car campers in the redwood forest and canyons, and focus the users on recreational activities within those park units. Camping facilities at these other parks include walk-in and family tent campsites, group facilities, and recreation vehicle hook-ups. Overnight visitors to state parks are primarily from major metropolitan areas outside the Santa Cruz Mountains region, and must make reservations for campsites due to the popular demand for these facilities. Campsites in county parks are available on a first-come, first-served basis.

The opportunity to provide for a camping experience within current state park ownership is limited. At Partridge Farm, the physical site characteristics and developed access are favorable for this type of facility. However, it is recognized that resource protection of adjacent areas is a prominent consideration in the use of this property.

Blank page



THE PLAN

Blank back side of divider page

THE PLAN

The purpose of *The Plan* section is to portray the desired resource conditions of the park and desired visitor experience, and to provide goals and guidelines that will direct future management efforts toward achieving those desires. *The Plan* section, however, does not designate detailed facilities with specific size, design, and locations. During the expected life of this general plan, we recognize that new technologies, different recreational needs, and new opportunities cannot be foreseen with the writing of this document. Therefore, different methods can be used in the future to achieve the desired conditions within the parameters provided by this general plan.

The Plan section includes the Declaration of Purpose and Unit Vision, which sets the purpose for park management and the image(s) of what it could ultimately be like in the future. This section includes a discussion of carrying capacity and allowable use intensities designated for specific areas of the park. A further discussion of Resource Management Zones is also provided, including their significant values and constraints, management approaches, and management objectives. Unitwide and area goals and guidelines are prescribed, which state the management intentions and provides general guidance supportive of the park's natural, cultural, scenic, and recreational resources. Collectively, the contents of *The Plan* section will provide the direction for the future management, development, and use of Castle Rock State Park.

UNIT PURPOSE AND VISION

RESOURCE VALUES

Castle Rock State Park has been subjected to repeated logging, farming, road and building construction, and powerline corridor development. The park is still recovering from these past human-caused disturbances that continue to scar the landscape. In addition, it is currently in the flight paths of air traffic to two major metropolitan airports and is affected by gun club noise. However, Castle Rock State Park exhibits "wild" characteristics, evident in its ruggedness and provision of natural habitat for native plants and animals. The protection and perpetuation of this "wild" character of the park are important not only for continued recovery of natural processes, but for the health, inspiration, and enjoyment of visitors.

This Declaration of Purpose for Castle Rock State Park reaffirms the Department's commitment for resource preservation and opportunities for compatible recreation. The potential increase in visitation and future recreation demands will be met with management actions that minimize visitor impacts, with the intent to maintain wildland

values and low-impact recreational use. Castle Rock State Park will remain a wildlands park, providing opportunities for less intensive forms of recreation, solitude, and personal reflection.

Management and interpretation will aim to increase the visitor's understanding and appreciation of resources within the park and surrounding region, and will strive to motivate visitors to help protect and preserve these resources. Significant cultural features will be interpreted and managed for their long-term preservation. Facilities, where necessary for public health, safety, enjoyment, and convenience, will be unobtrusive to minimize impact to the scenic beauty and resource values of the overall area.

The Department will work with other agencies, groups, and private individuals who support these values to identify and protect habitat corridors connecting the park with adjacent "wildlands" * so the natural heritage will continue for generations. Providing access to the park for low-impact recreation is important for the health of the visitor. It provides an opportunity for the public to enjoy the park, experience its values, and gain an appreciation of its significance. This, in turn, will enhance public support for such park values.



Visitors enjoying park trails

* For the purpose of this general plan, "wildlands" is considered an appropriate term to define its quality. Our definition follows:

Wildlands - a large area of land that has functioning natural processes and is occupied by native plant and aquatic communities that support native fauna. It includes areas recovering from prior human-caused disturbances and, therefore, are not necessarily pristine or unaltered.

DECLARATION OF PURPOSE

A declaration of purpose describes the purpose of the park and is the broadest statement of management goals. A declaration of purpose is required by the Public Resources Code, Section 5002.2 (b), "setting forth specific long-range management objectives for the park consistent with the park's classification..." The Declaration of Purpose for Castle Rock State Park will be as follows:

The purpose of Castle Rock State Park is to preserve the outstanding natural resources, wildland values, and supporting ecosystems of the upper watershed of the San Lorenzo River, while providing opportunities for the visiting public to enjoy and be inspired by the unique and diverse topography, geology, biotic communities, and scenic views.

To accomplish this purpose, the California State Park System is to manage the park resources for the continuing scenic, educational, scientific, and recreational benefits of present and future generations. Park management shall guide the recovery of natural processes and features in the park towards the balances that existed prior to the arrival of Euro-Americans. The Natural Preserve will be managed with the goal of achieving wilderness protection. Restoration, preservation, and education of wildland resources and ecological processes will be primary considerations within the Natural Preserve.

UNIT VISION

This unit vision includes guiding images of what the park could ultimately be like in the future. The visionary images are built upon the Spirit of Place and fulfills the Declaration of Purpose. Our vision for the future of Castle Rock State Park is as follows:

Castle Rock State Park is a place of outstanding scenic beauty possessing the vestigial wilderness qualities of the Santa Cruz Mountains, linked through biocorridors with other remnant natural ecosystems of the region. A management philosophy of protecting wildness guides visitors through the scenic vistas, interesting vegetation, and unique landforms.

The park lands and adjacent open space appear as interconnected wildlands recovering from previous human use. The visitor's quest for open space and solitude are met through an integrated system of trails and protected natural areas. Encounters with the most significant park values intensify as visitors penetrate deeper into these forested canyons. An environmental ethic guides responsible behavior and minimizes visitor impacts on the natural systems. There is a heightened awareness of the significance and sensitivity of park resources and the effect recreation may have on the health of the ecosystem, with recognition to preserve this area for future generations.

GENERAL UNIT MANAGEMENT GOALS AND GUIDELINES

This section presents the broad goals and guidelines that are developed for guiding unitwide management of resources, interpretation, visitor use, and development. It addresses all types of related planning issues that are not tied to a geographic area of the park, and specifically covers sub-unit classification.

RESOURCE MANAGEMENT ZONES

The evaluation of natural and cultural features helps decide the resource management approach most appropriate for a given area. In this general plan, these areas are described as Resource Management Zones (RMZs).

Resource management approaches are not land-use designations. Rather, they are philosophies or strategies that steer the development of resource management objectives and guidelines for the defined areas.

Resources in the State Park System are generally managed under one of four approaches briefly discussed below:

Natural Process Management: Nature is recognized as a dynamic system with a complex set of processes and interactions. Under this approach, natural processes are allowed to occur without interference, and where they have been altered or interrupted by human influence, attempts are made to restore processes to a natural condition. Restoration activities will be directed toward self-maintaining levels, if possible.

Cultural Area Management: Preservation and interpretation of significant cultural features are given the highest consideration. This type of management is appropriate in areas of prime historical or archeological significance. Historic zones and historic landscape scenes and settings are managed under this approach.

Recreation Enhancement: Management to enhance visitor appreciation of natural and cultural resources calls for creative resource management approaches. For instance, management of natural vegetation in campgrounds may be based on ecological knowledge, but vegetation would be controlled to enhance visitor safety and facility maintenance.

Special Protection: Giving management priority to a specific element or condition is sometimes required or suggested by legislation earmarking acquisition funding,

by unit classification, by declaration of purpose, as well as by federal, state, and local laws. Archeological site protection, scenic viewshed protection, rare species or rare habitat management, and management for a specific successional stage (e.g., Kruse Rhododendron State Reserve) are all examples of special protection.



Geologic features where moss has been removed for climbing

The RMZs mapped for Castle Rock State Park appear in Map No. 5. They were delineated after an analysis of the natural conditions, cultural features, and current human use patterns for each of the ecological units and cultural resource sensitivity areas (see resource maps, numbers 3 and 4). A brief description and outline of the features and values leading to the appropriate resource management approach for each RMZ is presented in Table 1. Resource management approaches are prioritized in this Table.

The resource management objectives and the guidelines are intended to guide the Department in achieving the broader goals of the State Park System. Some resource management objectives have unitwide or regional significance, while others apply to more specific areas. Objectives and guidelines that have broader application than single RMZs are presented separately under the heading “Unitwide Management Goals and Guidelines.”

TABLE 1. Castle Rock State Park Resource Management Zones: their significant values and constraints, management approaches, and management objectives.

Resource Management Zone and Ecological Unit(s)	Significant Cultural and Natural Values and Constraints	Resource Management Philosophical Approach (prioritized)	Resource Management Objectives
Castle Rock Campground RMZ Upper San Lorenzo River Watershed EU	Knobcone pine community, riparian ecosystem, neobopical migrant songbird habitat, sharp-shinned hawk and loggerhead shrike habitat.	1. Natural Process Management; 2. Recreation Enhancement	<ul style="list-style-type: none"> • Avoid Impacts of campground development on viability of knobcone pine forest and riparian community; • Develop a campground vegetation management plan that allows natural process, utilizes native plants and protects park visitors; • Mimic wildfire processes with prescribed fire management, especially in knobcone pine forest; • Maintain visitor Impacts within acceptable levels related to resource significance; • Prevent/control erosion related to trails and roads.
Castle Rock Ridge RMZ Upper San Lorenzo River Watershed and Upper King's Creek Watershed EUs	Black oak woodland, <i>Ca/andrinla brewer</i> , pallid bat day roost habitat, ringtall and mt. lion habitat, raptor nesting habitat, sandstone outcrops with talon! features, numerous outstanding views of the San Lorenzo River Valley, Monterey Bay and the Pacific Ocean.	1. Natural Process Management; 2. Recreation Enhancement	<ul style="list-style-type: none"> • Protect, preserve, and restore natural ecosystem processes and elements; • Protect special status species and their habitats; • Protect significant cultural resources; • Protect and preserve tafoni formations; • Protect nesting raptors from human disturbance; • Protect springs and seeps; • Access and recreation enhancement provided when compatible with resources; • Maintain visitor Impacts within acceptable levels related to resource significance; • Develop a climbing management plan; • Prevent/control erosion related to trails and roads.
King's Creek RMZ Upper King's Creek Watershed EU	Riparian plant community, neotropical migratory songbird habitat, former steelhead and coho salmon fishery.	Natural Process Management.	<ul style="list-style-type: none"> • Protect, preserve, and restore natural ecosystem processes and elements; • Remove abandoned road along McDonald Gulch and restore proper form to watershed; • Maintain visitor Impacts within acceptable levels related to resource significance.
King's Creek Canyon RMZ Upper King's Creek Watershed EU	Ancient redwood forest, riparian ecosystem, marbled murrelet habitat, ringtall habitat, mt. lion, sharp-shinned hawk & Cooper hawk foraging and potential nesting habitat, peregrine falcon roosting habitat, migrant songbird habitat, sandstone outcrops and cliffs with talent features, springs and seeps, active seismic area prone to ground rupture, active and dormant landslides, steep slopes and erosive soils, burlled shingle mill, historic road, Interior views of cliffs, forest and streams, excellent distant views of King's Creek drainage.	1. Special Protection; 2. Natural Process Management; 3. Cultural Area Management.	<ul style="list-style-type: none"> • Protect, preserve, and restore natural ecosystem processes and elements; • Inventory and monitor ancient redwood stand and related special status species; • Protect talon! formations and moss-covered cliffs and rock outcrops; • Provide for controlled foot traffic; • Protect springs, seeps and riparian communities; • Eradicate exotic plants; • Maintain visitor Impacts within acceptable levels related to resource significance; • Control/eradicate feral pigs; • Prevent/control erosion related to trails and roads.
Lion Caves RMZ Upper San Lorenzo River Watershed EU	Knobcone pine forest and black oak woodland communities, potential pallid bat day-roost habitat, loggerhead shrike, ml. lion and ringtall habitats, sandstone outcroppings with near-pristine talon! features; seismically active area, Interior views of shady, wooded canyon with large, moss-draped outcrops.	1. Special Protection; 2. Natural Processes Management.	<ul style="list-style-type: none"> • Protect sandstone outcroppings, boulders, talon] formations and attached vegetation; • Preserve, protect and restore natural ecosystem processes and elements; • Protect special status species and their habitats; • Protect springs, seeps, and creeks; • Maintain visitor Impacts within acceptable levels related to resource significance; • Provide for controlled foot traffic; • PrevenUcontrol erosion related to trails.
Mt. Blelawski RMZ Upper King's Creek Watershed EU	Historic orchard, excellent views of the King's Creek Canyon, the Santa Cruz Mountains and the Pacific Ocean.	1. Cultural Area Management (of orchard); 2. Natural Process Management in areas outside of orchard.	<ul style="list-style-type: none"> • Maintain historic orchard; • Protect, preserve and restore natural ecosystem processes and elements; • Maintain visitor Impacts within acceptable levels related to resource significance; • Prevent/control erosion related to trails and roads.
Partridge Farm RMZ Upper San Lorenzo River Watershed EU	Cooper's hawk and pallid bat habitat, historic farmhouse, archaeological site, historic orchard, interior views of mixed evergreen forest and oak woodland.	1. Recreation enhancement; 2. Historic Area Management of historic orchard; 3. Natural Process Management of zone outside of developed areas.	<ul style="list-style-type: none"> • Access and recreation enhancement where compatible with resources; • Maintain historic farmhouse; • Maintain historic orchard; • Protect, preserve and restore natural ecosystem processes and elements In areas outside of facility developments; allow limited modification of natural processes within areas of facilities development; • Protect special status species and their habitat; • Maintain visitor Impacts within acceptable levels related to resource significance; • Prevent/control erosion related to trails and roads.

<p>Saratoga Gap RMZ Upper San Lorenzo River Watershed and Pescadero Creek Watershed EUs</p>	<p>Potential <i>Clarkia concinna</i> ssp. <i>automixa</i> habitat, Interior views of mixed evergreen forest, distant views of Santa Clara Valley, the Santa Cruz Mountains, and the Pacific Ocean.</p>	<p>1. Recreation Enhancement; 2. Natural Process Management.</p>	<ul style="list-style-type: none"> • Access and recreation enhancement where compatible with resources; • Protect steep slopes and erosive soils, and evaluate old logging roads for removal & revegetation; • Protect significant cultural resources; • Protect, preserve, and restore ecosystem processes and elements in areas outside of developed zone; • Protect special status species and their habitats; • Maintain visitor Impacts within acceptable levels related to resource significance; • Prevent/control erosion related to trails and roads.
<p>Saratoga Toll Road RMZ Upper San Lorenzo River Watershed EU</p>	<p>Remnant isolated ancient redwood trees and large, late-phase second growth redwood, historic toll road alignment, historic tavern/rest stop site, excellent interior views of mixed evergreen forest, annual grassland and redwood forest.</p>	<p>1. Recreation Enhancement (Toll Road and trails); 2. Natural Process Management; 3. Historic Area Management of Toll Road alignment and historic tavern site.</p>	<ul style="list-style-type: none"> • Access and recreation enhancement where compatible with resources; • Protect steep slopes and erosive soils; • Protect significant cultural features; • Protect, preserve, and restore natural ecosystem processes and elements in areas outside of developed zone; • Protect special status species and their habitats; • Prevent/control erosion related to trails and roads; • Exotic species removal; • Maintain visitor Impacts within acceptable levels related to resource significance.
<p>San Lorenzo River RMZ Upper San Lorenzo River Watershed EU</p>	<p>Riparian ecosystem, steelhead spawning habitat, California red-legged frog habitat, western pond turtle habitat, potential yellow-legged frog habitat, neotropical migratory songbird habitat, natural springs & seeps, Interior views of river canyon and second growth redwood forest.</p>	<p>1. Special protection; 2. Natural Process Management.</p>	<ul style="list-style-type: none"> • Protect, preserve, and, where necessary, restore stream ecosystem processes; • Protect special status species and their habitats; where appropriate, restore anadromous fishery; • Preserve and protect riparian and aquatic communities; • Protect water quality; • Evaluate ponds on Tin Can Creek and on unnamed creek near Partridge Farm for possible removal; • Protect springs and seeps; • Maintain visitor Impacts within acceptable levels related to resource significance; • Prevent/control erosion related to trails and roads.
<p>Skyline RMZ Stephen's Creek Watershed and Saratoga Creek Watershed EUs</p>	<p>Distant views of Santa Clara Valley and Interior coast range.</p>	<p>1. Natural Process Management; 2. Recreation Enhancement.</p>	<ul style="list-style-type: none"> • Protect, preserve, and restore natural ecosystem processes and elements; • Access and recreation where compatible with resources; • Exotic species removal; • Prevent/control erosion related to trails and roads; • Maintain visitor Impacts within acceptable levels related to resource significance.
<p>Tin Can Ranch RMZ Upper San Lorenzo River Watershed EU</p>	<p>None</p>	<p>1. Recreation Enhancement; 2. Natural Process Management.</p>	<ul style="list-style-type: none"> • Access and recreation where compatible with resources; • Protect, preserve, and restore natural ecosystem processes and elements in undeveloped areas of zone; • Maintain visitor Impacts within acceptable levels related to resource significance; • Prevent/control erosion related to trails and roads.
<p>Travertine Springs RMZ Upper San Lorenzo River Watershed EU</p>	<p>Riparian ecosystem. Raptor foraging habitat, freshwater springs and seep, travertine formations, hydric soils.</p>	<p>Natural Process Management.</p>	<ul style="list-style-type: none"> • Protect and preserve natural ecosystem processes and elements; • Protect springs and seeps; • Protect hydric soils; • Maintain visitor Impacts within acceptable levels related to resource significance; • Prevent/control erosion related to trails and roads.
<p>Wildlands RMZ Upper San Lorenzo River Watershed, Pescadero Creek Watershed, Upper King's Creek Watershed, and Deer Creek Watershed EUs</p>	<p>Raptor foraging habitat, mt. lion, ringtail, marbled murrelet, Vaux's swift, pallid bat, Townsend's big-eared bat, unspotted fritillary butterfly, sharp-shinned hawk and Cooper's hawk habitats, natural springs and seeps, steep slopes with erosive soils, sandstone outcrops with talon) features, seismically active, prone to ground rupture, distant views of Monterey Bay and Pacific Ocean, Interior forest and stream views.</p>	<p>1. Natural Process Management; 2. Historic Area Management of historic roads.</p>	<ul style="list-style-type: none"> • Protect, preserve, and restore natural ecosystem processes and elements; • Special protection for special status species; • Special protection for tafoni formations; • Protect seeps and springs; • Protect and preserve historic road alignments; • Prevent/control erosion related to trails and roads; • Exotic species removal; • Control/eradicate feral pigs; • Maintain visitor Impacts within acceptable levels related to resource significance.

TABLE 1 (continued). Castle Rock State Park Resource Management Zones: their significant values and constraints, management approaches, and management objectives.

UNITWIDE RESOURCE MANAGEMENT GOALS & GUIDELINES

Presented below are general goals and guidelines that are unitwide in their application:

Resource management program development and implementation is contingent upon the availability of funding. The Department should continue efforts to secure funding necessary for the success of this and other unitwide management programs.

NATURAL RESOURCES

A comprehensive resource management program should be established for the management of natural processes and elements at Castle Rock State Park. This program should address watershed, vegetation, and wildlife management issues, including subcategories such as soil erosion management, landform restoration, fisheries management, and prescribed fire management.

Watershed Management

Modern-day land uses such as logging, road building, rural residential development, and trail construction have altered the natural processes of the San Lorenzo River Watershed within Castle Rock State Park. The greatest problem resulting from these uses is stream sedimentation. Stream flows do not have the ability to carry unnaturally large sediment loads downstream. The channel becomes clogged, thereby raising the level of the stream bed and increasing the risk of flooding locally and downstream. Aquatic habitat is also altered, impacting the river's biota.

Goal: Restore upper watershed function and remedy unnatural soil erosion and stream sedimentation problems within Castle Rock State Park.

Guidelines:

- The Department should cooperate with other landowners and regulatory agencies to address watershed issues affecting Castle Rock State Park.
- The Department will develop a Watershed Management Program to remedy unnatural soil erosion and stream sedimentation problems within Castle Rock State Park.

Vegetation Management

Plant communities at Castle Rock State Park have been impacted since the mid-19th Century by logging, residential and agricultural development, and alteration of the fire regime. These impacts have caused a shift in species composition, changes in the structure of plant communities, and a change in the pattern of communities at a landscape level. In particular, fire suppression activities are contributing to the decline of many native plant communities and increasing the possibility of a wildfire due to excessive fuel loads.

Goal: Preserve and perpetuate examples of natural plant communities, and restore, protect, and maintain native ecosystems and indigenous flora and fauna.

Guidelines:

- The primary objective is to manage vegetation toward a natural condition with a minimum of disruption to natural processes. A secondary objective is to perpetuate and restore the composition and structure of native plant communities that would prevail in the absence of human influences, including fire suppression.

Wetland and Meadow Soil Constraints

Human, animal, and wheel traffic damages wetland soils by destroying vegetation and compacting it into a sodden mass that resists revegetation when dry. When wetland soils lose vegetative cover and dry, they are highly sensitive to wind erosion. These soils occur at springs and seeps located throughout the park unit.

Goal: Prevent wetland soils compaction and destruction of associated vegetation.

Guidelines:

- Trails through areas with wetland soils should be designed and constructed to allow access over, but not on, fragile wetland soils. Where this is not feasible, trails should be rerouted to avoid such soils.

Special Plants and Communities

Special plants are listed annually on the California Department of Fish and Game's Special Plant List. A subset of this list includes those species listed by the U.S. Fish and Wildlife Service, the California Department of Fish and Game, and the California Native Plant Society (CNPS) as rare, threatened, or endangered. Species that are proposed for listing by the federal and state governments are legally protected as if they

were listed, and species listed by CNPS on their lists 1A and 1B meet the criteria for listing and are protected as such. Other species locally sensitive and important to the management of park units are also considered special by the Department. Special plants can be inadvertently destroyed by facility development, maintenance programs, visitor use, or other activities, especially when the exact population locations, habitat requirements, and tolerances are not known.

Special plant communities include those either determined to be rare by the California Department of Fish and Game Natural Diversity Data Base (i.e., knobcone pine forest and white alder riparian forest), are of local significance (i.e., California black oak woodland), or provides critical habitat for State and/or Federal listed wildlife species (ancient redwood forest).

Goal: Protect special plants and special plant communities within Castle Rock State Park and manage for their perpetuation in accordance with state law (PRC, Division 2, Chapter 10, Section 1900).

Guidelines:

- Prior to any site-specific development, heavy use activities, or prescribed burns, additional surveys should be made, which contain quantitative baseline information for long term monitoring of special plants. These surveys should be done during the appropriate flowering seasons in the areas that will be impacted. Populations of all special plant species found within the unit should be mapped.
- Because of their limited distribution in the Santa Cruz Mountains or on a statewide basis, ancient redwood forest, knobcone pine forest, white alder riparian forest and California black oak woodlands occurring at Castle Rock State Park shall be considered as Special Plant Communities and their preservation should be a high priority in vegetation management.

Exotic Plants & Landscaping Plant Materials

Exotic plant species are of concern in numerous locations at Castle Rock State Park. Exotic species detract from the natural appearance of the unit, can escape into the wild, and can displace native species.

Goal: Prevent the establishment and spreading of exotic plant species in the park.

Guidelines:

- A long-term program of control and/or eradication measures is necessary to prevent the establishment and spread of non-native species that could displace

native species and disrupt natural communities. Priority for control efforts should be given to those species most invasive and conspicuous in the park.

- Landscaping in developed areas should consist of species indigenous to the area and of local genetic stock. Exotic species used for interpretive reasons shall be species incapable of naturalizing and spreading into other areas of the unit and species not requiring a permanent irrigation system, with exception for areas adjacent to employee housing. Natural vegetation in campgrounds and other high visitor use areas should be managed to mimic native vegetation patterns consistent with safety and esthetic objectives, and State Park System values.

Prescribed Fire

Plant communities in the park and adjacent lands have evolved with fire, both natural and human-caused. A policy of fire exclusion by state and federal agencies during this century has altered the fire regime and created significant changes in the species composition and stand structure of the native communities. This is especially true of knobcone pine and oak woodland communities, which are fire-maintained vegetation types. Fire exclusion has favored more shade tolerant species and communities, decreasing the diversity of vegetation and wildlife habitat in the park and increasing fuel buildup. These changes dramatically increase the possibility of wildfire on park lands.

Prescribed fire is a tool that allows land managers to mimic conditions that existed prior to Euro-American settlement. Fire has affected the evolution of individual species and the pattern of vegetation across the landscape.

Goal: Reinstigate the benefits of fire to restore species composition and stand structure of native plant communities.

Guidelines:

- The use of prescribed fire shall be considered for ecosystem management in the park. If prescribed fire is deemed necessary, a unitwide Prescribed Fire Management Program should be established.

Wildfire Suppression and Prevention

Wildfire can be a threat to human life and property and can also severely damage State Park System resources. Because conventional fire control methods, equipment, and procedures often cause longer lasting damage to resources than does fire itself, the development of standards and procedures applicable to this park is necessary.

Goal: Protect Castle Rock State Park resources from unnecessary damage from wildfires and their suppression.

Guidelines:

- The unit's Wildfire Management Plan that addresses wildfire prevention, presuppression, and suppression should be periodically updated and reviewed by the Department in cooperation with the responsible fire control agencies. This plan should be consistent with the primary unit resource values and management objectives. Suppression methods shall cause the least resource damage commensurate with effective control. Department standards require a minimum disturbance of soil and primary emphasis on avoiding adverse aesthetic impacts in the location, construction, and maintenance of fire roads and fuelbreaks.

Wildlife Management

The protection and perpetuation of native wildlife populations will be accomplished, in part, through the restoration and enhancement of native plant communities and the removal of exotic plant taxa within the context of a Vegetation Management Plan. The following goal and guidelines further define the vision for wildlife management at Castle Rock State Park.

Goal: Protect and perpetuate native wildlife populations at the park.

Guidelines:

- The Department will protect and preserve native wildlife populations and avoid ecological imbalances that result from human-caused activities. Specific management programs should be developed as necessary to protect and restore sensitive animal populations and their habitats using sound ecological principles and professionally accepted methods. If it is necessary to regulate animal populations, the methods used will be based on sound principles of ecosystem management, will be consistent with Department Resource Management Directives, and will avoid disturbance to other natural values of the park.
- Park-wide surveys on sensitive species should be conducted to document and map their presence within, movements through, and uses of the park. Studies should be conducted to determine the current presence or absence of amphibian species previously documented to occur in Castle Rock State Park in order to update the unit data file.
- Prior to any site development, heavy use activity, or prescribed burn, surveys for sensitive wildlife will be conducted during the appropriate season for detection in areas that will be affected. Programs or projects to be undertaken should be

designed and scheduled so that sensitive wildlife and their requisite habitat will not be adversely affected.

- The Department will work with surrounding property owners and jurisdictions to reduce the numbers of non-native animals such as feral pigs, feral cats, cowbirds, bullfrogs and starlings that enter the park.

Biocorridors

Protecting biocorridors and facilitating the continued movement of plants and animals within Castle Rock State Park, and between the park and other wildland areas, is imperative to maintaining the health of the ecosystem and regional conservation.

Goal: Maintain and enhance the movement of plants and animals within the park, and between the park and other wildland areas whenever possible.

Guidelines:

- Biocorridors should be designated when there is enough information to indicate the importance of these connections to the exchange of plants and animals between Castle Rock State Park and other wildland areas. The adequacy and effectiveness of these corridors should be monitored by documentation of the presence, distribution, movement, and habitat associations of the representative species using them.
- The collection of baseline information and the monitoring of the health and function of core areas and biocorridors should be included in the park's resource management program. The effects of human uses on the integrity of the system should be measured.
- The Department, along with federal, state and local jurisdictions and councils, transportation agencies, regulatory agencies, and private landowners, should work together to insure that preserves and interconnecting biocorridors are effectively managed at a regional level.

Zone of Primary Interest

Human-caused disturbances on properties adjacent to Castle Rock State Park can have detrimental effects on park resources and disrupt natural ecosystem processes. Soils in this area are erodible and often occur on moderate to steep slopes. Activities including logging, residential or commercial development, land clearing, and road building can result in increased sedimentation of park streams. The areas of most concern are the Indian Rock Ranch Subdivision and the San Lorenzo Valley Water District property

(Waterman Gap unit). Some of these lands are upslope of the park, and drain into the San Lorenzo River and Kings Creek.

Goal: Mitigate or prevent outside disturbances from having adverse impacts on park resources and disruption of natural ecosystem processes.

Guidelines:

- The Department should continue to work with local jurisdictions and appropriate organizations, and adjacent property owners to ensure long-term protection of park resources and the ecosystems of the Santa Cruz Mountains. The Department should review and comment on all projects proposed on lands adjacent to the park to determine if they could have a detrimental effect on park lands.

Seismicity & Landslides

Castle Rock State Park lies within an area of high seismic activity. The park is located about 1.5 miles west of the San Andreas fault and 12 miles east of the San Gregorio fault. Both of these faults are considered active. The San Andreas fault is capable of generating an earthquake with a magnitude of 8.5 on the Richter scale. Continued seismicity, ground rupture, and violent shaking are to be expected. The San Gregorio Fault is capable of generating an earthquake of magnitude 7.2 to 7.9 on the Richter scale (up to 8.5 on the Richter scale if significant vertical movement occurs).

Large, relatively old landslides and a number of localized active slope failures are evident throughout the upper and mid-slope areas of the unit and along various road cuts. They indicate that the park has a high potential for landslides. Generally, new facilities should not be constructed on, or in the path of landslides, or in areas recognized as having a high potential for slope failure.

Goal: Provide for public safety and prevent structural failures due to seismic activity and landslides through proper siting and design of future park facilities.

Guidelines:

- The siting and design of permanent structures and major development projects should include professional geological evaluations, site investigations, and soil testing. This should be prepared early in the project planning process in order to evaluate the geologic conditions and determine the appropriate facility design, including drainage control.

Geologic Features: Tafoni, Fossil Resources, and Associated Values

Castle Rock State Park is a popular destination for visitors because of its unique geologic resources. Several sandstone outcrops of the Vaqueros and Butano Formations in the park exhibit rare “tafoni” features. These differentially weathered features, including caves, spheroidal masses referred to as “cannonballs,” and lattice-like structures on rock faces and walls termed “fretworks,” are often very fragile and can be easily damaged.

Rock climbing on sandstone outcrops and boulders has become a popular form of recreation in the park. However, impacts from this sport on rock features and associated elements have resulted in a general decline in resource values. Impacts include rock face exfoliation and tafone disturbance, moss removal from scraped rock faces, soil compaction and erosion, ground vegetation removal, and disturbance to wildlife. The Department acknowledges low impact climbing as a valid form of recreation in the park, while at the same time recognizing that resource values must be protected and preserved for the enjoyment of present and future generations.

Goal: Protect and preserve tafoni features, including caves, spheroid masses called “cannonballs”, and lattice-work rock walls and faces. The fossil and mineral record and specimens of Castle Rock State Park will also be preserved.

Guidelines:

- Geological investigations will be performed on sandstone outcrops where significant tafoni features are present in order to recommend and implement appropriate measures for their preservation.
- Scientific investigation and analysis by various universities and museums should be encouraged to broaden the knowledge of park resources. Private collection and willful disturbance or dislodgment of the geological forms shall not be allowed.
- In order to protect natural resource values, only low-impact recreational climbing (defined below) will be allowed. A climbing management plan should be developed that protects natural and cultural features, especially tafoni, and includes mitigation for impacts resulting from climbing.

For purposes of this plan, low-impact rock climbing is defined as that form of rock climbing that does not destroy or place into jeopardy of destruction the unique tafoni features inherent in many rock outcrops. Low-impact climbing considers the use of climbing equipment, including the appropriateness and possible use of bolts, and prohibits the deliberate destruction of lichen, vegetation, soils, rock

surfaces, and/or rock art, including pictographs and petroglyphs, and prehistoric rock shelter sites.

CULTURAL RESOURCES

Prehistoric Sites

There is a significant cluster of six prehistoric sites in the Partridge Farm area. These sites represent a seasonal camp of undetermined age. No other prehistoric sites have yet been discovered within the boundaries of Castle Rock State Park. There is a possibility that significant rock art sites may exist in the large rock formations within the park. In general, prehistoric resources are scarce in the park and therefore all are potentially significant.

Goal: Identify and protect all significant prehistoric sites in Castle Rock State Park.

Guidelines:

- Measures will be taken to identify and protect all significant prehistoric sites from adverse effects resulting from park use, development, resource management programs or natural processes such as erosion. Future uses and activities will be designed to avoid impacts to significant prehistoric resources to the maximum extent feasible.

Historic Resources

Few obvious historic features remain from activities prior to the park's acquisition in the 1960s. The Partridge house, built in 1924, old cabin sites, historic toll road, and remnants of historic orchards were located in the park and recorded. Guidelines for preservation of the Partridge house and historic orchards are provided in the Area Goals and Guidelines Section. In addition, old logging roads and skid trails riddle the Castle Rock area. Inventory and mapping of these roads could provide important information about the locations of potentially significant logging sites.

Goal: Identify and protect all significant historic sites and features in Castle Rock State Park.

Guidelines:

- Measures will be taken to identify and protect all significant historic sites and features. Historic resources will be preserved and protected through implementation of Department and professional standards.

- The alignment of old logging roads should be inventoried and mapped prior to their removal or restoration to natural conditions.

ESTHETIC RESOURCES

Scenic Preservation

The diverse landscape of this region offers visitors a variety of scenic experiences, from expansive views of the Santa Cruz Mountains and Central California coastline to intimate views of wooded canyons and secluded grasslands with native wildflowers. The viewsheds from Skyline Boulevard and State Highway 9 are highly valued. Inappropriate facilities, utilities, and signage can significantly degrade these visual resources.

Goal: Protect the scenic resources inherent to the vicinity of Castle Rock State Park from potentially degrading intrusions.

Guidelines:

- Park facilities should visually integrate into the environment through the use of appropriate siting techniques, scale, materials, and colors. The Department should work with adjoining jurisdictions regarding land use and development within the viewshed of the unit that may affect the park and its scenic resources.

Abandoned and Unsightly Debris

Previous property owners of some land parcels now included in Castle Rock State Park have left behind debris that is unsightly and poses an environmental risk. This debris includes numerous tires in the Mt. Bielawski area, abandoned vehicles in the Sempervirens Point area, and concrete culverts along the old Hansen Road leading to Craig Springs Creek. Abandoned tires provide breeding habitat for mosquitoes and are a significant wildfire risk. While toxic fluids have been removed from abandoned vehicles, their presence in the park is unsightly and not in conformance with esthetic values. Similarly, concrete culverts dumped along the Hansen road do not blend in with the natural environment.

Goal: Eliminate unsightly debris and elements that pose an environmental risk to people and resources at Castle Rock State Park.

Guidelines:

- The Department should remove abandoned tires, vehicles, and concrete culverts from the park.

Noise Reduction

Castle Rock State Park is adjacent to two State Highways and a gun club, and is within the flight path of San Francisco and San Jose International Airports. As such, the park receives intrusive noise pollution that serves as an annoyance to the visiting public.

Goal: Reduce the impact of noise pollution in the park.

Guidelines:

- The Department will work with the appropriate agencies and private property owners that regulate or generate noise pollution affecting Castle Rock State Park in efforts to reduce this pollution to levels that are non-intrusive.

Utility Easements

Overhead utility lines and their easement corridors constitute visual intrusions that are incompatible with the otherwise natural appearance of the unit. Maintenance of powerline corridors impacts the species composition and vegetative structure of plant communities, indirectly affecting wildlife. Vehicles accessing these rights-of-way impact wet soils, vegetation, and other natural features.

Goal: Work to bring about the elimination of the existing high power transmission lines, along with associated rights-of-way through the unit, and to restore the area to natural conditions.

Guidelines:

- Where possible, power lines serving the park should be placed underground. The Department should work with utility companies to determine the most appropriate access and methods of powerline maintenance that have the fewest impacts to park resource elements and values. Ultimately, high power transmission utilities and their associated rights-of-way should be removed and the natural landform and vegetative cover restored.

UNITWIDE VISITOR USE & OPPORTUNITIES

CARRYING CAPACITY

Public Resources Code Sections 5001.96 and 5019.5 state that the land carrying capacity shall be determined before any park development plan is made, and that

attendance at State Park System units shall be held within the limits established by this capacity. A definition of carrying capacity by the code, however, is not provided.

The carrying capacity of land is understood here to mean a land's inherent ability to sustain over time both the integrity of its natural systems and the land uses dependent upon them. It implies that there is a point in any system after which the ability to regenerate is exceeded by demands on the system, and a cumulative net loss results. In terms of park and recreation planning, carrying capacity may be extended in meaning to suggest that no cumulative net losses occur in any of the resource values of a unit (natural, cultural, aesthetic, or recreational) due to human use (activities or facility development). Many seemingly insignificant effects tend to be permanent and cumulative, and the legislative intent (in the Public Resources Code) is to avoid long-term degradation of a resource-based park system. The difficulty arises in establishing such a capacity and quantifying it in terms of attendance limits. Significant resource damage can occur instantly by one individual or by many people over a long period of time. Different types and patterns of recreational use may also contribute toward resource and social impacts. These impacts can be reduced or avoided by taking management actions and initiating proper mitigation measures. Capacity limits, use regulations and enforcement, education and interpretation, site investigations and monitoring, planning and proper design, and staff presence all contribute in minimizing the impacts visitors have on park values. The first step of guiding future public access or use of a park is to determine the location and significance of the unit's resource values.

The following presents an overview of the resource sensitivities, physical constraints, and intended park use, through descriptions of the park areas in three categories of allowable use intensity.

ALLOWABLE USE INTENSITY

Allowable use intensity correlates the significance, sensitivities, and constraints of the unit's resources with an allowable degree of disturbance due to human impacts. These uses may be defined by human activities and/or development of facilities. Allowable use intensity designations consider past, present, and future uses, and are used as planning tools in assessing the appropriateness of future proposals. The Allowable Use Intensity Map (Figure 2) illustrates which areas are included in each allowable use category.

Low Allowable Use Intensity - Category I

In Category I areas determined to have a low allowable use intensity, important resource values are especially vulnerable to impacts from activities and development. This category encompasses significant geologic features in pristine and near-pristine conditions and areas with high ecological sensitivities such as rare and endangered

flora, rare natural communities, threatened and endangered wildlife and aquatic life, and important habitats for these species. Category I includes those areas that are moderate to severely constrained by soil and hydric conditions, and/or geologic hazards. Any allowable uses must be subordinate to the integrity of these resource values. Restoration or enhancement of resources shall be undertaken in situations where past or current uses have undermined them. For the most part, no facility development shall be allowed in these areas, with the exception of appropriate trail development. Well-designed trails serve an important role in ultimate protection and appreciation of resource values. Sight-seeing, hiking, and nature study are representative of appropriate activities for this category.

Moderate Allowable Use Intensity - Category II

Moderate allowable use intensity in category II areas include those moderate to severely constrained by soil conditions such as slope and erosion conditions when exposed; hydric conditions such as seasonal flooding, 100-year floods, and/or geologic hazards such as fault zones. Ecologically sensitive areas in this category are those with native plant communities that help define the character of the unit, and that provide habitat for native wildlife, and spot locations of sensitive flora and fauna. Moderately sensitive cultural resources such as historic features of undetermined importance are included in this category also.

Appropriate facilities in the moderate use intensity category include such uses as trails, roads, primitive trail camps, small structures for interpretation and rest stops, and low impact rock climbing outside the natural preserve and where appropriate as determined through a climbing management plan. Provision for such uses will be designed to avoid or minimize impacts on natural and cultural resources. All other uses and activities compatible with Category I areas are appropriate here.

High Allowable Use Intensity - Category III

Lands of higher allowable use intensity in Category III are not, or are only slightly, constrained by soil conditions, hydric conditions, or geologic hazards, although seismic activity and severity are difficult to predict. In this category are areas with less ecological sensitivities but that still contribute to the general character and appeal of the unit, such that larger scale disturbance in these areas would appreciably diminish the attractiveness and ambiance of the unit as a whole. Cultural resource sites and features with known slight sensitivities are included, as long as no major resource modifications are undertaken. Appropriate facilities in this high use intensity category are trails, roads, buildings and other facilities designed to blend esthetically with scenic, natural, and cultural features, and to avoid large-scale disturbance and minimize impacts. Parking availability, group activities, walk-in camping, administrative and

maintenance functions, and all other compatible uses identified with Category I and II areas are appropriate in Category III.

Allowable Use Intensity Map Application

Not all areas in a category share the same characteristics or are affected in the same way by the conditions that may influence them. Therefore, the Allowable Use Intensity Map is useful only for general planning purposes. When site-specific proposals for land uses or facilities are to be prepared, the proposed location will be checked for resource constraints and sensitivities on various resource maps on file with the District, during the preliminary planning phases of the project. Site-specific investigations may also be necessary.

MANAGING RESOURCES AND VISITOR IMPACTS

It is recognized that any recreational use produces at least some impact, and that the Department needs to manage visitor impacts. Also recognized is the importance of providing and maintaining diversity in resource features and conditions of the park.

Goal: Apply processes and methods of visitor impact analysis to minimize resource impacts and maintain appropriate types and levels of visitor use within this unit.

Guidelines:

- In accordance with the California Environmental Quality Act (CEQA), prior to site specific development or preparation of management plans, the area of potential impact will be surveyed and reviewed by appropriate personnel and responsible agencies. Resource conditions will be periodically assessed and appropriate actions taken to maintain acceptable conditions and manage use accordingly.

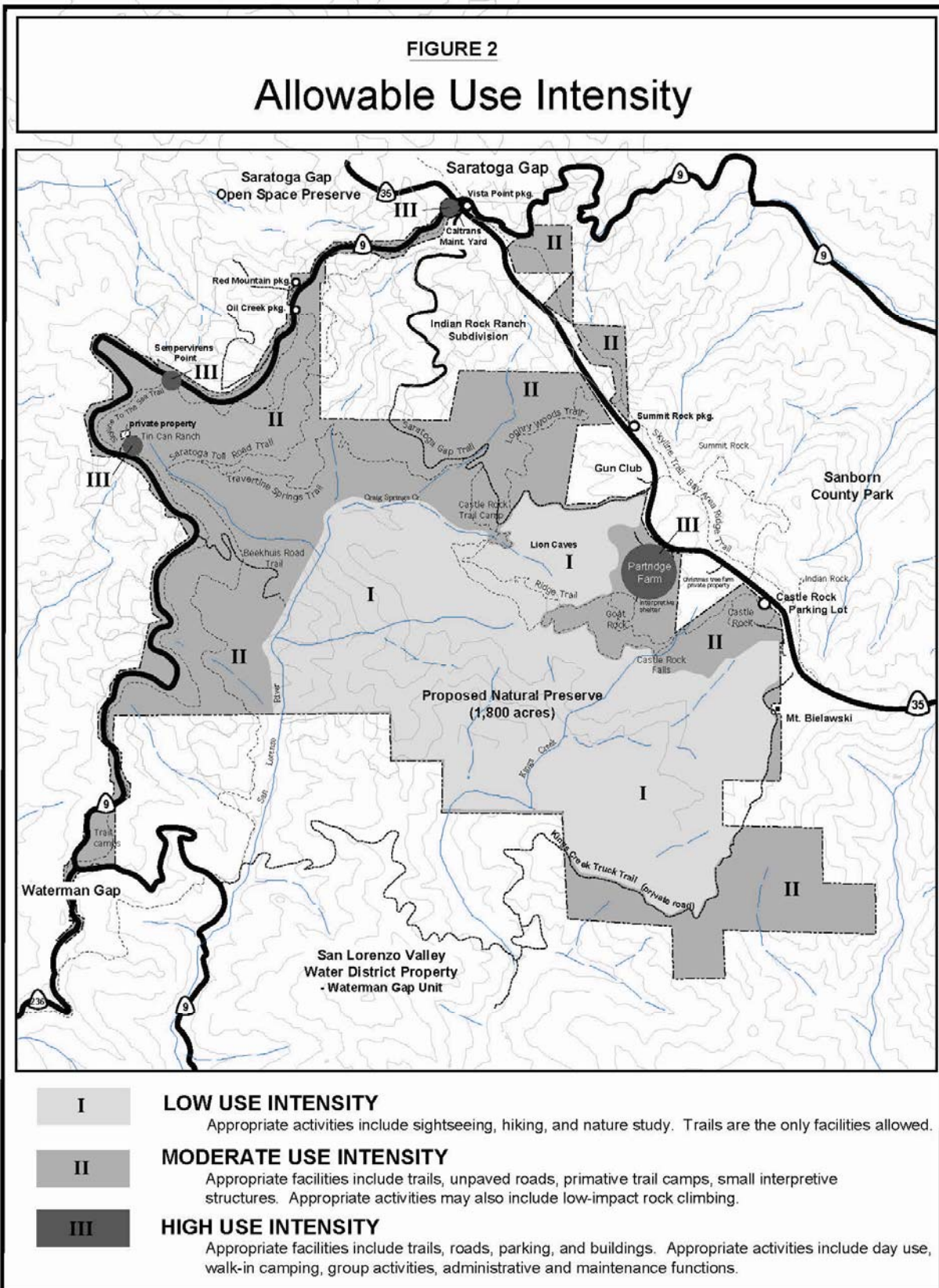

UNITWIDE ACCESS AND TRAILS

Castle Rock State Park has multiple access points located at the various roadside parking areas, or trailheads designated at the park's perimeter. The intensity of use on trails varies with the destination of visitors and their purpose for long or shorter hikes, or for access to park features and climbing areas. Trails and open space corridors provide vital connections between public open space and recreation areas in the Santa Cruz Mountains.

The existing trail system is the primary recreation facility and means for visitors to experience undeveloped areas of the park. Unless well planned and maintained, they also may constitute a significant environmental impact. Impacts resulting from existing trail use at Castle Rock State Park include the propensity of numerous "social trails," vegetation damage, and soil erosion that alters drainage patterns and increases sediments to streams. Increased sediments impact aquatic resources and contribute to flooding. In addition, trails may direct visitors to areas with sensitive cultural resources, or plant and/or wildlife populations that require special protection.

With one exception, trails at Castle Rock are currently closed to mountain bike use. The Castle Rock campground is accessible by bicycle via the Service Road Trail. The District Superintendent has the authority to open and close specific roads and trails to mountain bike use in the park based on Department policy and criteria established for determining environmental and social impacts (see Appendix F for the State Park and Recreation Commission Policy IV.2, Non-Motorized Bike Use).

Castle Rock State Park has opportunities to provide a trail experience where access and low impact use remains a priority in future park management, and complements the preservation of wildlands and diverse resource values.

Goal: Provide appropriate access and opportunities for the visiting public to enjoy the park, while not degrading the natural features and ecological processes.

Guidelines:

- A Unit Trails Plan should be prepared that strives to create opportunities for visitors to enjoy the unique and diverse topography, geology, biotic communities, and scenic views at Castle Rock State Park. The actual location, distance, and use of future trails should be governed by this plan.
- Trailhead connections and signing for interpretive information and visitor safety should be improved throughout the park and at main points of entry along State Highways 9 and 35. A primary visitor contact location, such as a multi-agency visitor center, should be considered for dissemination of regional trails information.

- A loop-trail system should be designated to distribute people throughout the park and encourage use of perimeter parking locations, and to facilitate a balance of trail use that is commensurate with resource values. First consideration should be given to trail routes and connections outside the natural preserve boundaries, such as portions of the Kings Creek Truck Trail, through the use of recreation and/or conservation easements.
- Trails should provide for public access within the park and to adjacent regional trail systems, with priority for achieving unitwide resource management goals and objectives. The Department should support regional trail objectives, coordinate with other land management agencies in the Santa Cruz Mountains vicinity to evaluate and monitor resource conditions, and share information to develop open space management programs and multiple use trail plans on a regional scale.
- Future trails planning and construction should include the Department's specifications and policies concerning trail construction and maintenance, and be coordinated with soil erosion and sediment policies prescribed in the "San Lorenzo River Watershed Management Plan" (Santa Cruz County Planning Department and State of California Resources Agency 1979) or revisions thereof.

UNITWIDE INTERPRETATION

Interpretation is based on the premise that knowledge deepens the park experience and provides lasting benefits not only to individuals but also to society in general. The following describes the interpretive goals for the park and its natural and cultural resources, establishes a period for interpreting the park's cultural resources, and presents the major interpretive themes created to help communicate resource information to the public. If this approach is successful, individuals will have an enriched park experience and, at the same time, help preserve and protect the varied and sometimes fragile resources found here.

Goal: Provide the opportunities to increase the visitors' knowledge and appreciation of the significant natural and cultural resources of the park; to increase their understanding of ecological relationships; and to increase their awareness of, and sensitivity to, human impacts on these resources.

Interpretive Period

The Saratoga Toll Road, completed in 1871, opened the summit area and the park for intensive resource exploitation and settlement. Although most of the redwoods were harvested by the turn of the century, logging continued in the area of the park until 1970. This extensive span of years allows for the discussion of the ongoing and varied

use of parkland resources over the years, and the impacts these varied uses had on the landscape.

Some pre-historic resources exist from the Native Americans who inhabited the Castle Rock area prior to 1770. This earlier period could also provide important and interesting information to park visitors.

Guidelines:

- The primary period for the interpretation of the park's cultural history will be the hundred-year period from 1870 to 1970.
- A secondary interpretive period will include the prehistoric era when Native Americans lived, hunted, and gathered in an area encompassing the present-day park.

Interpretive Themes

Interpretation relies on themes to describe the significant natural and cultural resources of the park in personally meaningful ways. Themes help connect the various pieces of the park so that relationships between plants, animals, topography, climate, soil, and other parts and forces can be better understood. Most importantly, thematic interpretation helps the park visitor understand the role humans have played, and continue to play, in impacting these resources. The unifying theme and the primary themes are given below. Secondary themes that deal with specific natural and cultural features of the park, as well as specific locations, will be presented in the Interpretive Prospectus.

Park Unifying Theme: *Although substantially altered by a variety of human impacts, the recovering Castle Rock State Park provides a glimpse of the original primeval character of the Santa Cruz Mountains.*

From pre-historic Native American burning to 1960s Christmas tree farming, Castle Rock State Park, like much of the Santa Cruz Mountains, has experienced dramatic human manipulation of the landscape. Gold miners and hunters, woodcutters and loggers, cabin and road builders, farmers and recreators have all made their mark. Yet, to the casual visitor, much of the park today has the feel of a rich natural area with a wild character.

The answers to the following questions provide the basis for the major interpretation of the park: What were some of the historic human impacts and what are the current impacts of recreational use? What are the natural forces involved in recovering ecosystems? What must we do to assist in this mostly natural recovery and to avoid further damage to resources? And what resource management measures must be adopted to insure continued recovery?

Theme: *Some of the Park's most significant and sensitive geologic features, and impressive examples of both untouched and recovering flora and fauna assemblages, are given special status in the park's Natural Preserve.*

The proposed 1,800-acre natural preserve recognizes both the significance and the fragility of this area and its resources. The preserve provides habitat for four endangered animal species and several others considered threatened or of special concern to conservation agencies. Four special plant communities are included in the preserve: an ancient redwood forest, a knobcone pine forest, a white alder riparian forest, and a black oak woodland. Relatively untouched and fragile tafoni rock formations and moss covered rock outcroppings are also found here. Interpretation will aim at educating visitors and motivating them to appreciate and cooperate in preserving these resources.

Theme: *Although most of the forested lands within the park were harvested by woodcutters in the late 1800s, natural succession has created mature second growth woodland habitat.*

Beginning in the mid-1800s, tanoak, madrone, and oak were cut for use in the Santa Clara and San Lorenzo Valleys, and most redwoods and Douglas-firs were clear cut later in the century. Yet today, a visit to many of these same forests feels like a walk through untouched wildlands. What are the natural processes that result in regenerated forest land, and how do we best manage these resources to allow these processes to continue?

Theme: *The rugged and undeveloped terrain of the park has protected some animal species, while others have not survived the destruction of their habitat.*

Undeveloped parklands serve as survival islands for some animals, but the extensive historic destruction and disturbance of animal habitat throughout the Santa Cruz Mountains has resulted in the extirpation of several species. What habitat types does the park provide and what conditions are necessary within the park and adjoining lands to encourage the survival and ecological health of native animal species?

Theme: *By becoming responsible stewards of the land, we can preserve the beauty and majesty of this place for future park users.*

In the late 1800s visitors recognized and appreciated the beauty and wildness of the summit area, and one can imagine that earlier Native Americans had a similar experience here. Today's continually expanding population in the greater Bay Area guarantees more intensive use of open space. We all have to be responsible park users to insure that areas like Castle Rock State Park are appreciated, understood, protected, and preserved.

Interpretive Facilities, Programs, and Media

The interpretive facilities, programs, and media that will be the vehicles for conveying this information are described in the following guidelines. These guidelines are presented for application of the unitwide goals and interpretive themes presented in the previous section. More specific guidelines and descriptions of interpretive facilities and programs will be included in the future Castle Rock State Park Interpretive Prospectus.

As the main entry and visitor contact area of the park, Partridge Farm is the one site where limited development of new recreation and interpretive facilities will occur. It will also be a central location for accessing other sections of the park. The existing interpretive shelter is an excellent place where interpretive programs and tours can originate. The Partridge House, a historically significant structure, represents the living style of the farmers of Summit Ridge and the present Castle Rock State Park area in the decades since 1900. The house is currently serving as an employee residence, but also has adaptive use potential and could be used as exhibit space.

Goal: Acquaint the public with the park's resource values and the need for preserving and protecting the significant resources. Update the existing interpretation and provide a place to be used for traditional campfire programs or outdoor classroom.

Guidelines for Partridge Farm:

- The interpretive shelter should serve as the primary interpretive facility in the park with a strong emphasis on interpreting resources of the nearby Natural Preserve. An important interpretive topic would be the people, Judge Joseph Welch and Russell Varian, for example, whose foresight and concern led to the inception of the park.
- A campfire center or amphitheater/scenic viewing area should be developed within easy walking distance of the campsites.
- Guided and self-guided natural history walks should be provided for interpreting significant resources.
- The Partridge House may be considered for adaptive use as exhibit space to interpret Castle Rock State Park, for example, historic agricultural uses.
- Historically significant pear and apple orchards should be maintained and used to help interpret historic agricultural practices in Castle Rock State Park. The nearby historic orchard should also serve to interpret historic fruit growing.

Guidelines for Sempervirens Point:

- Interpretive panels are currently being developed in conjunction with the parking lot improvements at Sempervirens Point. The panels will interpret the panoramic view of the area, identifying mountain tops, the Monterey peninsula, and other significant geographical features. Additional information on park trails and general park orientation should also be provided at this site.

Guidelines for Tin Can Ranch:

- An Environmental Living Program (ELP) where children get an intensive outdoor experience and learn about the ecology of the Santa Cruz Mountains is recommended for Tin Can Ranch. This area already has many of the facilities needed for such a program. The intent is to make use of only those facilities of Tin Can Ranch that are appropriate for the proposed ELP program.

Guidelines for Loghry Woods:

- It is recommended that the Loghry Demonstration Forest and the cultural history of this section of the park be interpreted. However, exotic species that constitute a genetic threat to local species should be eliminated. The abandoned and burned-out Naval Facility in Loghry Woods should also be interpreted.

Guidelines for Parking Lots and Other Entrances:

- The proliferation of directional signs, park regulation signs, information signs, and interpretive signs should be reviewed, and, where possible, consolidated.
- Interpretive material that informs rock climbers of the area's geologic resources, and the care that must be taken to preserve these resources, should be developed for appropriate entrances.

Guidelines for Magnetometer Site:

- It is recommended that the Magnetometer Site, near Castle Rock Trail Camp, be interpreted for its own value as well as the role Russell Varian, early proponent of the park, played in developing it.

Interpretive Collections

The Department acquires and maintains collections for several reasons. First, to preserve elements of the natural and cultural environment original to the park; second, to document the people, events, and cultural or natural features that are central to the park's purpose; and third, to support the interpretation of themes that are important to the park. The collection of both natural and cultural artifacts at Castle Rock State Park will be considered only as they fulfill these criteria. The Department has a legal and ethical mandate to obtain only collections to which it can provide professional curatorial management. Therefore, collections obtained or housed at Castle Rock State Park will be obtained and maintained as directed by Departmental Collections Management Standards outlined in the Department Operations Manual (DOM).

The following is a general Scope of Collections Statement that provides the broad management objectives and guidance for the type of park collections for Castle Rock State Park.

Scope of Collections Statement

Museum collections will play a minor role at Castle Rock State Park. At present, there are no formal museum collections in the park. Museum collections may be acquired when necessary to:

1. Retain elements of the real property, such as archeological and paleontological materials removed from the site.
2. Retrieve objects that were used historically at the site, such as lumbering tools, farming implements, tan bark processing tools, or household items used in the historic farmhouse.
3. Document the natural history of the park, such as herbaria specimens.

Guidelines:

- If museum collection needs are identified during future interpretive planning, they will be incorporated into a revised, and approved, Scope of Collections Statement.
- Collections acquired for or maintained at the park will be managed in accordance with the policies and procedures outlined in *Chapter 20: Museum Collections Management* of the Department's Operations Manual.

UNITWIDE CONCESSIONS

Concession operations in Castle Rock State Park are governed in part by Public Resources Code, Section 5080.02 - 5080.26 et seq. and by the policies of the California State Park and Recreation Commission.

The Department's policy is to enter into contracts to provide services, products, facilities, and programs to enhance visitor use, enjoyment, safety, and convenience; ensure that concession developments, programs, or services are compatible with a unit's classification and general plan provisions; promote concession opportunities inside or outside the unit where they are appropriate and either reduce costs and/or generate revenues to the State Park System; and encourage private-sector capital investment for the development of needed facilities in State Park System units through contracts.

Goal: Provide opportunities to expand visitor services at Castle Rock State Park through contracts and special events.

Guidelines:

- Telescopes located at vista points, overlooks, and scenic stopping points along the highways may be considered a potential concession, which could enhance the visitor's experience.
- The sales of books, publications, and brochures related to the park's natural and cultural history is the role of the cooperating association and should be considered for educational and interpretive value if a park headquarters and/ or multi-agency visitor center is developed at Castle Rock State Park.
- Special events, activities, and uses, such as rock climbing instruction, weddings, and astronomical interpretive events may continue where they remain compatible with resource management objectives and low intensity recreational experiences.
- It is not possible to predict all potential and compatible activities for Castle Rock State Park at this time, specific proposals to contract for services will be considered on a case-by-case basis. Each proposal will be weighed against the purpose, vision, values, and spirit of the park as discussed in other sections of this plan.

AREA GOALS & GUIDELINES

Presented below are guidelines developed for specific areas and/or resource management zones designated at Castle Rock State Park.

NATURAL PRESERVE AREA

Highly significant biotic and abiotic resources are found in the Kings Creek and upper San Lorenzo River drainages. These include rare plant communities, habitat for sensitive animals and plants, spawning areas for sensitive fish, and prime examples of delicate, rare tafoni sandstone outcrops. Most of this area is characteristic of the Santa Cruz Mountains when the first Euro-American settlers arrived, with normally functioning ecosystems and continuous habitats relatively unfragmented by roads or trails.

Ridgetops and upper slopes are covered with mixed evergreen forest, chaparral, and oak woodlands, including a stand of the locally important California black oak. Rare tafoni sandstone formations outcrop in the upper parts of the watersheds. Some tafoni formations are very fragile and easily disturbed by touch, and many are blanketed with moss.

Redwood forests and riparian forests cover the lower slopes and stream bottoms, respectively. Most of the redwood forests exhibit second growth characteristics that are approaching a mature forest stage, while a remnant ancient redwood forest remains in the Kings Creek drainage. The riparian forests in the area are classified as White Alder Riparian Forest, a community recognized as rare by the California Department of Fish and Game.

These varied plant communities and tafoni rock outcrops furnish valuable wildlife habitat. Ancient redwood forest in the Kings Creek drainage provides potential nesting habitat for the endangered marbled murrelet and the sensitive Vaux's swift. This ancient redwood forest has been included in marbled murrelet critical habitat designations by the U.S. Fish and Wildlife Service. Riparian areas of the park support a great diversity of animal life, such as the endangered peregrine falcon, the threatened willow flycatcher and red-legged frog, western pond turtle, and sharp-shinned hawk. Within the park, the San Lorenzo River provides spawning habitat for the threatened steelhead trout.



Differential Weathering in Sandstone Formation

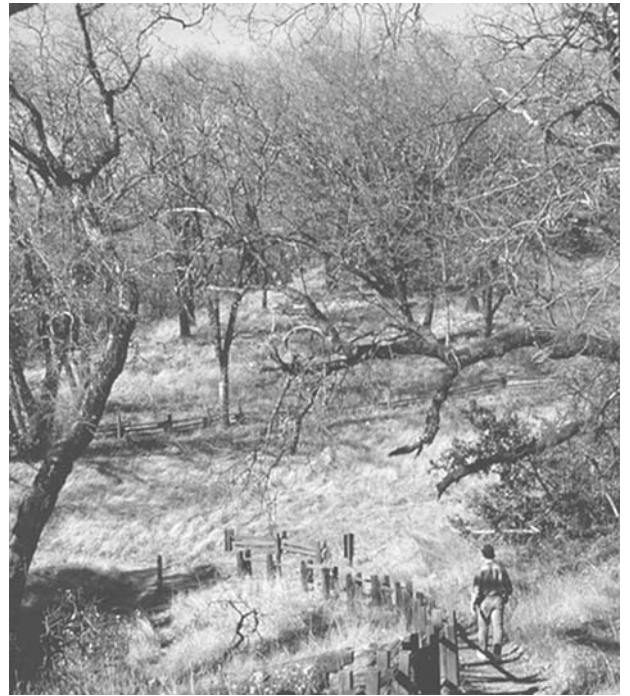

Black Oak Woodland



Kings Creek Aquatic and Riparian Complex

Tafoni sandstone formations, with their crevices and small caves, provide potential habitat for several species of animals such as mountain lions, pallid bats, mastiff bats, bobcats, raptors, and small rodents. Areas in the upper Kings Creek area have tall cliffs with moss covered rock faces, potential nesting habitat for peregrine falcons or other raptors.

Because of the diversity and sensitivity of plant communities and animal life, the presence of pristine tafoni sandstone outcrops, and the relationship of these resources to steep slopes and unstable soils, portions of the Kings Creek and upper San Lorenzo River drainages warrant special protection.

Natural Preserve Classification

Goal: Establish special protection and designation for sensitive plant and wildlife habitats and geologic features in the upper San Lorenzo River and Kings Creek drainages, including the area known as Lion Caves.

The management intent is to establish approximately 1,800 acres in a Natural Preserve Classification, with a primary management philosophy to protect, preserve, and interpret significant resources, and promote natural processes. Sensitive plant communities, wildlife habitats, and geologic features will receive special protection. Visitor use will be carefully monitored and managed on a few trails through the natural preserve. These selective trails will be designed for access with the least impacts, allowing visitors an opportunity to experience the wildness and serenity of the park, without disturbing critical habitats.

Guidelines:

- The primary purpose for management is the protection, preservation, and interpretation of significant resources and management of natural processes without interference. Recreational activity and development within the preserve should be limited to trails primarily for interpretive purposes. Active forms of recreation such as camping, rock climbing, and others that may occur off the trails shall be prohibited in the proposed natural preserve.
- The natural preserve will be managed as a wildlands area where natural processes can occur without interference and which provides opportunities for scientific study of interpretive and educational values, where appropriate.
- Existing and new trails may be considered in the natural preserve for guided and self-guided interpretive opportunities. These limited trails should be designed to provide access in areas where they would have the least impact on wildlife habitat and ecological systems. Future trails development should be guided by a unitwide trails plan and directed by Departmental resource management and

interpretive policies, whereby preservation and resource protection are considered the primary management philosophy in this area.

- Evidence of old logging roads is found in the proposed natural preserve along the San Lorenzo River off the Saratoga Toll Road. These roadways may remain but should not be restored for purposes of preserving cultural features. The old road alignments, where they present erosion and other problems will be surveyed and removed, and appropriate actions will be taken to preserve significant cultural values, while controlling erosion.
- The proposed southern boundary of the 1,800-acre natural preserve is located on the state park boundary where it is contiguous with the San Lorenzo Valley Water District property. Watershed management studies describe this adjacent land as having resource values of exceptionally high quality similar to the proposed natural preserve, including significant stands of late-phase second growth redwoods, historic sites and features, and sensitive plant and wildlife habitats. Our Department and the San Lorenzo Valley Water District should continue to coordinate their efforts for shared watershed management practices and appropriate recreation trails planning.

TRAVERTINE SPRINGS AREA

Travertine Springs is a small, unique area of the park that exhibits travertine mineral deposits issued from natural springs. The wetlands associated with the springs are equally fragile, supporting a tall grass meadow and stands of willow, bay, and hazelnut. This is the only place of occurrence of this rare and fragile feature in Santa Cruz County.

Goal: Maintain, protect and perpetuate the Travertine Springs area of Castle Rock State Park.

Guideline:

- The Department should develop and implement an area specific area plan that provides for the protection and preservation of the Travertine Springs features occurring in the park.

PARTRIDGE FARM AREA

To satisfy the unitwide goal for improved visitor contact, the Partridge Farm area was selected because of its topography, characteristics, prior uses, easy access, open space, and proximity to the primary visitor use areas with on-site ranger presence. The resource sensitivities are considered slight on this site, although there are special plant, wildlife, and geologic features in adjacent areas. It has the most potential of any area in the unit to provide visitors with the awareness of a park management presence, and to provide organized access.

The site is accessible from State Highway 35, and has available water and power and easy access to trails, scenic overlooks, trail camps, and popular climbing areas. The interpretive shelter, located at a trailhead on the southern edge of the farm site, provides interpretive information and shade cover for hikers, and serves as a focal point for occasional special events, such as outdoor weddings or group celebrations. Astronomers gather on a knoll nearby to view the stars under the dark skies. Partridge Farm is currently used for short-term parking during these special events. Castle Rock Falls and Goat Rock are among several popular climbing areas located a short distance from Partridge Farm. Another nearby visitor attraction includes the scenic overlook.

The primary concern in any future development and use of this area is the potential impact on the natural and cultural resources of this site and the adjacent areas. The Lion Caves, an area with moss-covered tafoni sandstone formations, is located one-half mile to the west in the proposed natural preserve. Development of the Partridge Farm is expected to increase visitor use in the adjacent areas. Because of the differences in management philosophy in the nearby Resource Management Zones (e.g., natural resource management and recreation enhancement at Castle Rock Ridge RMZ; special protection at Lion Caves RMZ), different standards of acceptable change are likely.

Goal: Establish Partridge Farm as an entrance (or portal) into Castle Rock State Park. As such, it will provide for improved vehicle access, visitor contacts, parking, orientation, and interpretive facilities at the park's perimeter. The level of recreational activity and use provided at Partridge Farm will be consistent with and complement the resource management objectives of adjacent RMZs.

Partridge Farm Area Land Use Management and Development

The management intent is that the Partridge Farm Area provides the primary access, contact, and orientation for visitors to Castle Rock State Park. For most visitors, this entrance area will serve as the main trailhead parking and transitional zone between the park's wildland areas and the urbanized setting from which they come. Management will establish a new park headquarters area on this site that provides basic visitor

services and information, with programs stressing park values and recreational opportunities. The open-air interpretive shelter will exhibit known natural and cultural features, and occasionally serve as an outdoor classroom. New facilities will be esthetically designed to blend with their surroundings and respect the environment and its preservation. The entry experience for visitors to Castle Rock State Park, through Partridge Farm, will prepare visitors for a wildlands experience they will get when entering the trail system beyond.

Future management and use of the Partridge Farm Area will be guided through proper site planning and on-going evaluation of resource conditions, as well as understanding visitor and operational needs. The introduction of public access and use to this site will transform some of the current open space to developed parking, buildings, and outdoor use areas. However, the predominance of open space will be preserved and native vegetation reestablished to provide wildlife habitat and serve as a buffer between facilities and surrounding natural areas. Visitors can be oriented to the appropriate use areas and informed about the resource values and park rules and regulations. The Department will focus on mitigating visitor impacts in sensitive resource areas, establishing the initial public contact and operating functions, and improving access for people with disabilities.

An overall site plan will be prepared for the Partridge Farm Area, reflecting a phased approach to future development (see guidelines). This proposed change in land use will involve the design and construction of parking lots and entrance road in areas previously developed before the land became a state park. The design process will integrate facilities and vehicle and pedestrian circulation into the site with the least impacts on resources and surrounding activities. This site transformation and changes in the patterns of use will occur incrementally. The first phase of new parking at Partridge Farm will be managed for the primary visitor access and use of the Castle Rock Ridge area. Initially, any spaces retained in the existing Castle Rock main parking lot could serve as a secondary access for trail use. Roadside parking will be removed along the highway outside both of these parking areas. The Partridge area parking will serve first time visitors and others coming to the park headquarters office, as well as for special events. Visitors will be directed to trailheads and designated perimeter parking areas, depending on their interests and need for visitor services. Ultimately, the goal is for the Partridge Farm area to become the primary entrance and day use parking area, where visitor use can be effectively managed and resources protected.

Guidelines:

- Development will be guided by the intent to provide a sense of place, consistent with the park's wildland values. Such development will provide for the restoration and protection of natural and cultural resources and should include interpretation of such values. Development should focus on visitor contact, orientation, and

programs for resource education and awareness. Day use parking, including overnight parking for trail camps, and visitor facilities should be provided to support program needs. These facilities will be located away from sensitive areas.

- Establishment of day use parking and other facilities at Partridge Farm will include an assessment of the ecological and social conditions for the adjacent areas of the Black Oak Woodland, Lion Caves, and Castle Rock Ridge Resource Management Zones. It is the goal to apply processes and methods of visitor management to minimize resource impacts.
- With the guidance of resource inventories, studies, and review, an overall site plan will be prepared for Partridge Farm. This site plan should include components for vehicle access, visitor contact, park office, parking and circulation, day use areas, interpretive and operations facilities, cultural protection, buffer zones, and native plant restoration. Site planning should establish a significant buffer between facilities and sensitive resources, and consider the separation of day use, overnight use, and administrative areas, and include reforestation (with native species) of open space areas surrounding public use facilities.
- Existing structures and utilities may continue to serve for employee housing or appropriate adaptive uses (e.g. park office, interpretive exhibit space), storage, maintenance, and visitor services, so long as they are needed and remain compatible with resource management objectives. New park facilities shall not degrade the site's historic integrity.
- Day use parking should be provided; including support facilities, such as restrooms, potable water, and appropriate trails (Refer to Parking and Access Guidelines). An outdoor visitor program area and scenic overlook may be considered for development. Development projects shall include restoration and protection of native vegetation and protection of cultural features.
- An entrance station or kiosk could be situated at the main entrance road to Partridge Farm and used for park orientation, visitor information, and fee collection. The Partridge house could also serve this function as a park headquarters office.
- Facilities planning and design should consider the potential of astronomy activities and avoid impacts from surrounding area lighting. However, resource management practices shall not be changed to perpetuate sky viewing, such as tree removal or other such measures.
- Volunteer patrols, docent guides, and interpretive planning and program activities should be included in park operation functions. Office space and indoor-outdoor

work areas should be considered for program preparation. Facilities at Partridge Farm, Tin Can Ranch, and potentially at Saratoga Gap may provide for such activities. Other locations off-site may be considered as well.

- If additional lands suitable for development become available from willing sellers, alternative design solutions could be explored for vehicle access, entrance road, and facility locations in the vicinity of Partridge Farm,

Partridge House

The house at the historic Partridge Farm, an agricultural area dating to about 1885, represents the farmstead of early domestic apple and pear production. The house, minus the porch added by the Department, dates to 1924. This bungalow-style farm house represents the middle era of fruit production in the Castle Rock area. In 1998, the house and immediate grounds are used as a residence for the on-site ranger.

Goal: Maintain the “Partridge House” as an example of agricultural residency in the Castle Rock area, with consideration of appropriate adaptive uses.

Guidelines:

- The use and any alterations of the structure shall be guided by Department codes for historic preservation, and general plan guidelines.

Historic Orchards

The existing apple and pear orchards on the parcels once owned by the Craig, Smead, and Partridge families represent, even in their ravaged conditions, the once-hardy agricultural endeavors of the people who struggled to survive economically in this area of the Santa Cruz Mountains. It is not known if the existing pear and apple trees represent an historic mountain orchard, or pre-hybrid historic varieties. However, interpretation of these former orchards will play a major part of the history of the area.

Goal: Maintain, protect, and perpetuate, if determined historically significant, the historic orchard and any historic varieties.

Guidelines:

- The Department should determine the historic nature of surviving trees and take appropriate measures.

Prehistoric sites

There is a significant cluster of six prehistoric sites in the Partridge Farm area. These sites represent a seasonal camp of undetermined age. Refer to the unitwide goal and guidelines for protection of prehistoric sites on page 67.

Accessibility

Goal: Expand access opportunities for visitors, physical barriers, and provide equal accessibility to all programs and facilities.

Support facilities will be designed for accessibility in accordance with ADA guidelines, and sited with minimal impact on resource values. Prior to facility development, a resource assessment will be implemented in order to direct management on development, use limitations, and public access to the Partridge Farm Area and its surroundings. The restoration and protection of the natural communities in the area will offset unavoidable impacts associated with any development. As well, there is a commitment to provide quality interpretation of the natural and cultural values therein. Such interpretation is intended to stimulate an awareness and appreciation by all park visitors to share in the protection and preservation of these resource values.

Guidelines:

- Automobile parking should be screened with native plants.
- Restroom facilities should be small in scale and blended into the existing terrain and landscaped with native vegetation.
- Pathways connecting to park trails shall guide users through the least sensitive resource areas.
- Provisions should be made for people with disabilities.
- Programs and development in the State Park System are currently guided by the ACCESS TO PARKS GUIDELINES document, dated May 1999, on file in the Human Rights Office of our Department. These guidelines are subject to continuous review and periodically updated as new information becomes available. Additional State and Federal guidelines may also apply.

The management intent is to establish approximately 20 walk-in campsites in the Partridge Farm Area. These campsites will be designed for a visitor experience similar

to trail camps, but with greater accessibility to parking and restroom facilities. Visitors will be required to walk a reasonable distance from a common parking area to walk-in campsites situated in a natural setting. Unlike automobile campgrounds, campers will not have vehicle parking next to each campsite. Campsites and support facilities will be designed to create an accessible environment for visitors and minimize visitor impacts on natural and cultural resources.

Walk-in Campsites

A General Plan Amendment and Supplement EIR was prepared and approved by the Commission on October 25, 2000, which included overnight provisions for walk-in campsites at Partridge Farm. The additional goal and guidelines for overnight use are described below. The complete GP Amendment document can be found in Appendix H.

As directed by the general plan, an overall site plan will be prepared for Partridge Farm, with the guidance of resource inventories, studies, and review. This site plan will include such components as: vehicle access, visitor contact, park office, parking and circulation, day use and overnight use areas, interpretive and operations facilities, cultural protection, buffer zones, and native plant restoration. The proposed campsites would be developed in a third phase of park development, only after the first two phases, which includes day use parking and visitor contact facilities. Resource assessment and monitoring will occur in the vicinity of Partridge Farm prior to development, which is subject to further environmental review.

GOAL: Expand access and overnight opportunities for visitors.

Guidelines:

- Approximately 20 walk-in campsites may be developed for a tent camping experience in the Partridge Farm Area. Campsites will be set into a natural setting and accessible by trail to and from developed parking and restroom facilities located out of view from the campground.
- Overnight visitor parking (approximately 30 spaces) will be screened with native plants and centralized or clustered away from the walk-in campsites.
- Restroom facilities will be small in scale and blended into the existing terrain and landscaped with native vegetation. Restroom locations shall be based on the overall site plan prepared for the Partridge Farm Area, including provisions for day use and overnight use facilities.

- The design and layout of campground facilities shall consider compatibility with other uses and programs (i.e., day use, special activities, operations, natural and cultural resource management, and interpretive programs) identified in the general plan for the Partridge Farm Area.
- Pathways connecting campsites to park trails shall guide users through the least sensitive resource areas.
- Campsite provisions should be made for people with disabilities.
- Prior to any facility development, a resource assessment and monitoring program will be implemented in order to evaluate impacts and guide future management decisions regarding public access and visitor use in the Partridge Farm Area and its surroundings. Development projects shall include provisions for the restoration and protection of native vegetation and protection of cultural features.
- A campfire center may be considered in the overall site plan for the Partridge Farm Area.

GUIDELINES FOR MULTIPLE AREAS

The management intent for wildland areas surrounding the Partridge Farm and proposed natural preserve is to preserve natural resource values, protect cultural sites and features and to provide access opportunities. Recreational activities will be managed and regulated to minimize visitor impacts on resources. Designated trailheads along State Highways 9 and 35 will be improved with upgrades in safety, services, and visitor orientation.

The following goals and guidelines pertain to the management and use of areas outside the natural preserve and the Partridge Farm Area; including rock climbing, parking and access, trail camps, and the protection of historic sites and features.

ROCK CLIMBING

The resource sensitivity and the wild character of the park indicate that only low-impact recreation can be considered appropriate. The primary management concerns include visitor safety, resource impacts, volunteer trail proliferation, and unauthorized climbing and access in the natural preserve and areas closed for rehabilitation.

Goal: Manage Castle Rock State Park for protection of significant resource values and opportunities for low-impact recreation, including rock climbing.

Guidelines:

- A Climbing Management Plan will be prepared in coordination with the climbing community to establish appropriate guidelines for climbing that protect geologic features and significant natural and cultural resources.
- The District should form a partnership with the climbing community to encourage participation from climbers, to help enforce climbing policy and rules, and to assist in the implementation of trail and rock restoration, and other mitigation projects. This coordination with the climbing community should promote an environmental ethic and assist in the clarification and acceptance of the climbing rules for park visitors (see Appendix G for the Department's climbing policy).
- The portion of the black oak woodland (approximately 55%) lies within the proposed natural preserve, where restoration and preservation is paramount. The remaining portion of the black oak woodland is located in the Castle Rock Ridge Resource Management Zone (RMZ) where most climbing occurs. While this RMZ allows for low-impact rock climbing, protection of the black oak woodland and resource preservation will remain the primary management philosophy within this zone.
- The resources and recreational activities outside the natural preserve will be managed with methods that ensure protection of significant resource values and that maintain compatibility with adjacent park land uses. This will include consultation with scientific and environmental specialists and other land managers and recreation providers to coordinate policy formation and systems management for long-term resource protection and public access.
- The Department should rehabilitate impacted areas with eroded soils and take appropriate actions to minimize resource damage along trails and at climbing locations.
- The Department should improve access trails and signing based on a unitwide trails plan, including information on climbing and park rules, regulations, and resource sensitivities.

PARKING AND ACCESS

This plan includes parking recommendations to help satisfy operational needs and address resource management and visitor concerns. Current problems for parking and visitor safety relate to the multiple access locations and the random parking arrangement on the highways. Parking demand, during peak periods of use, exceeds the current capacity at the main parking lot near Castle Rock. During this same period, free roadside parking is available in other areas. Parking is desirable at trailheads and primary access locations. Visitor needs for parking will vary with the type and amount of use desired for a specific area. Provisions for day use and overnight visitor parking are directed by the following goals and guidelines.

Goal: Satisfy operational needs for improving the management of access and parking for visitors.

Guidelines:

- Retain roadside parking areas where appropriate.
- Provide trailhead parking facilities for access to regional trails.
- Provide safe and secured day use and overnight parking areas.
- Consolidate visitor parking areas to avoid multiple contact stations, if possible.
- Provide short-term parking for dissemination of park/regional trails information.
- Provide parking for people with disabilities.
- Provide parking opportunities for groups by special use permit.
- Provide drop-off location and bus parking where feasible.
- Provide parking for horse trailers.

Phased Parking Development

During the preparation of this general plan, it was determined that a phased approach to development at Partridge Farm would provide the best means to serve visitor needs and minimize resource impacts.

Highway pullouts are projected to continue to serve the same general distribution of visitors that presently exist, with potential for redistribution to improved parking areas along State Highway 9 and some reduction in other locations. This general plan proposes to relocate the existing main parking to the Partridge Farm area, in part or in full, but would not increase day-use parking capacity or overall visitor attendance due to parking.

Goal: Relocate the park entrance and main parking area to Partridge Farm. Phasing will allow for monitoring resource impacts and changes in visitor use, and determining the appropriate management actions to minimize resource impacts.

Guidelines:

- Subsequent changes in the patterns of use should occur incrementally, so that visitors can be oriented to the appropriate areas and informed about the resource values and any new changes in park rules.
- The Department will perform site investigations and resource assessments to determine appropriate management actions and recommended mitigation.
- Actions should be initiated through Caltrans for highway parking restrictions and access requirements in conjunction with plan development at Partridge Farm.
- Day use parking at Partridge Farm would consist of two phases:

Phase 1 - Manage day use parking at Partridge Farm in conjunction with the existing Castle Rock parking lot for an overall capacity of approximately 100 cars between the two parking areas. Request Caltrans to post “no parking” signs for approximately 2 miles along State Highway 35, south of Summit Rock parking lot.

Phase 2 - If the results of visitor assessments and resource monitoring support the initial parking capacity in Phase 1, then additional parking could be developed at Partridge Farm. Parking would be removed from the existing main parking lot, with no net increase in overall day use parking capacity for this area. Alternatively, the parking arrangement could vary between the two parking areas, based on the outcomes from resource monitoring and management of visitor impacts. If a portion of the existing main parking lot remains, then problems with surface run-off should be mitigated; in addition, contact with park staff based at Partridge will need to be considered.

Overnight Parking

Existing trail camps require parking spaces for overnight use. Backpackers, or campers who hike into the existing trail camps use the main parking lot. Currently, spaces in the existing main parking lot are allocated at nighttime for this purpose. The general plan guides the development and management of visitor parking and potential trail camp locations.

Goal: Provide parking for overnight use areas.Guidelines:

- Day use parking spaces in the existing or proposed parking lots may be allocated for overnight use of existing trail camps. The needs of resource management, trail camp users, and day use visitors should be considered in determining future parking lot capacities. The location and estimated number of parking spaces required by trail camp users depends on the total number of campsites and the use they receive.
- Parking layout and lighting designs should also consider potential dark sky viewing by amateur astronomers.

Highway Roadside Parking

The multiple access locations and trailheads are served by roadside parking areas along portions of State Highways 35 and 9. The following guidelines will help direct future management of roadside parking and access in conjunction with developed parking lots.

Goal: Consolidate parking for appropriate access and effectivenessGuidelines:

- Parking lots near existing trailheads should be upgraded with interpretive and information panels and restrooms. The best possibilities include Sempervirens Point, Red Mountain, Oil Creek, and Waterman Gap. Tin Can Ranch may serve also for trailhead parking if compatible with other priority uses proposed there. Smaller roadside parking areas should be removed if determined necessary through further evaluation and coordination with Caltrans.
- The Department should coordinate with Caltrans to evaluate existing roadside parking areas along State Highways 35 and 9 for possible closure or improved parking use and trailhead access.
- Management of roadside parking along State Highway 9 should consider accommodations for parking a horse trailer where there is sufficient size and easy access to equestrian trails (for example, at Hoe Gate and Oil Creek parking lot).
- The Department should coordinate with Santa Clara County, Midpeninsula Regional Open Space and Caltrans for parking management and use at the

Summit Rock and Vista Point parking lots. These parking lots are located on Caltrans property or highway right-of-way and provide visitor access to trails and rock climbing sites in the state and county parks and regional open space. Uniform signing and regulations for appropriate parking and use are desirable at all designated parking potentially used by visitors to Castle Rock State Park.

- Considerations for the amount and disbursement of visitor parking made available along both highways will be included in establishing a basis for managing visitor use of the park.

Trail Camps

The primitive nature of the Castle Rock Trail Camp and overall visitor camping experience is being impacted by the presence of park vehicles, old structures, and operational facilities (See Existing Conditions on page 38). Trails and road corridors were investigated to determine if other potential trail camp locations existed in the park. Due to the steep terrain and resource sensitivity, very few sites met the criteria for establishing additional trail camps without causing further resource damage. The two areas that were identified for possible campsite locations include: (1) Hall's Rest Stop site at the intersection of the Saratoga Toll Road and Beekhuis Road Trail, and (2) a site off the Travertine Springs Trail east of the San Lorenzo River and north of Craig Springs Creek. These potential campsite locations could accommodate approximately 6 sites each.



Existing campsite at Castle Rock Trail Camp

Goal: Rehabilitate existing campsites and trails, and restore the primitive camping experience.

Guidelines:

- Remove or relocate existing structures and restore plant and wildlife habitat at the Castle Rock Trail Camp. The existing Boy Scout-constructed shelter could remain and be considered as a possible site for interpretive panels.
- The design and location of existing campsites should be reevaluated to determine impacts to plants and wildlife habitat. Campsites should be removed, where necessary, to minimize detrimental impacts to resource values. The existing campfire center at the trail camp could be removed if a new campfire center is developed at the Partridge Farm.
- The Department should continue to coordinate with the San Lorenzo Valley Water District to maintain a trail camp at Waterman Gap. Trail access and campground use should remain compatible with adjacent land uses and not diminish natural or cultural resource values.
- Alternative trail camp locations should be investigated (potential site at the intersection of the Saratoga Toll Road and Beekhuis Road Trail, and a site north of Craig Springs Creek off the Travertine Springs Trail) if future sites are needed due to campsite removal, or if recreational needs are not being met at existing campgrounds. Prior to establishing trail camp use in these areas, further cultural investigations and site studies are required. All trail camp amenities and use shall be governed by the elements of a unitwide Trails Plan.

HISTORIC FEATURES

The “Saratoga Toll Road,” originally known as the “San Lorenzo Valley River Road,” is a historic wagon road that served various economic activities along the flanks of the San Lorenzo River from 1871 until the creation of State Highway 9 in 1916. The road, while never a financial success as a toll road, was an early historic road that demonstrates the local effort to connect Boulder Creek and Saratoga and the various settlers along its route. This road is presently used as a trail route that runs parallel to the San Lorenzo River. Despite continual natural damage to the roadway alignment, the “Saratoga Toll Road” is a historical entity.

There are four historic roads, in addition to the Saratoga Toll Road, that should be considered historically significant:

- A. The “Smead-Damond-McDonald Road”, a portion of which is known today as the Kings Creek Truck Trail. It provides non-public access to park and private properties.
- B. The “Craig Road” (after A. F. McDonald Craig) is now a service road and trail from Highway 35 to the campground.
- C. The “Louis Seek Road” alignment. A portion of this road alignment lies under the Indian Rock Ranch Road, and the remaining section is used as the Saratoga Gap trail from the main campground to its intersection with private property to the north.
- D. The John W. Chace Road, which has been almost completely overlaid by State Highway 9 from Saratoga Gap to the Sempervirens Point Parking Lot. The Chace Road is comprised of small turnouts or former bends. These segments are indistinguishable from the early gradings of State Highway 9 without further scientific study.

Just west of the crossing of the Beekhuis Road and the Saratoga Toll Road is the archaeological site of William H. Hall’s “rest stop or tavern” developed in 1872. The tavern complex likely featured a two-story structure and a large flat area that could have contained a barn, outbuildings, hay yard, and corrals. No description of these facilities has been found. The rest stop was closed and out of business by 1885. The site of Hall’s “rest stop” requires additional historical and archaeological research to evaluate its historic significance and to determine appropriate management actions.

Goal: Preserve the historic integrity of old roads and sites that are determined significant to the history of Castle Rock State Park.

Guidelines:

- The use and maintenance of the Saratoga Toll Road alignment should respect its historic value.
- The historical alignments of the other significant historic roads should be retained for their interpretive value.
- No ground-disturbing activities shall take place in the vicinity of Hall’s Rest Stop until professional archaeological investigations can determine its significance and required protection.
- These historic sites (Hall’s Rest Stop, Louis Seek/A.F. Craig Cabin Site) should be included in the interpretive program, if further research substantiates their historic significance.

SARATOGA GAP

PARK ADMINISTRATION

Park administration functions presently occur at various locations, including: the Santa Cruz District Office, Santa Cruz Mountain Sector Office at Big Basin Redwoods State Park, Portola Redwoods State Park, and at the park office trailer and residences at Castle Rock State Park. If the Caltrans property at Saratoga Gap (former maintenance facility) became available in the future, it could serve for State Park administrative and maintenance functions. Vehicle access to this site is shared with private residences in the Indian Rock Ranch Subdivision, therefore, this area would not work well for public use facilities.



Former Caltrans Maintenance Yard at Saratoga Gap

Goal: Provide for park administrative and maintenance functions

Guidelines:

- The Department should consider acquisition or property transfer of the Caltrans Maintenance Yard site located at Saratoga Gap for possible state park administrative and maintenance operations. The existing Caltrans site, structures, and parking should be evaluated to determine their possible use. If acquired, a conceptual site plan should be prepared to illustrate long-term development potential, desired access, circulation, and appropriate facilities.

Structures at Tin Can Ranch may also be considered for administrative or maintenance functions if the Caltrans site is not available.

MULTI-AGENCY VISITOR CENTER CONCEPT

A proposal to develop a multi-agency visitor center at Saratoga Gap was conceived during the 1980s and resurfaced during this general planning effort for Castle Rock State Park. The Department recognizes that the Saratoga Gap is still a candidate for this type of facility and acknowledges that it should be a consideration in future feasibility studies. The facility would serve more than Castle Rock and should include other agencies as well as alternative sites outside this state park. Future studies will also need to evaluate traffic conditions and potential environmental impacts.

Goal: Consider a multi-agency visitor center facility in the vicinity of Castle Rock State Park that could serve park visitors with an orientation to the entire Santa Cruz Mountains, including state parks. It could supplement the park's interpretation through exhibits, brochures, and publications on recreation opportunities and the natural and cultural history of this entire region.

Guidelines:

- The multi-agency visitor center should not focus just on Castle Rock State Park. The visitor center could include office space for staff and/or volunteers, exhibit areas, and sales counters, as well as visitor parking, depending on agency needs and the location of the site and its physical constraints. If located at Saratoga Gap, parking for a visitor center should be planned and managed to give priority to short term visits and fewer parking spaces. Trailhead or long-term parking for other day use visitors should be planned at other locations.
- The Department should continue to coordinate with the Midpeninsula Regional Open Space District and the Santa Clara and Santa Cruz County Parks and Recreation Departments, to determine agency needs and the potential for serving the visiting public in the Santa Cruz Mountains Region.

Blank page



ENVIRONMENTAL ANALYSIS

Blank side of divider page

ENVIRONMENTAL ANALYSIS

SUMMARY

The general plan, with all its sections, constitutes an environmental impact report (EIR), as required by Public Resources Code Sections 5002.2 and 21000 et seq. It will be submitted to the California Park and Recreation Commission for its approval. This general plan and EIR is the first tier of environmental review. "Tiering" refers to using the analysis of general matters contained in a broader EIR (such as one prepared for a general plan or policy statement) with later EIRs and negative declarations on narrower projects; incorporating by reference the general discussions from the broader EIR; and concentrating the later EIR or negative declaration solely on the issues specific to the later project (State CEQA Guidelines, CCR Section 15152). The discussion of impacts is commensurate with the level of specificity of this plan. No other agencies have jurisdiction or permit approval over this general plan.

This general plan proposes facilities development and changes, operational changes, resource management proposals and classification recommendations. The initial impetus for this general plan was the mitigation of impacts arising from existing activities and conditions. Nearly half of the park is proposed for a natural preserve classification. Prescribed burning is proposed to reintroduce fire into the ecosystems, which will maintain and possibly expand native plant communities. The creation of a centralized visitor contact point at Partridge Farm will permit better visitor control and allow the provision of better public sanitation facilities. Revegetation with native plant species of the undeveloped portion of Partridge Farm will expand native plant communities, improve esthetics, and provide additional wildlife habitat. These actions will also provide mitigation for the impacts from the relocation of day use parking. The park administrative function will be relocated from the existing campground to one of three possible locations - Partridge Farm, Tin Can Ranch, or the Caltrans maintenance yard. The park headquarters office will be relocated to Partridge Farm for primary visitor contact. Vegetation management, trails, and climbing management plans are proposed. The development of a resource impact assessment and management program to set limits on use and development is proposed. Significant environmental impacts are those commonly associated with visitor use and facility development - traffic, visual, and disturbance or loss of sensitive species and habitats. The mitigation generally requires resource specialists to review and select sites avoiding or reducing potential impacts, and will be implemented as specific projects are proposed.

The Notice of Preparation was circulated to State agencies and local planning agencies. Public meetings have been held to solicit public input on the plan proposals and the issues. The issues raised in the process were: climbing impacts and management, protection of sensitive resources, traffic, need for public facilities (water, restrooms, parking, etc.), desire for recreational opportunities (particularly rock climbing and mountain biking), and conflict of uses (particularly with mountain biking). The General

Plan cannot address all of these issues in detail, as it is the first level or tier of planning for a park unit. This general plan sets the broader goals for the unit's management and provisions for public use. It does not define the specific details of development or the methods that will be applied to goals for resource protection. Those details are part of future planning steps that may include layout and design of facilities or specific resource management plans and process. Another level of environmental analysis is applied at that time.

PROJECT DESCRIPTION

The *Introduction* and *The Plan* section of the general plan discuss developmental proposals, appropriate land uses, operational and resource management issues, etc. These sections of the general plan constitute the project description.

The objectives of the *Environmental Analysis* section are to identify the significant impacts of implementing the general plan, and provide general mitigation measures for a first tier of environmental review. Following the approval of the general plan by the California Park and Recreation Commission, the Department will prepare management plans (i.e. climbing, vegetation, trails, etc.) and area development plans as staff and funding become available. The area development plans will provide specific layout, capacity, facilities, configuration, etc. for a designated area such as Partridge Farm or Tin Can Ranch. Implementation of the area development plans will generally be carried out through major and minor capital outlay projects. At each planning level (whether it is a management or area development plan, major capital outlay or minor capital outlay project), the plan or project will be subject to further detailed environmental review to determine if the project is consistent with the general plan and identify any significant environmental impacts and mitigation that are specific to the project. More detailed environmental review will be possible at those levels of planning where facility size, location, and capacity will be more explicitly delineated than at the general plan level.

The proposed plan calls for the preparation of climbing and trails plans, and a comprehensive resource management program. Climbing will be prohibited within the proposed natural preserve. A climbing management plan is proposed for the areas outside of the natural preserve. The park headquarters/visitor contact point will be moved to the Partridge Farm from the existing campground. Partridge Farm will be developed in phases to provide day use parking (estimated in the first phase to be 50 spaces). A baseline resource study and visitor impact monitoring program to provide limits and directions for development and management is recommended. Approximately 1,800 acres of the unit is recommended for classification as a natural preserve.

DESCRIPTION OF THE ENVIRONMENTAL SETTING

Refer to the Existing Conditions Section for a description of the existing environment and significant resource values. Additional traffic, esthetics, and air quality information is below.

Air Quality

Castle Rock State Park is in the North Central Coast Air Basin and Monterey Bay Unified Air Pollution Control District (MBUAPCD). The North Central Coast Air Basin is currently in attainment for federal particulate (less than 10 microns) standards, and federal and state standards for nitrogen dioxide, sulfur dioxide, and carbon monoxide. The Air Basin is not in attainment for federal and state standards for ozone and state standards for particulate matter (less than 10 microns). Air quality is generally good due to the inflow of clean air from the Pacific Ocean.

Esthetics

The two predominant esthetics factors at Castle Rock State Park are visual and audible. The determinations of quality and impact are subjective and are influenced by expectations. Those visitors seeking a "wilderness experience" can have the quality of their visit significantly diminished by the presence of climbing bolts and chalk on the rock faces, the background noise of the highway and aircraft, or the echo of gunshots from the neighboring gun club. These are all existing conditions. Visitors, desiring an active recreation experience, may be less affected by the same intrusions.

The three main existing noise generators in the Castle Rock area are automobiles, aircraft, and the gun club near Partridge Farm. Distance and terrain ameliorate most of the noise impacts from the highway and the gun club for much of the park. However, along Castle Rock Ridge, the noise level may be found excessive by some visitors. The Los Altos Road and Gun Club, which predates the park establishment, is open to the public Thursday through Sunday.

Visual qualities of the Castle Rock State Park are generally rated high with only specific points having negative values (eroded areas, parking areas, trash or litter piles). Middle-ground and background views usually appear unimpacted by human beings. Most of CRSP slopes face the west and the viewshed is comprised of the relatively undeveloped coastal range in Santa Cruz County. The high voltage powerlines cutting through the San Lorenzo River valley are an intrusive visual element. Partridge Farm has been recognized by amateur astronomers as having a valuable "dark sky" resource; there is a clear view of the horizon and low light pollution.

Traffic and Parking

Figure 3 shows the 1992 traffic levels on the three state routes (9, 35, and 236) around Castle Rock State Park. ADT is Average Daily Traffic, the total traffic of a time period divided by the number of days (year or month). It should be noted that the highest peak hour traffic volume on SR 9 was recorded in the winter during the morning commute. There are traffic delays at the 4-way stop intersection of SR 9 and 35. Figure 4 shows the breakdown of traffic flow through the Saratoga Gap intersection from two different hours of observation on one day. This diagram indicates the relative volumes of traffic through the intersection; it is not a complete study. For example, 225 vehicles (205 eastbound and 20 westbound) entered or left the Saratoga Gap intersection on S.R. 9 to Santa Cruz.

Caltrans rates level of service on roadways with a scale from A to F. The rating is not wholly dependent on the number of vehicles but also on the nature of the flow, speeds, and delays. Level of service A represents unrestricted operation; level F represents overcapacity flows with heavy congestion and considerable reductions in speed. Level C is still stable flow; although it approaches the range where instability may occur because of small changes in flow. Caltrans design standard level of service for freeways and highways is "C." Maximum volume (passenger cars per hour in one direction) for rural two-lane highway for B level of service is 900 under ideal conditions (Fundamentals of Traffic Engineering, 8th Edition, Institute of Transportation and Traffic Engineering, University of California, Berkeley, 1973). The values for peak hour volume, one way, on State Route 9 are well below this value. Levels of service for 9 and 35 adjacent to the park are probably A and B most of the time.

The main Castle Rock State Park parking lot off State Highway 35 provides 55 parking spaces. There is no left turn channelization at this entrance; at current traffic levels and site distance, this has not been a problem. State Highway 35 from Saratoga Gap to a mile past the main parking lot is either posted no parking or parking is limited to the day use. There are approximately 384 roadside parking sites available on the two highways bordering Castle Rock State Park (See Table 4 in Appendix E).



Intersection of State Highways 35 and 9 at Saratoga Gap

Figure 3
TRAFFIC VOLUMES

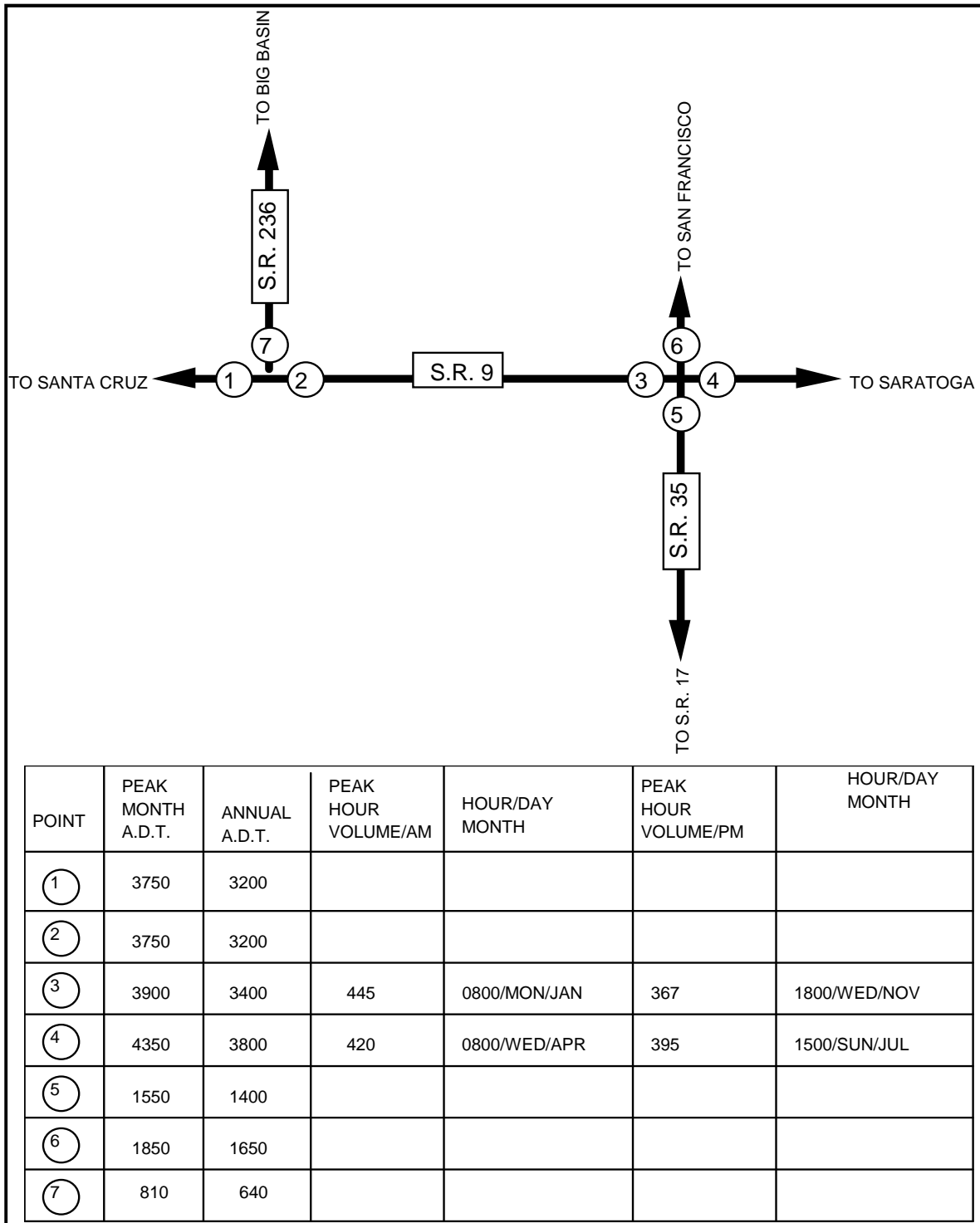
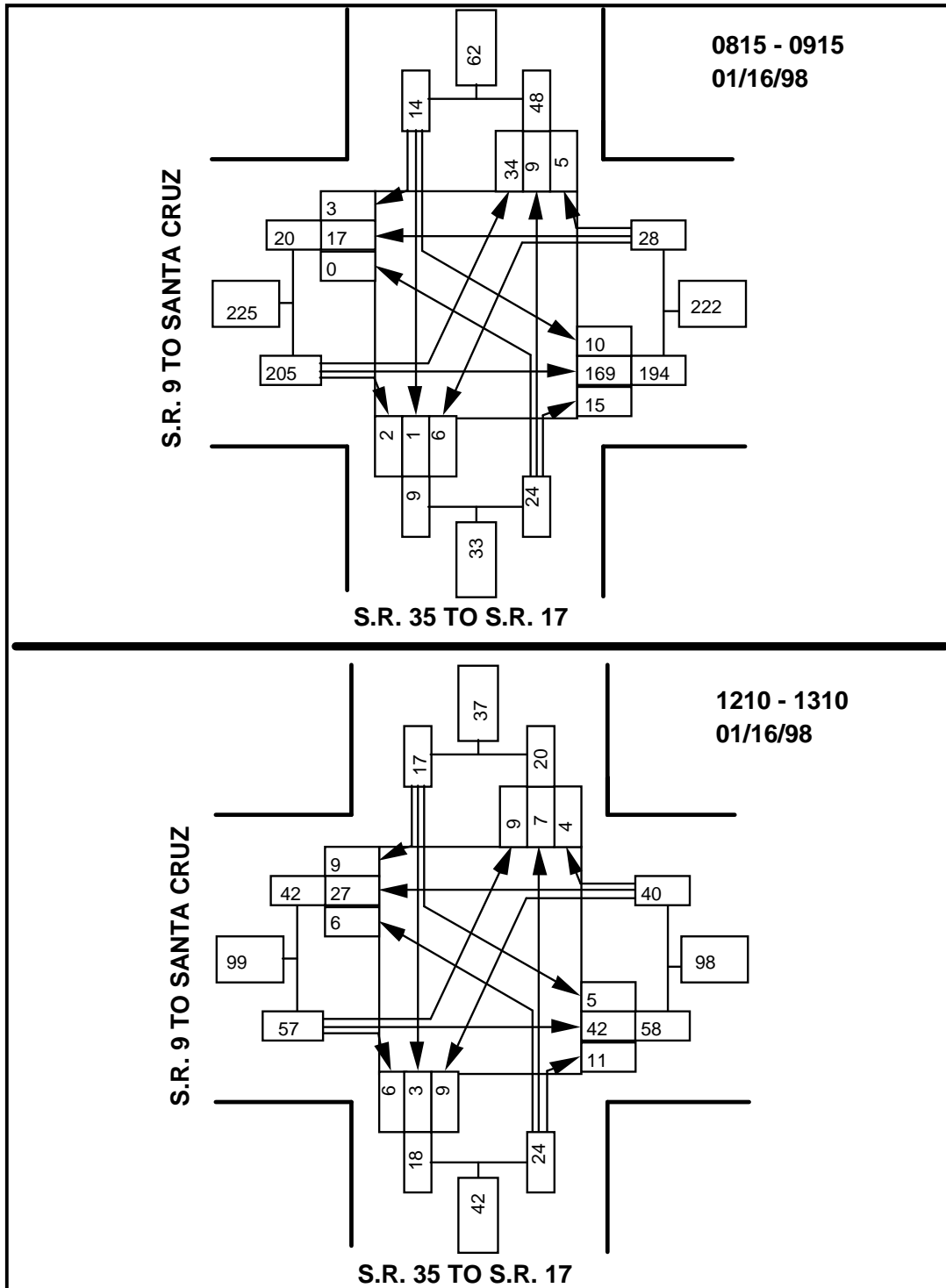

Figure 4

INTERSECTION FLOW



SIGNIFICANT ENVIRONMENTAL EFFECTS OF THE PROPOSED PROJECT

The purpose of this section is to identify impacts of the implementation of the general plan as a whole, and to identify impacts that have the potential for significance and will require more specific analyses when area development and management plans are prepared.

The thresholds are standards that the EIE uses to determine if an activity or project will or potentially have a significant impact. If the project or activity could exceed a threshold, a significant impact is designated. If mitigation can reduce the impact below the threshold, the impact is considered avoidable.

1. There is a potential for significant traffic impacts. The entrance to Partridge Farm may require a new alignment and channelization to provide safe access and egress when it is developed for public use. Assuming that each day use parking site generates 4 trips per day, 160 trips per day total could be generated by Partridge Farm development. Although the volume may not be excessive, sight limitations and the lack of acceleration/deceleration and left turn channelization lanes at the highway access may create problems. The current speed along State Highway 35 in the vicinity of Partridge Farm is 55 MPH.

The multi-agency visitor center proposal is conceptual, neither the capacity nor its location has been selected. The indicated location shown in the general plan is presented only as a possible alternative. The Department has included the multi-agency visitor center in the plan so that the California Park and Recreation Commission can approve the concept of this site as a possible candidate for future studies. The Department could at some future date jointly work with other agencies to study the feasibility. The development of a multi-agency visitor center at the northwest corner of the intersection of SR 9 and 35 could create significant traffic problems. Any objective determination of impact would be speculative.

THRESHOLD: Reduction in level of service below C or development of access with inadequate sight distance.

IMPACT: Potentially Significant.

IMPACT UNAVOIDABLE: No

2. The potential for significant visual impacts from development at the Partridge Farm does exist. The landscape has been considerably altered over the years by farm operations; however, a natural-appearing landscape is slowly reestablishing itself. The development of day-use parking could create an adverse visual impact to users. A parking area with reflective parked automobiles could be a very obvious human imposed intrusion to the landscape. The activity and equipment associated with the hike-in campsites could also be an intrusion to the visual landscape for park users. The area is not readily visible from the highway or by neighboring land owners.

THRESHOLD: New development in a natural-appearing landscape visible to users, neighbors, or adjacent traffic.

IMPACT: Potentially significant.

IMPACT UNAVOIDABLE: No

3. Five state or federal listed animal species occur, have suitable habitat, or have been observed in transit through the park. Prescribed burning, disturbance of roosting sites by public use, etc. have the possibility of impacting these species. Release of sediment from either of the two existing reservoirs catastrophically or as part of a resource management project could reduce steelhead trout spawning habitat in the San Lorenzo River. Trail crossings of the river can further degrade riparian and aquatic habitat.

SPECIES	LISTING	COMMENTS
steelhead trout	FT	Spawns in the upper San Lorenzo River within the park
California red-legged frog	FT	Potentially found in San Lorenzo River
American peregrine falcon	FE, SE	Suitable nesting habitat, observed flying over the park
marbled murrelet	FT, SE	Suitable nesting habitat, observed flying over the park
willow flycatcher	SE	Migrant through park

(FE = Federally listed endangered; FT = Federally listed threatened; SE = State listed endangered)

Of the approximately 575 acres of redwood wildlife habitat, about 350 acres or 60% is within the proposed natural preserve. However, only the old growth redwood is critical to the marbled murrelet. The only stand of ancient redwood is in the Kings Creek Canyon and entirely within the proposed natural preserve. No change in use is proposed for the remainder outside the proposed natural preserve. The natural preserve classification provides additional direction for resource management and restriction on the type of use. The protection of listed sensitive species is the same under any of the classifications in the State Park System.

THRESHOLD: Direct take or removal of individuals of a sensitive species, reduction in area, or alteration or disturbance of critical habitat.

IMPACT: Potentially significant.

IMPACT UNAVOIDABLE: No.

4. Brewer's calandrinia is found in the Castle Rock Ridge area of the park. Its habitat is gravelly slopes, disturbed or burnt areas, and chaparral. Castle Rock Ridge is the most popular visitor destination area; therefore, incidental destruction of individuals is possible. The possible introduction of prescribed burning to the area may create

more suitable habitat for the species while reduction of unauthorized trails and revegetation of disturbed area may reduce habitat area. Because no specific areas are proposed for these activities, the real extent of impact cannot be projected.

THRESHOLD: Direct take or removal of individuals of a sensitive species, reduction in area, or alteration or disturbance of critical habitat.

IMPACT: Potentially significant.

IMPACT UNAVOIDABLE: No.

5. Two rare natural plant communities (as defined by Department of Fish and Game, Natural Diversity Data Bank) occur within the park: knobcone pine forest and white alder riparian forest.

The knobcone pine is dependent on fire for reproduction; fire prepares the seed bed, releases minerals to the soil, removes vegetative cover, and opens the cones releasing the seeds. Approximately 40% of the existing knobcone forest would be outside of the proposed natural preserve. However, no change in public use is proposed for this area outside of the proposed natural preserve although it may receive incidental use from the nearby campground. Fire suppression in the unit has probably reduced the acreage of this community and will continue to do so, unless prescribed fire is introduced as a vegetative management activity. The white alder riparian forest along Kings Creek is entirely within the proposed natural preserve.

THRESHOLD: Reduction or loss of rare natural plant community.

IMPACT: Potentially significant.

IMPACT UNAVOIDABLE: No.

6. There is the potential for impacts to unknown cultural resources. The entire unit has not been surveyed for archeological or historical resources. Of particular concern are those areas currently receiving intensive use such as the Castle Rock Ridge area and other climbing areas. There is a potential for prehistoric "rock art" and rock shelter sites to be found on the rock faces and caverns of the Vaqueros Formation. There is a potential for intentional or accidental destruction of the art by climbing activities, vandalism, or foot traffic erosion.

THRESHOLD: Loss or destruction of resource

IMPACT: Potentially significant.

IMPACT UNAVOIDABLE: No.

MITIGATION MEASURES

The mitigation measures below reflect the specificity of a general plan and, therefore, are in the form of guidelines and directions. As management plans, area development

plans, or other projects are proposed, they will be subject to further environmental review and project-specific mitigation measures will be developed and implemented.

1. Prior to site specific development or preparation of management plans, areas of potential impact will be reviewed by Departmental historians and archeologists to determine the presence and significance of cultural resources, the potential impact, and recommended mitigation, if appropriate. The alteration or removal of any historic or archeological features will be subject to PRC 5024.5 review requirements. The evaluation is reviewed by the Departmental coordinator and also by the Office of Historic Preservation, if impact to a National Register-eligible site is possible.

Responsibility: Department Historian/Archeologist
 Monitoring/Reporting: An evaluation required under PRC 5024.5 is submitted by Departmental historians or archeologist to the Office of Historic Preservation for their concurrence.

2. Visual impacts can be mitigated by careful siting, design, and selection of materials. Landscaping with native plant species in the Partridge Farm area could screen developed parking areas and walk-in campsites.

Responsibility: Project manager, Department of Parks and Recreation
 Monitoring/Reporting: Project review required as part of the second tier CEQA process.

3. Prior to construction of facilities and trails, areas of potential impact will be surveyed for the presence of the endangered or threatened animal species. If there is a potential for impact, the California Department of Fish and Game and the U.S. Fish and Wildlife Service will be consulted. Facilities or trails will be relocated to avoid impact. Nesting or spawning periods can be avoided with proper scheduling of construction or resource management activities.

Responsibility: Department Staff/Resource Ecologist
 Monitoring/Reporting: Project review required as part of the second tier CEQA process.

4. Prior to any habitat restoration or construction, the areas will be surveyed for the presence of listed plant species. If any are found in the proposed area of construction or habitat restoration, the Department will consult with the U.S. Fish and Wildlife Service and the California Department of Fish and Game to incorporate protective measures or redesign the project to avoid impact.

Responsibility: Department Staff/Resource Ecologist

Monitoring/Reporting: Project review required as part of the second tier CEQA process.

5. The Department will consult with the Caltrans for the design requirements for providing safe access and egress at Partridge Farm. Left turn channelization and right turn acceleration and deceleration lanes may be necessary.

Responsibility: Project manager, Department of Parks and Recreation

Monitoring/reporting: Project review required as part of the second tier CEQA process. Conformance with Caltrans standards or recommendations will be considered meeting minimum requirements.

ENVIRONMENTAL EFFECTS THAT CANNOT BE AVOIDED IF THE PROJECT IS IMPLEMENTED

There is the potential for significant adverse environmental impacts resulting from increased public use and the development of facilities. These impacts, however, can be mitigated to a level of non-significance with proper design and siting of facilities, resource management programs, and specific mitigation measures.

The knobcone pine forest may continue to decline in acreage and vigor unless prescribed burning is implemented to provide the conditions necessary for its survival and expansion.

The impacts associated with climbing (i.e. soil erosion and compaction, vegetation loss around climbing sites, removal of moss from rock surfaces, development of "volunteer" trails, rock face exfoliations, disturbance of wildlife) may continue in those areas outside of the natural preserve (if classified).

ALTERNATIVES TO THE PROPOSED PROJECT

Four alternatives are proposed for comparison to the proposed project: (1) Preservation Priority, (2) Recreation Priority, (3) Wilderness Classification Alternative, and (4) No Project (CEQA requires the consideration of a No Project alternative - no change in existing development, operation, and management). It is possible to combine elements from each of the alternatives to create additional alternatives. Suitable alternative locations (acreage and slope restrictions) to public access development at Partridge Farm were not found within the existing park boundaries. A visitor center alternative location was considered at the Caltrans maintenance yard, but was rejected for the excessive traffic it would create at the entrance road to the Indian Rock subdivision.

The multi-agency visitor center proposal is conceptual and will require additional coordination with the other land management agencies and a feasibility study to determine the need, the size, and the best location.

For comparison between the alternatives and the proposed plan, a theoretical maximum daily use is estimated. The theoretical maximum daily use is calculated by multiplying three variables: (1) number of parking spaces, (2) number of people per vehicle, and (3) number of turnovers per parking space. The resulting number represents a theoretical or potential visitor use per day. The theoretical maximum daily use should be used only as an index or an order of magnitude for comparison between alternatives, the proposed plan, and the existing condition.

The following evaluation has included a worst case scenario that anticipates all users of all the parking bordering the highway will access Castle Rock State Park. In reality, many of the roadside parking spaces can be and are used for access to other areas such as Sanborn-Skyline County Park or Saratoga Gap Open Space Preserve or may simply be used as overlooks (such as Sempervirens Point). These calculations also assume that all the parking at the Castle Rock main parking lot is used only for day use, though some is used for the trail camp. Using these assumptions, the “no project” alternative (existing condition) has a theoretical maximum of 2018 visitors per day. However, actual visitor attendance records show an average of about 5300 visitors per month (1983 - 1993).

Proposed Project:

Existing roadside parking (Semp. Pt. reduced by 9 cars):	375 cars
Reduce roadside parking along SR35:	- 52 cars
Maintain Castle Rock Main parking lot:	+ 55 cars
Develop day use parking at Partridge Farm:	<u>+ 50 cars</u>
Total Day Use Parking:	428 cars

Maximum daily use for the proposed project, assuming 428 day use parking sites, 2 turnovers per parking site and 2.3 visitors per vehicle, 40 people per bus (1 site at Sempervirens Point),

$$(428 \times 2 \times 2.3) + 40 = 2009 \text{ visitors/day}$$

The theoretical maximum daily use for the proposed project is 2009 visitors/day.

(1) Preservation Priority Alternative

DESCRIPTION

The park administrative function would be relocated from the existing campground to Partridge Farm, Tin Can Ranch, or the Caltrans maintenance yard, if surplus. No public use facilities would be constructed at Partridge Farm or the Caltrans site. No

new trails would be constructed unless determined to be necessary. Volunteer trails would be removed and either scarified and revegetated, or allowed to return to a natural state unassisted. The 1800 acres proposed for classification as a natural preserve could be expanded to the west to include an additional 400 acres bounded by the Saratoga Toll Road, the southern boundary of the Indian Rock subdivision, Saratoga Gap Trail, and the San Lorenzo River. This would include all the redwood wildlife habitat within the proposed natural preserve as well as riverine and riparian habitat necessary for aquatic species such as steelhead trout and California red-legged frogs. Rock climbing, horseback riding, and mountain biking would be prohibited. Following the preparation of resource management plans, habitat restoration projects would be carried out to enhance the natural resource qualities. The Castle Rock campground could be removed.

Parking could be reduced at the existing parking area to decrease public access and use of the already heavily-used Castle Rock Ridge area. Roadside parking could be improved, but not increased elsewhere, to encourage dispersed use of the park. Five areas along State Highway 9 have potential for parking improvements: Waterman Gap, Red Mountain, Oil Creek, Beekhuis Road, and Hoe Gate. All of these parking areas are existing; while improvements could be achieved, it is not likely that any significant increase in capacity can be made. Most of these parking areas are highway turnouts or pull-offs. Some roadside parking areas could be eliminated to reduce the number of trail users and related impacts on adjacent resources. A parking survey was performed to determine the number of parking sites available for users of the state park. A total of 288 parking spaces were found along State Highway 9 between Saratoga Gap and Waterman Gap. Improved public use facilities previously planned at Sempervirens Point will reduce parking capacity from 30 to 21 vehicles and one bus. A total of 96 sites were found along Highway 35 between Saratoga Gap and Indian Rock. The existing Castle Rock parking area has 55 parking sites; it could be reduced to 35 sites. Reduction of the number of sites at the main Castle Rock parking lot cannot be replaced by expansion of these other parking areas around the perimeter of the park. Parking outside of the Castle Rock main lot plus parking at Indian Rock could be removed (52 sites).

Preservation Priority:

Existing roadside parking (Semp. Pt. reduced by 9 cars):	375 cars
Reduce roadside parking along SR35:	- 52 cars
Castle Rock Main parking lot (Reduce by 20 cars):	<u>+ 35 cars</u>
Total Day Use Parking:	358 cars

Maximum daily use, assuming 358 day use parking sites, 2 turnovers per parking site and 2.3 visitors per vehicle, 40 people per bus (1 site at Sempervirens Point):
 $(358 \times 2 \times 2.3) + 40 = 1687$ visitors/day

The theoretical maximum daily use for the preservation priority alternative is 1687 visitors/day.

EVALUATION

Rock climbing and camping opportunities would be lost. Soil erosion and vegetation loss around high use climbing areas and from volunteer trails would be reduced. Maximum recreational use would be limited by parking. Recreational use patterns may change; use may become more evenly distributed throughout the week and seasons, and dispersed around the park. Recreational demand will continue to increase with the population growth in the nearby urban areas. Although it is not expected that the state park must accommodate demand created by population growth, there will be increased use of the unit. Other open space areas in the region may need to allow for more public access to meet the growth demand. The expansion of the proposed natural preserve would include the powerline running west of the San Lorenzo River. Maintenance activities for the powerline would be incompatible with the natural preserve classification. Multiple entry points to the unit can create management and operational difficulties:

1. Visitor contact would be restricted thereby reducing the opportunity to educate the visitor to the sensitive resources, the need for protection, and recognition of entering a State Park.
2. Potential control of illegal activities would be reduced.
3. Emergency response time would be increased.
4. Maintenance costs would be increased.
5. The demand for water and sanitation facilities at parking areas would be unsatisfied.

Multiple entries may disperse users over a larger area but would substantially reduce the opportunity for park staff to contact and monitor use activities. Rotating closures could allow areas to recuperate from intensive use, if necessary.

(2) Recreation Priority Alternative

DESCRIPTION

Partridge Farm would be developed to its potential. Allowing a 1000' buffer from the highway, the remaining 36 acres could be developed to 150 standard campsites, and 50 day use parking sites. The natural preserve would be limited to the Kings Creek watershed, encompassing the ancient redwood stand, to allow the broadest range of recreation use. The Department would negotiate with Santa Cruz County and San Lorenzo Water District to amend the easement for the Saratoga Toll Road to permit mountain bike usage. Kings Creek Truck Trail could be opened to mountain bike use with an agreement by the Water District and private property owners. Climbing would

be limited to low impact climbing but not limited to any area. Lions Cave Area would be opened to the public without a natural preserve classification. New trails and trail camps would be developed to improve visitor access to all areas of the park.

Recreation Priority:

Existing roadside parking (Semp. Pt. reduced by 9 cars):	375 cars
Maintain Castle Rock main parking lot:	+ 55 cars
Develop day use parking at Partridge Farm:	<u>+ 50 cars</u>
Total Day Use Parking:	480 cars

Maximum daily use, assuming 480 day use parking sites, 2 turnovers per day use parking site, 2.3 visitors per day use vehicle, 150 camp sites, 3.5 visitors per vehicle at a regular campsite, and 40 visitors per bus (1 site at Sempervirens Point):

$$(480 \times 2 \times 2.3) + (150 \times 3.5) + 40 = 2773 \text{ visitors/day}$$

The theoretical maximum daily use for the recreation priority alternative is 2773 visitors/day.

EVALUATION

Generally, the impacts would be those resulting from increased public use. Soil erosion and vegetation loss would continue and increase around the highly popular Castle Rock Ridge area. The Lion Caves area would suffer the most visible impacts as it has been relatively unused by the visiting public. Unrestricted use of the Lion Caves area would eliminate its potential use as a baseline or control for future studies of user impacts, and its value as wildlife habitat.

Increasing the camping capacity at Partridge Farm from 20 to 150 campsites could increase the water supply requirement to nearly 12,000 gallons per day at maximum capacity. Intensive camping development would likely render the site undesirable for amateur astronomical use.

Mountain bike usage would require trail planning and management that may designate some trails as single use, one way use, or multiple use to reduce conflicts of oncoming traffic and reduce confrontation with other trail users. Acquisition of rights-of-way or easements on Kings Creek Truck Trail would be required as most of the road is not in State Park ownership. The concentration of use at Partridge Farm could alleviate some of the operation and management difficulties resulting from multiple entry points to the unit. An increase in use would create additional demands for maintenance and operation service while the concentration of use could provide some economies.

(3) Wilderness Classification Alternative

DESCRIPTION

All undeveloped areas of the Castle Rock State Park could be classified by the California Park and Recreation Commission as a State Wilderness. Tin Can Ranch, the main parking lot, Sempervirens Point, a buffer zone along the highways, and Partridge Farm area would be excluded from the state wilderness classification. The existing campground could be removed to provide the maximum area for wilderness. The park administrative function could be moved to Tin Can Ranch, Partridge Farm, or the Caltrans yard, if surplus. The primary visitor contact point would be the main parking lot. Primitive, back-country campsites could be provided. Mountain biking, as a mechanized transport, would be prohibited. Climbing would be permitted subject to the conditions of a climbing management plan.

Wilderness Classification:

Existing roadside parking (Semp. Pt. reduced by 9 cars):	375 cars
Maintain Castle Rock Main parking lot:	<u>+ 55 cars</u>
Total Day Use Parking:	430 cars

Maximum daily use, assuming 430 parking sites, 2 turnovers per day use parking site, and 2.3 visitors per vehicles, and one bus site (40 passengers):

$$(430 \times 2 \times 2.3) + 40 = 2018 \text{ visitors/day}$$

The theoretical maximum daily use for the wilderness classification alternative is 2018 visitors/day.

EVALUATION

Castle Rock State Park does not meet all the legal requirements of the State Wilderness classification. There are four conditions: (1) appears generally to have been affected primarily by the forces of nature, with the imprint of man's work substantially unnoticeable; (2) has outstanding opportunities for solitude or a primitive and unconfined type of recreation; (3) has at least 5,000 acres of land, either by itself or in combination with contiguous areas possessing wilderness characteristics, or is of sufficient size as to make practical its preservation and use in an unimpaired condition; and (4) may also contain ecological, geological, or other features of scientific, educational, scenic, or historical value. The park meets the fourth and partially the second conditions. The first and third conditions are debatable. Much of the area of the park has been historically impacted by logging and agriculture, and a high voltage power line runs down the San Lorenzo River valley, through the middle of the potential wilderness area. There is an easement for access for the maintenance of the power lines and the corridor, which is inappropriate for the wilderness classification. While

much of the "imprint of man's work" is not readily apparent, ecologically the evidence remains and in some cases, the physical evidence (i.e. Saratoga Toll Road, power lines) remains. The entire park area is less than the 5,000 acres minimum and the adjacent highways and private properties prevent the combination with contiguous properties except for the San Lorenzo Valley Water District lands to the south. However, the eventual use of these District lands is unknown.

The existing camping opportunities would be lost; back-country camping opportunities could be increased. Camping in nonspecific sites could adversely impact special plants and wildlife habitat. Restriction on the use of motorized vehicles in wilderness areas would severely restrict the possibility of prescribed burning and, therefore, increase fuel load build-up and fire hazard. Further, restriction of motorized vehicles in the wilderness areas would allow deterioration of existing roads which would inhibit emergency (fire and rescue) vehicle use. Resource management activities would be limited; natural processes would generally be allowed to continue without human intervention. Cultural features, such as historic cabin sites, old logging roads, historic orchards, and the Toll Road would be left to deteriorate by natural processes. Depending on the occurrence of wildfire, the lack of prescribed burning within the state wilderness could further inhibit the reproduction of the knobcone pine.

(4) No Project Alternative

DESCRIPTION

No new facilities would be constructed. The unit office could be moved to either Tin Can Ranch, Partridge Farm, or the Caltrans maintenance yard, if surplus. A climbing plan would be developed in cooperation with the climbing community, which would determine the appropriate climbing areas and restrictions. Partridge Farm would be allowed to recover naturally. No natural preserve classification would be proposed.

Maximum daily use, assuming 430 parking sites, 2 turnovers per day use parking site, and 2.3 visitors per vehicle, and one bus site (40 passengers):

$$(430 \times 2 \times 2.3) + 40 = 2018 \text{ visitors/day}$$

The theoretical maximum daily use for the no project alternative is 2018 visitors/day.

EVALUATION

The eventual failure of the small reservoirs at Tin Can Ranch and Partridge Farm could introduce a significant short-term sediment load to the San Lorenzo River adversely affecting the fishery and aquatic habitat quality.

Public demand for access will increase with population growth. Without provision for use areas appropriately designed and placed to provide the visitor with some sense of

organization or control and resource awareness, the significant park values will be irreparably degraded (i.e. "volunteer" trails, new climbing routes, etc. will accelerate soil erosion, vegetation loss, and disturbance of wildlife habitat).

SIGNIFICANT IRREVERSIBLE ENVIRONMENTAL CHANGES IF THE PROJECT IS IMPLEMENTED

No significant irreversible environmental changes are projected. While any facility development may be considered a long-term commitment of resources, the impacts can be reversed through removal of the facilities and discontinued use. Much of the Castle Rock area was logged and has recovered. The Department does remove or realign trails, replace campsites, etc. where the impact has become unacceptable either from excessive use or from a change in environmental circumstances.

GROWTH INDUCING IMPACT OF THE PROPOSED PROJECT

The proposed project may have a minor cumulative impact on growth inducement in the area. Any improvement or increase in capacity can encourage increased use which translates into additional tourism and its attendant demand for services; however, population growth in the nearby urban area will create the demand for recreational opportunities and increased use with or without facility development at Castle Rock State Park. The proposed project would increase the theoretical maximum daily use by only 2.5%. That 2.5% represents the increase from the camping at Partridge Farm. There is no proposed increase in day use parking capacity.

There are no known development projects proposed in the immediate vicinity of the unit. Caltrans has closed the maintenance station at Saratoga Gap and is considering surplusing the property. San Lorenzo Valley Water District, a major land owner to the south of the unit, is reviewing its options for management and use of those lands. Midpeninsula Regional Open Space District has recently started a planning effort for their lands in the vicinity of Castle Rock State Park, but at this time, we are unaware of project proposals that would change land use in the immediate proximity of the park.

EFFECTS FOUND NOT TO BE SIGNIFICANT

In this first tier of planning and environmental analysis, the following impacts were found not significant. In future planning and environmental analysis, they will be reconsidered.

1. No significant noise impacts by future development or management potential allowed for in this general plan were projected. There will be temporary noise increases during future construction; however, there are no immediate sensitive receptors. Construction normally would be limited to regular working hours.

2. No significant impact to archeological resources is projected. No sites are known to be located within any area proposed for development. The only known archeological site is in the Partridge Farm area, and no development is proposed that would impact the site. There is a potential for “rock art” and rock shelter sites in the climbing areas. These areas will be surveyed in preparation of the climbing management plan. Known historic resource impacts are similarly limited. The Partridge Farm house will be maintained in its current or adaptive use and condition. It could be converted to the unit administrative office with no impact to its historic integrity. The Saratoga Toll Road will continue in its present use as a recreational trail. Other historic features may be provided with interpretive panels.
3. Assuming maximum buildout and full occupancy (worst case scenario) of the proposed project (every day use parking site used twice a day, each vehicle carries 2.3 people and each person uses 5 gallons of water) the maximum total demand for Partridge Farm would be approximately 1150 gallons per day or a flow of .0016 cubic feet per second. Low flush toilets, and low flow faucets can be installed to further reduce the water supply requirements. If water is supplied to the existing Castle Rock parking lot, an additional 1265 gallons could be required for a combined total of 3450 gallons per day or 2.4 gallons per minute. The water system at Partridge Farm consists of a 10,000 gallon tank, well, and 20 GPM pump. The well and pump have been tested for several days with no significant draw down. Therefore, there is a more than adequate water supply for the proposed development.
4. Soil erosion is not expected to increase. The proposed development at Partridge Farm is an area of lower erosion potential. The plan provides for consideration of new trails (projected at less than 10 miles). However, parking capacity will not significantly change; therefore, intensity of use may decline as the number of users are spread over a longer distance of trails. A unitwide trails plan will be prepared which may call for the development of new trails and the removal of redundant trails. Trail construction and use will likely take place in areas of higher erosion hazard. Trails will be constructed to the standards of the Department’s Trails Construction Manual, and trail conditions will be monitored by staff and volunteers. Resource management plans may call for the elimination or consolidation of “volunteer” trails, which could result in the reduction of soil erosion.
5. While the area of Castle Rock State Park is relatively geologically active (known active faults, known rock slide avalanches, high potential for mass movement by virtue of the steep slopes and high water table), the General Plan does not call for development or substantial increase of public use in known risk areas. A landslide map has been prepared and will be maintained as part of the Resource Inventory in the Unit Data File. The entire unit is subject to significant seismic movements; however, the change in risk (increased or decreased) is dependent on where the

visitor might be if they were not at Castle Rock State Park. The impact is not considered significant.

6. No change in public use, and, therefore, no change in fire risk is expected in the area immediately downslope from the Indian Rock Ranch subdivision. The reintroduction of fire by prescribed burning will reduce the fuel loading; it is unknown at this time whether the prescribed burning will take place in areas that will benefit the subdivision. The fire risk will increase at Partridge Farm if it is opened to regular public use. The increased risk is partially mitigated by its close proximity to the highway, employee residence and potential supervision, the top of the ridge location with low slope angles, and the preparation of a unit wildfire management plan.

REFERENCES

1992 Traffic Volumes on California State Highways, California Department of Transportation.

Partridge Farm - Boisseranc Unit, Castle Rock State Park, Resources Description and Guidelines for Restoration, Harvey and Stanley Associates for Sempervirens Fund and the Department of Parks and Recreation, 1984.

Natural Resources Inventory of Castle Rock State Park and the Upper San Lorenzo River Basin, Harvey and Stanley Associates for Sempervirens Fund, 1979.

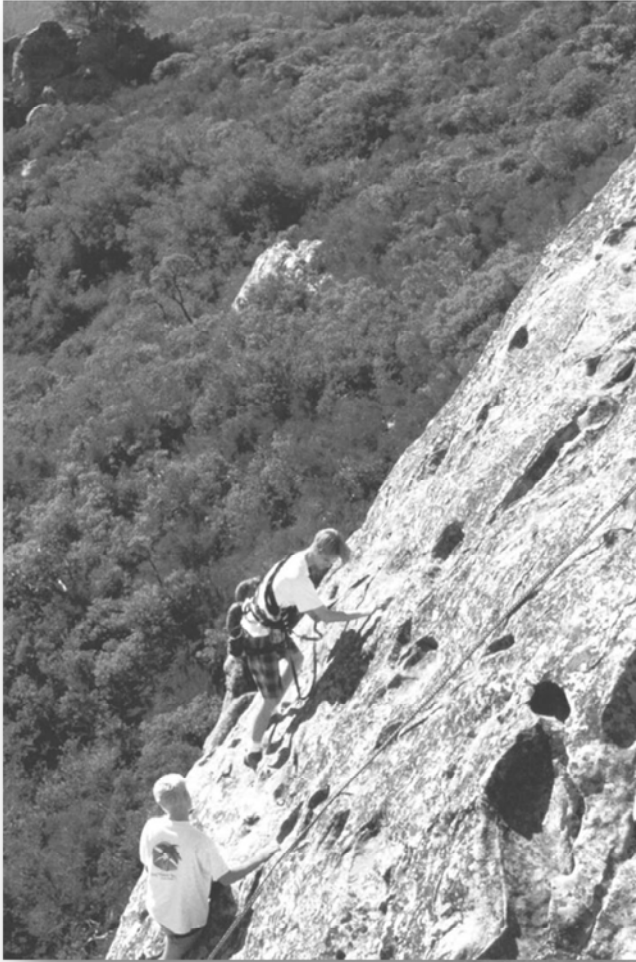

APPENDICES

Blank side of divider page

Appendix A

Partial Plant Species List of Castle Rock State Park *

Family	Species	Common Name	Origin
Blechnaceae	<i>Woodwardia fimbriata</i>	Giant chain fern	Native
Dryopteridaceae	<i>Dryopteris arguta</i>	Coastal wood fern	Native
Dryopteridaceae	<i>Polystichum munitum</i>	Western sword fern	Native
Pteridaceae	<i>Adiantum aleuticum</i>	Five-finger fern	Native
Pinaceae	<i>Pinus attenuata</i>	Knobcone pine	Native
Pinaceae	<i>Pinus coulteri</i>	Coulter pine	Introduced
Pinaceae	<i>Pinus ponderosa</i>	Ponderosa pine	Introduced
Pinaceae	<i>Pseudotsuga menziesii var. menziesii</i>	Douglas-fir	Native
Taxaceae	<i>Torreya californica</i>	California nutmeg	Native
Taxodiaceae	<i>Sequoia sempervirens</i>	Redwood	Native
Aceraceae	<i>Acer macrophyllum</i>	Big-leaf maple	Native
Anacardiaceae	<i>Toxicodendron diversilobum</i>	Poison oak	Native
Apocynaceae	<i>Vinca major</i>	Periwinkle	Introduced
Aristolochiaceae	<i>Asarum caudatum</i>	Wild ginger	Native
Asteraceae	<i>Carduus pycnocephalus</i>	Italian thistle	Introduced
Asteraceae	<i>Centaurea solstitialis</i>	Yellow star-thistle	Introduced
Asteraceae	<i>Hypochaeris glabra</i>	Smooth cat's ear	Introduced
Betulaceae	<i>Alnus rhombifolia</i>	White alder	Native
Betulaceae	<i>Corylus cornuta var. californica</i>	California hazelnut	Native
Caprifoliaceae	<i>Lonicera hispidula var. vacillans</i>	Hairy honeysuckle	Native
Caprifoliaceae	<i>Symphoricarpos albus var. laevigatus</i>	Snowberry	Native
Caryophyllaceae	<i>Cerastium glomeratum</i>	Mouse-ear chickweed	Introduced
Ericaceae	<i>Arbutus menziesii</i>	Pacific madrone	Native
Ericaceae	<i>Arctostaphylos tomentosa ssp. crustacea</i>	Brittle-leaved manzanita	Native
Fabaceae	<i>Genista monspessulana</i>	French broom	Introduced
Fabaceae	<i>Lupinus hirsutissimus</i>	Stinging lupine	Native
Fabaceae	<i>Pickeringia montana var. montana</i>	Chaparral pea	Native
Fabaceae	<i>Vicia sativa</i>	Spring vetch	Introduced
Fagaceae	<i>Lithocarpus densiflorus</i>	Tanbark oak	Native
Fagaceae	<i>Quercus chrysolepis</i>	Canyon live oak	Native
Fagaceae	<i>Quercus kelloggii</i>	California black oak	Native
Fagaceae	<i>Quercus wislizenii</i>	Interior live oak	Native
Garryaceae	<i>Garrya elliptica</i>	Coast silk tassel	Native
Geraniaceae	<i>Erodium cicutarium</i>	Red-stemmed filaree	Introduced
Hydrophyllaceae	<i>Emmenanthe penduliflora</i>	Whispering bells	Native
Hydrophyllaceae	<i>Eriodictyon californicum</i>	Yerba santa	Native
Hydrophyllaceae	<i>Nemophila menziesii var. menziesii</i>	Baby blue-eyes	Native

Partial Plant Species List (continued)

Family	Species	Common Name	Origin
Lamiaceae	<i>Salvia mellifera</i>	Black sage	Native
Lauraceae	<i>Umbellularia californica</i>	California bay	Native
Oleaceae	<i>Fraxinus latifolia</i>	Oregon ash	Native
Oxalidaceae	<i>Oxalis oregana</i>	Redwood sorrel	Native
Papaveraceae	<i>Dendromecon rigida</i>	Bush poppy	Native
Polemoniaceae	<i>Navarretia squarrosa</i>	Skunkweed	Native
Portulacaceae	<i>Calandrinia breweri</i>	Brewer's calandrinia	Native **
Portulacaceae	<i>Montia parvifolia</i>	Small-leaved montia	Native
Ranunculaceae	<i>Ranunculus californicus</i>	California buttercup	Native
Rhamnaceae	<i>Ceanothus cuneatus</i> var. <i>cuneatus</i>	Buck brush	Native
Rhamnaceae	<i>Ceanothus papillosus</i> var. <i>papillosus</i>	Warty-leaved ceanothus	Native
Rosaceae	<i>Adenostoma fasciculatum</i>	Chamise	Native
Rosaceae	<i>Heteromeles arbutifolia</i>	Toyon	Native
Scrophulariaceae	<i>Castilleja foliolosa</i>	Woolly Indian paintbrush	Native
Scrophulariaceae	<i>Mimulus aurantiacus</i>	Bush monkey flower	Native
Scrophulariaceae	<i>Mimulus cardinalis</i>	Scarlet monkey flower	Native
Violaceae	<i>Viola sempervirens</i>	Redwood violet	Native
Liliaceae	<i>Calochortus albus</i>	White globe lily, fairy lantern	Native
Liliaceae	<i>Chlorogalum pomeridianum</i>	Soap plant	Native
Liliaceae	<i>Dichelostemma capitatum</i> ssp. <i>capitatum</i>	Blue dicks	Native
Liliaceae	<i>Disporum hookeri</i>	Fairy bells	Native
Liliaceae	<i>Smilacina stellata</i>	False Solomon's seal	Native
Liliaceae	<i>Trillium chloropetalum</i>	Giant wake-robin	Native
Liliaceae	<i>Triteleia laxa</i>	Ithuriel's spear	Native
Poaceae	<i>Agrostis hallii</i>	Hall's bentgrass	Native
Poaceae	<i>Aira caryophyllea</i>	Silver European hairgrass	Introduced
Poaceae	<i>Bromus carinatus</i> var. <i>carinatus</i>	California brome	Native
Poaceae	<i>Bromus diandrus</i>	Ripgut grass	Introduced
Poaceae	<i>Bromus hordaceus</i>	Soft chess	Introduced
Poaceae	<i>Cynosurus echinatus</i>	Dogtail grass	Introduced
Poaceae	<i>Elymus glaucus</i>	Blue wildrye	Native

* Please note that a few species listed as introduced are native to California, but are not indigenous to Castle Rock State Park. A prime example is ponderosa pine, which is naturally restricted in the Santa Cruz Mountains to a soil type and microenvironment type not found in the park. Ponderosa pines occurring in the park were planted prior to state acquisition.

** Brewer's calandrinia (*Calandrinia breweri*) is a California Native Plant Society List 4 plant.

Appendix B

Animal Species List of Castle Rock State Park

Common Name	Scientific Name	Family Name
Tiger Salamander	<i>Ambystoma tigrinum</i>	Ambystomatidae
Pacific Giant Salamander	<i>Dicamptodon ensatus</i>	Ambystomatidae
Rough Skinned Newt	<i>Taricha granulosa</i>	Salamandridae
California Newt	<i>Taricha torosa</i>	Salamandridae
Ensatina	<i>Ensatina eschscholtzi</i>	Plethodontidae
California Slender Salamander	<i>Batrachoseps attenuatus</i>	Plethodontidae
Black Salamander	<i>Aneides flavipunctatus</i>	Plethodontidae
Arboreal Salamander	<i>Aneides lugubris</i>	Plethodontidae
Western Spadefoot	<i>Scaphiopus hammondi</i>	Pelobatidae
Red-legged Frog	<i>Rana aurora</i>	Ranidae
Foothill Yellow-legged Frog	<i>Rana boylei</i>	Ranidae
Western toad	<i>Bufo boreas</i>	Bufo
Pacific treefrog	<i>Hyla regilla</i>	Hylidae
Green heron	<i>Butorides virescens</i>	Ardeidae
Wood duck	<i>Aix sponsa</i>	Anatidae
Mallard	<i>Anas platyrhynchos</i>	Anatidae
Common merganser	<i>Mergus merganser</i>	Anatidae
Turkey vulture	<i>Cathartes aura</i>	Cathartidae
White-tailed kite	<i>Elanus caeruleus</i>	Accipitridae
Sharp-shinned hawk	<i>Accipiter striatus</i>	Accipitridae
Cooper's hawk	<i>Accipiter cooperii</i>	Accipitridae
Red-shouldered hawk	<i>Buteo lineatus</i>	Accipitridae
Red-tailed hawk	<i>Buteo jamaicensis</i>	Accipitridae
Rough-legged hawk	<i>Buteo lagopus</i>	Accipitridae
Golden eagle	<i>Aquila chrysaetos</i>	Accipitridae
American kestrel	<i>Falco sparverius</i>	Falconidae
Merlin	<i>Falco columbarius</i>	Falconidae
Peregrine falcon	<i>Falco peregrinus</i>	Falconidae
Prairie falcon	<i>Falco mexicanus</i>	Falconidae
Ring-necked pheasant	<i>Phasianus colchicus</i>	Phasianidae
California quail	<i>Callipepla californicus</i>	Phasianidae
Mountain quail	<i>Oreortyx pictus</i>	Phasianidae
Killdeer	<i>Charadrius vociferus</i>	Charadriidae
Spotted sandpiper	<i>Actitis macularia</i>	Scolopacidae
Ring-billed gull	<i>Larus delawarensis</i>	Laridae
California gull	<i>Larus californicus</i>	Laridae
Herring gull	<i>Larus argentatus</i>	Laridae
Marbled murrelet	<i>Brachyramphus marmoratus</i>	Alcidae
Rock dove	<i>Columba livia</i>	Columbidae
Band-tailed pigeon	<i>Columba fasciata</i>	Columbidae
Mourning dove	<i>Zenaidura macroura</i>	Columbidae
Greater roadrunner	<i>Geococcyx californianus</i>	Cuculidae
Common barn owl	<i>Tyto alba</i>	Tytonidae
Western screech owl	<i>Otus kennicottii</i>	Strigidae
Great horned owl	<i>Bubo virginianus</i>	Strigidae
Northern pygmy owl	<i>Glaucidium gnoma</i>	Strigidae
Burrowing owl	<i>Athene cunicularia</i>	Strigidae
Spotted owl	<i>Strix occidentalis</i>	Strigidae

Animal Species List (continued)

Common Name	Scientific Name	Family Name
Long-eared owl	<i>Asio otus</i>	Stigidae
Northern saw-whet owl	<i>Aegolius acadicus</i>	Strigidae
Common poorwill	<i>Phalaenoptilus nuttallii</i>	Caprimulgidae
Black swift	<i>Cypseloides niger</i>	Apodidae
Vaux's swift	<i>Chaetura vauxi</i>	Apodidae
White-throated swift	<i>Aeronautes saxatalis</i>	Apodidae
Anna's hummingbird	<i>Calypte anna</i>	Trochilidae
Rufous hummingbird	<i>Selasphorus rufus</i>	Trochilidae
Allen's hummingbird	<i>Selasphorus sasin</i>	Trochilidae
Belted kingfisher	<i>Ceryle alcyon</i>	Alcedinidae
Lewis' woodpecker	<i>Melanerpes lewis</i>	Picidae
Acorn woodpecker	<i>Melanerpes formicivorus</i>	Picidae
Yellow-bellied sapsucker	<i>Sphyrapicus varius</i>	Picidae
Nuttall's woodpecker	<i>Picoides nuttallii</i>	Picidae
Downy woodpecker	<i>Picoides pubescens</i>	Picidae
Hairy woodpecker	<i>Picoides villosus</i>	Picidae
Common flicker	<i>Colaptes auratus</i>	Picidae
Pileated woodpecker	<i>Dryocopus pileatus</i>	Picidae
Olive-sided flycatcher	<i>Contopus borealis</i>	Tyrannidae
Western wood-peewee	<i>Contopus sordidulus</i>	Tyrannidae
Willow flycatcher	<i>Empidonax traillii</i>	Tyrannidae
Pacific-slope flycatcher	<i>Empidonax difficilis</i>	Tyrannidae
Black phoebe	<i>Sayornis nigricans</i>	Tyrannidae
Say's phoebe	<i>Sayornis saya</i>	Tyrannidae
Ash-throated flycatcher	<i>Myiarchus cinerascens</i>	Tyrannidae
Western kingbird	<i>Tyrannus verticalis</i>	Tyrannidae
Horned lark	<i>Eremophila alpestris</i>	Alaudidae
Purple martin	<i>Progne subis</i>	Hirundinidae
Tree swallow	<i>Tachycineta bicolor</i>	Hirundinidae
Violet-green swallow	<i>Tachycineta thalassina</i>	Hirundinidae
Northern rough-winged swallow	<i>Stelgidopteryx serripennis</i>	Hirundinidae
Barn swallow	<i>Hirundo rustica</i>	Hirundinidae
Steller's jay	<i>Cyanocitta stelleri</i>	Corvidae
Scrub jay	<i>Aphelocoma coerulescens</i>	Corvidae
Clark's nutcracker	<i>Nucifraga columbiana</i>	Corvidae
Yellow-billed magpie	<i>Pica nuttallii</i>	Corvidae
American crow	<i>Corvus brachyrhynchos</i>	Corvidae
Common raven	<i>Corvus corax</i>	Corvidae
Chestnut-backed chickadee	<i>Parus rufescens</i>	Paridae
Plain titmouse	<i>Parus inornatus</i>	Paridae
Bushtit	<i>Psaltriparus minimus</i>	Aegithalidae
Red-breasted nuthatch	<i>Sitta canadensis</i>	Sittidae
White-breasted nuthatch	<i>Sitta carolinensis</i>	Sittidae
Pygmy nuthatch	<i>Sitta pygmaea</i>	Sittidae
Brown creeper	<i>Certhia americana</i>	Certhidae
Rock wren	<i>Salpinctes obsoletus</i>	Troglodytidae
Canyon wren	<i>Catherpes mexicanus</i>	Troglodytidae
Bewick's wren	<i>Thryomanes bewickii</i>	Troglodytidae

Animal Species List (continued)

Common Name	Scientific Name	Family Name
House wren	<i>Troglodytes aedon</i>	Troglodytidae
Winter wren	<i>Troglodytes troglodytes</i>	Troglodytidae
American dipper	<i>Cinclus mexicanus</i>	Cinclidae
Golden-crowned kinglet	<i>Regulus satrapa</i>	Muscicapidae
Ruby-crowned kinglet	<i>Regulus calendula</i>	Muscicapidae
Blue-gray gnatcatcher	<i>Poliophtila caerulea</i>	Muscicapidae
Western bluebird	<i>Sialia mexican</i>	Muscicapidae
Townsend's solitaire	<i>Myadestes townsendi</i>	Muscicapidae
Swainson's thrush	<i>Catharus ustulatus</i>	Muscicapidae
Hermit thrush	<i>Catharus guttatus</i>	Muscicapidae
American robin	<i>Turdus migratorius</i>	Muscicapidae
Varied thrush	<i>Ixoreus naevius</i>	Muscicapidae
Wrentit	<i>Chamaea fasciata</i>	Muscicapidae
Northern mockingbird	<i>Mimus polyglottos</i>	Mimidae
California thrasher	<i>Toxostoma ridivivum</i>	Mimidae
Water pipit	<i>Anthus spinoletta</i>	Motacillidae
Cedar waxwing	<i>Bombycilla cedrorum</i>	Bombycillidae
Loggerhead shrike	<i>Lanius ludovicianus</i>	Laniidae
European starling	<i>Sturnus vulgaris</i>	Sturnidae
Solitary vireo	<i>Vireo solitarius</i>	Vireonidae
Hutton's vireo	<i>Vireo huttoni</i>	Vireonidae
Warbling vireo	<i>Vireo gilvus</i>	Vireonidae
Orange-crowned warbler	<i>Vermivora calata</i>	Emberizidae
Nashville warbler	<i>Vermivora celata</i>	Emberizidae
Yellow warbler	<i>Dendroica petechia</i>	Emberizidae
Yellow-rumped warbler	<i>Dendroica coronata</i>	Emberizidae
Black-throated gray warbler	<i>Dendroica nigrescens</i>	Emberizidae
Townsend's warbler	<i>Dendroica townsendi</i>	Emberizidae
Hermit warbler	<i>Dendroica occidentalis</i>	Emberizidae
Macgillivray's warbler	<i>Oporonis tolmiei</i>	Emberizidae
Common yellowthroat	<i>Geothlypis trichas</i>	Emberizidae
Wilson's warbler	<i>Wilsonia pusilla</i>	Emberizidae
Yellow-breasted chat	<i>Icteria virens</i>	Emberizidae
Western tanager	<i>Piranga ludoviciana</i>	Emberizidae
Black-headed grosbeak	<i>Pheucticus melanocephalus</i>	Emberizidae
Rose-breasted grosbeak	<i>Pheucticus ludovicianus</i>	Emberizidae
Lazuli bunting	<i>Passerina amoena</i>	Emberizidae
Rufous-sided towhee	<i>Pipilo erythrophthalmus</i>	Emberizidae
California towhee	<i>Pipilo fuscus</i>	Emberizidae
Rufous-crowned sparrow	<i>Aimophila ruficeps</i>	Emberizidae
Chipping sparrow	<i>Spizella passerina</i>	Emberizidae
Black-chinned sparrow	<i>Spizella atrogularis</i>	Emberizidae
Lark sparrow	<i>Chondestes grammacus</i>	Emberizidae
Sage sparrow	<i>Amphispiza belli</i>	Emberizidae
Savannah sparrow	<i>Passerculus sandwichensis</i>	Emberizidae
Grasshopper sparrow	<i>Ammodramus savannarum</i>	Emberizidae
Fox sparrow	<i>Passerella illaca</i>	Emberizidae
Song sparrow	<i>Melospiza melodia</i>	Emberizidae

Animal Species List (continued)

Common Name	Scientific Name	Family Name
Lincoln's sparrow	<i>Melospiza lincolnii</i>	Emberizidae
Golden-crowned sparrow	<i>Zonotrichia atricapilla</i>	Emberizidae
White-crowned sparrow	<i>Zonotrichia leucophrys</i>	Emberizidae
White-throated sparrow	<i>Zonotrichia albicollis</i>	Emberizidae
Dark-eyed junco	<i>Juco hyemalis</i>	Emberizidae
Red-winged blackbird	<i>Agelaius phoeniceus</i>	Emberizidae
Tri-colored blackbird	<i>Agelaius tricolor</i>	Emberizidae
Western meadowlark	<i>Sturnella neglecta</i>	Emberizidae
Brewer's blackbird	<i>Euphagus cyanocephalus</i>	Emberizidae
Brown-headed cowbird	<i>Molothrus ater</i>	Emberizidae
Northern oriole	<i>Icterus galbula</i>	Emberizidae
Purple finch	<i>Carpodacus mexicanus</i>	Fringillidae
House finch	<i>Carpodacus mexicanus</i>	Fringillidae
Red crossbill	<i>Loxia curvirostra</i>	Fringillidae
Pine siskin	<i>Carduelis pinus</i>	Fringillidae
Lesser goldfinch	<i>Carduelis psaltria</i>	Fringillidae
Lawrence's goldfinch	<i>Carduelis lawrencei</i>	Fringillidae
American goldfinch	<i>Carduelis tristis</i>	Fringillidae
Evening grosbeak	<i>Coccothraustes vespertinus</i>	Fringillidae
House sparrow	<i>Passer domesticus</i>	Passeridae
Virginia Opossum	<i>Didelphis marsupialis</i>	Didelphidae
Vagrant Shrew	<i>Sorex vagrans</i>	Soricidae
Ornate Shrew	<i>Sorex ornatus</i>	Soricidae
Trowbridge's Shrew	<i>Sorex trowbridgii</i>	Soricidae
Shrew-mole	<i>Neurotrichus gibbsii</i>	Talpidae
Broad-footed Mole	<i>Scapanus latimanus</i>	Talpidae
Little Brown Myotis	<i>Myotis lucifugus</i>	Vespertilionidae
Yuma Myotis	<i>Myotis yumanensis</i>	Vespertilionidae
Long-eared Myotis	<i>Myotis evotis</i>	Vespertilionidae
Fringed Myotis	<i>Myotis thysanodes</i>	Vespertilionidae
Long-legged Myotis	<i>Myotis volans</i>	Vespertilionidae
California Myotis	<i>Myotis californicus</i>	Vespertilionidae
Western Pipistrelle	<i>Pipistrellus hesperus</i>	Vespertilionidae
Big Brown Bat	<i>Eptesicus fuscus</i>	Vespertilionidae
Red Bat	<i>Lasiurus borealis</i>	Vespertilionidae
Horay Bat	<i>Lasiurus cinereus</i>	Vespertilionidae
Townsend's Big-eared Bat	<i>Corynorhinus townsendii</i>	Vespertilionidae
Pallid Bat	<i>Antrozous pallidus</i>	Vespertilionidae
Brazilian Free-tailed Bat	<i>Tadarida brasiliensis</i>	Molossidae
Western Mastiff Bat	<i>Eumops perotis</i>	Molossidae
Brush Rabbit	<i>Sylvilagus bachmani</i>	Leporidae
Feral Domestic Rabbit	<i>Oryctolagus cuniculus</i>	Leporidae
Desert Cottontail	<i>Sylvilagus audubonii</i>	Leporidae
Black-tailed Hare	<i>Lepus californicus</i>	Leporidae
Merriam's Chipmunk	<i>Tamias merriami</i>	Sciuridae
California Ground Squirrel	<i>Spermophilus beecheyi</i>	Sciuridae
Eastern Gray Squirrel	<i>Sciurus carolinensis</i>	Sciuridae
Western Gray Squirrel	<i>Sciurus griseus</i>	Sciuridae

Animal Species List (continued)

Common Name	Scientific Name	Family Name
Fox Squirrel	<i>Sciurus niger</i>	Sciuridae
Botta Pocket Gopher	<i>Thomomys bottae</i>	Geomyidae
California Pocket Mouse	<i>Chaetodipus californicus</i>	Heteromyidae
Narrow-faced Kangaroo Rat	<i>Dipodomys venustus</i>	Heteromyidae
Western Harvest Mouse	<i>Reithrodontomys megalotis</i>	Cricetidae
California Mouse	<i>Peromyscus californicus</i>	Cricetidae
Deer Mouse	<i>Peromyscus maniculatus</i>	Cricetidae
Pinyon Mouse	<i>Peromyscus truei</i>	Cricetidae
Dusky-footed Woodrat	<i>Neotoma fuscipes</i>	Cricetidae
California Vole	<i>Microtus californicus</i>	Cricetidae
Black Rat	<i>Rattus rattus</i>	Muridae
Norway Rat	<i>Rattus norvegicus</i>	Muridae
House Mouse	<i>Mus musculus</i>	Muridae
Coyote	<i>Canis latrans</i>	Canidae
Gray Fox	<i>Urocyon cinereoargenteus</i>	Canidae
Ringtail	<i>Bassariscus astutus</i>	Procyonidae
Raccoon	<i>Procyon lotor</i>	Procyonidae
Long-tailed weasel	<i>Mustela frenata</i>	Mustelidae
American Badger	<i>Taxidea taxus</i>	Mustelidae
Western Spotted Skunk	<i>Spilogale gracilis</i>	Mustelidae
Striped Skunk	<i>Memphitis memphitis</i>	Mustelidae
Mountain Lion	<i>Felis concolor</i>	Felidae
Bobcat	<i>Lynx rufus</i>	Felidae
Feral Pig	<i>Sus scrofa</i>	Suidae
Black-tailed Deer	<i>Odocoileus hemionus</i>	Cervidae
Feral Domestic Goat	<i>Capra hircus</i>	Bovidae
Western Pond Turtle	<i>Clemmys marmorata</i>	Emydidae
Western Fence Lizard	<i>Sceloporus occidentalis</i>	Iguanidae
Coast Horned Lizard	<i>Phrynosoma conronatum</i>	Iguanidae
Western Skink	<i>Eumeces skiltonianus</i>	Scinidae
Southern Alligator Lizard	<i>Gerrhonotus multicarinatus</i>	Anguidae
Northern Alligator Lizard	<i>Gerrhonotus coeruleus</i>	Anguidae
Rubber Boa	<i>Charina bottae</i>	Boidae
Ringneck Snake	<i>Diadophis punctatus</i>	Colubridae
Sharp-tailed Snake	<i>Contia tenuis</i>	Colubridae
Racer	<i>Coluber constrictor</i>	Colubridae
Coachwhip	<i>Masticophis flagellum</i>	Colubridae
Gopher Snake	<i>Pituophis melanoleucus</i>	Colubridae
Common Kingsnake	<i>Lampropeltis getulus</i>	Colubridae
California Mountain Kingsnake	<i>Lampropeltis zonata</i>	Coubridae
Common Garter Snake	<i>Thamnophis sirtalis</i>	Colubridae
Western Terrestrial Garter Snake	<i>Thamnophis elegans</i>	Colubridae
Western Aquatic Garter Snake	<i>Thamnophis couchi</i>	Colubridae
Western Rattlesnake	<i>Crotalus viridis</i>	Viperidae

Special Animals of Castle Rock State Park

COMMON NAME	SCIENTIFIC NAME	LEGAL	OCCURANCE AT UNIT ²		
		STATUS ¹	PRES	PROB	POSS
Coho salmon	<i>Onchorhynchus kisutch</i>	FT ³			
Steelhead trout	<i>Oncorhynchus mykiss</i>			FT	X
California red-legged frog	<i>Rana aurora draytoni</i>	CSC, FT		X(a)	
Foothill yellow-legged frog	<i>Rana boylei</i>	CSC			X(a)
California tiger salamander	<i>Ambystoma tigrinum californiense</i>	CSC, FC			X(a)
Leopard frog	<i>Rana peipens</i>	CSC			X(a)
Western pond turtle	<i>Clemmys marmorata</i>	CSC		X(a)	
California horned lizard	<i>Phrynosoma coronatum frontale</i>	CSC		X(a)	
Townsend's big-eared bat	<i>Corynorhinus townsendii</i>	CSC			X(b)
Pallid bat	<i>Antrozouus pallidus</i>	CSC			X(b)
Spotted bat	<i>Eumops perotis</i>	CSC			X(b)
Western mastiff bat	<i>Eumops perotis</i>	CSC			X(b)
Ringtail	<i>Bassariscus astutus</i>	CP		X(a)	
Mountain lion	<i>Felis concolor</i>	CP	X		
Black-shouldered kite	<i>Elanus caeruleus</i>	CP		X(a)	
Bald eagle	<i>Haliaeetus leucocephalus</i>	FT, CE			X(a)
Northern harrier	<i>Circus cyaneus</i>	CSC		X(a)	
Sharp-shinned hawk	<i>Accipiter striatus</i>	CSC	X		
Cooper's hawk	<i>Accipiter cooperi</i>	CSC		X(a)	
Golden eagle	<i>Aquila chrysaetos</i>	CSC, CP	X		
Merlin	<i>Falco columbarius</i>	CSC			X(a)
American peregrine falcon	<i>Falco peregrinus anatum</i>	FE, CE, CP	X		
Prairie falcon	<i>Falco mexicanus</i>	CSC			X(a)
Marbled murrelet	<i>Brachyramphus marmoratus</i>	FT, CE, CP		X(a)	
Burrowing owl	<i>Athene cunicularia</i>	CSC			X(a)
California spotted owl	<i>Strix occidentalis occidentalis</i>	CSC		X(a)	
Long-eared owl	<i>Asio otus</i>		CSC		X(a)
Black swift	<i>Cypseloides niger</i>	CSC		X(a)	
Vaux's swift	<i>Cypseloides vauxi</i>	CSC		X(a)	
Willow flycatcher	<i>Empidonax traillii</i>	FSS, CE		X(a)	
Purple martin	<i>Progne subis</i>	CSC		X(a)	
Loggerhead shrike	<i>Lanius ludovicianus</i>	CSC		X(a)	
Yellow warbler	<i>Dendroica petechia bewster</i>	CSC		X(a)	
Horned lark	<i>Eremophila alpestris</i>	CSC			X(a)
Yellow-breasted chat	<i>Icteria virens</i>	CSC			X(a)
Tricolored blackbird	<i>Agelaius tricolor</i>	CSC			X(a)

¹ Legal status as of 12/92

FE = Listed as endangered by the U.S. Fish and Wildlife Service.

FT = Listed as threatened by the U.S. Fish and Wildlife Service.

FSS = Federal (BLM and USFS) sensitive species.

FC = Candidate species for federal listing (existing biological information is sufficient to support listing, but not yet proposed).

CE = Listed as endangered by the State of California.

CT = Listed as threatened by the State of California.

CP = California Protected.

CSC = State of California Species of Special Concern.

² Occurrence at Unit

PRES = Recently observed in the park.

PROB = Likely to be found in the park if looked for; not documented since 1979.

POSS = Range of species may include the park during at least part of the season (some species documented in 1979 but the current presence in the park is questionable).

(a) = Species documented to occur in the park in 1979.

(b) = Species with no known documentation at the park.

³ Species extirpated from San Lorenzo River system.

No attempt was made to determine the occurrence of the invertebrates in the park.

Appendix C

Wildlife Habitat – Plant Community Relationship

Table 2

Crosswalk Between Wildlife Habitat Relationship System Habitat Types and Terrestrial Plant Communities (Holland 1986).

<u>Wildlife Habitat Type</u>	<u>Plant Community</u>
Redwood.	Upland Redwood
Closed-cone Pine-Cypress.	Knobcone Pine Forest
Montane Hardwood-Conifer.	Mixed Evergreen Forest
Montane Hardwood.	Mixed Evergreen Forest
	Black Oak Woodland
	Interior Live Oak Woodland
Mixed Chaparral.	Northern Mixed Chaparral
Annual Grassland.	Non-native Grassland
	Bald Hills Prairie
Montane Riparian.	White Alder Riparian Forest
Riverine.	No analogue
Lacustrine (i.e., ponds and lakes) . . .	No analogue

Blank page

Appendix D

Selected Systemwide Resource Management Directives

The following directives are taken from “Resource Management Directives for the California Department of Parks and Recreation”, May 1979, and Chapter 18 of the Department Operations Manual:

- #5 Development in state parks is to be located and designed to protect and enhance enjoyment of the primary resources. In state parks, the primary purpose for development is to place visitors in an optimal relationship with the resources, for recreational enjoyment and understanding of those resources. In state parks, resources may not be managed or manipulated to enhance recreational experiences.
- #9 Boundaries of wilderness and natural preserves will be established to give full protection to environmental and ecological integrity, from the standpoints of watershed influences, scenic and visual unity, cultural values, and other appropriate environmental factors.
- Developments in natural preserves are limited to trails and interpretive facilities required to make possible the visual and sensory enjoyment of the resources by visitors. Vehicle access and parking are not appropriate; visitor centers, restrooms, structures, and facilities other than signs shall be placed outside natural preserves.
- #26 It is an objective of the Department to identify the total framework of environmental and ecological factors influencing the lands of the State Park System, including those arising from human activities, and to promulgate and apply resource management techniques required to negate deleterious human influences, and to achieve the environmental objectives established for the system.
- #27 Wherever natural elements are recognized in the State Park System as being of special significance requiring protection and preservation, and regardless of the classification of the units in which they occur, the Department shall recommend establishment of natural preserves (PRC Section No. 5019.71), to embrace these elements, and to emphasize their recognition and protection.
- #28 It is a primary responsibility of the Department to evaluate the ability of State Park System environments to withstand the impact of visitor use. Developments in any unit of the system shall not be of such capacity, nor uses be of such intensity, that significant ecological damage or deterioration of any environmental factor can reasonably be expected to occur. If deterioration is caused by overuse, steps are to be taken to reduce the intensity of use, and to rehabilitate the damaged resources.
- #29 In the State Park System, perpetuation of values in today’s environment may require a purposeful guiding of dynamic ecological factors that are constantly undergoing a successional trend through the interaction of natural and extraneous forces. This guidance may not always involve simply the static protection of the features or elements that happen to be a part of the existing environment in any particular period of time.

- #34 Except in those areas where it is perpetuated for resource management of historical reasons, aggressively invading exotic vegetation will be systematically removed when it becomes established anywhere in the State Park System; first priority in the effort will be given to invasions in state parks, state reserves, natural preserves, and wildernesses.
- #35 It is an objective of the Department to maintain the natural faunal habitat, wherever possible. The natural wildlife habitat is defined as the nature of the wildlife resources and habitat of each area before Euro-American modification.
- #36 Whether or not restoration of natural conditions is possible, it shall be an objective of the Department to avoid large imbalances in the wildlife population, using habitat management wherever possible. If it is necessary to regulate the populations of native animals by other than natural means, the methods used shall be efficient, humane, and as unobtrusive as possible. Restoration and maintenance of a natural faunal balance shall be the goal of the Department.
- #37 The Department shall conserve the soils of the State Park System, and to that end, shall prevent, if possible, or control destructive or unnatural erosion by means that are in harmony with the purposes of each unit. In state parks, reserves, natural preserves, and wildernesses, artificial controls shall be introduced only under the most extreme circumstances, and then only when conversion to a natural condition in the future is the objective. Where corrective measures are needed, all measures used shall be as unobtrusive as possible, fitting as naturally as possible into the environment, with the objective of restoring the natural condition.
- #38 It will be an objective of the Department to control and regulate the climbing of rocks, peaks, coastal bluffs, and other eminences, to prevent deterioration of such features. When it is necessary to install visitor facilities such as trails, steps, railings, etc., the work will be done so the facilities harmonize with the geological features and their environments.
- #39 It will be an objective of the Department to eliminate promptly any defacements of geologic features, and to restore the damaged sites to as natural an appearance and condition as is possible.
- #41 Paleontological resources in the State Park System shall be protected against damaging influences, including deterioration or adverse modification of their environment. Sites proposed for development will be evaluated for paleontological resources in the preliminary planning stage. Stabilization of paleontological resources may be required to prevent loss, but will be done in ways that protect the integrity of the sites.
- #43 The Department will continually strive to avoid degrading park system values by diversion of waters, by the alteration of stream regimens, or by allowing pollution to occur.
- #46 In each park system unit, environmental quality shall be such that visitors are aware of being in a place of special quality because of their surroundings. Man-made features and their maintenance will have special qualities, which, in total, express a feeling of environmental quality that differs from areas where degrading and undesirable features and intrusions are commonplace.
- #58 Cultural resources in the State Park System shall be protected against damaging or degrading influences, including deterioration or adverse modification of their environments. All evidence of such resources shall be investigated by qualified personnel, as designated by the Director, before any restoration, reconstruction or development is begun. If stabilization of cultural remains is

required to prevent loss or deterioration, it shall be undertaken in ways that shall not threaten archaeological, historical, or related environmental values.

- #60 Management and interpretation of human history in the California State Park System shall be built around the continuous flow of human experience, with appropriate emphasis on key features and circumstances, but always with full recognition of the need to show, and to achieve an understanding of, the interdependence between the past, the present, and the future.
- #63 Realization of the objectives embodied in approved resource elements may require preparation of carefully designed cultural resource management programs. Such programs shall set forth detailed descriptions of management procedures to be employed, including schedules and management techniques, and shall define the priorities and evaluations on which the program is based.
- #74 In state parks and state reserves, recreational facilities may be operated to enable the public to see, use, enjoy, and understand the primary resource in accordance with the resource element for the unit. The primary resources may not be modified, manipulated, or impaired, to create or enhance recreational opportunities.

Blank page

Appendix E

1998 Trails Inventory and Existing Roadside Parking

Table 3

CASTLE ROCK STATE PARK 1998 TRAILS INVENTORY

EXISTING TRAIL	TYPE OF USE	DISTANCE (miles)	LOCATION
Castle Rock Trail	pedestrian	0.59	Parking lot to Castle Rock to Saratoga Gap
Summit Meadows Trail	pedestrian	1.06	Sempervirens Point to Red Mountain
Loghry Woods Trail	pedestrian	1.76	Skyline Trail to Service Road Trail
Skyline-to-the-Sea Trail	pedestrian	6.51	Saratoga Gap to Waterman Gap
Ridge Trail	pedestrian	1.76	Saratoga Gap Trail (south) to Saratoga Gap Trail (north)
Saratoga Gap Trail (Sec. A)	pedestrian	2.62	Parking lot to campground
Saratoga Gap Trail (Sec. B)	pedestrian, equestrian, veh.	3.08	Saratoga gap to campground (dirt and paved road, fire road)
Service Road Trail	pedestrian, equestrian, bicycle, veh.	1.00	State Highway 35 to campground
Frog Flat Fire Road Trail	pedestrian	0.57	Headquarters bypass route north along Saratoga Gap Trail
Saratoga Toll Road Trail	pedestrian, equestrian	7.09	Saratoga Gap to Hwy. 9 intersection with San Lorenzo River *
Sky-to-Sea Interconnector Trail to Toll Rd.	pedestrian, equestrian	1.87	Southern end of toll road to Skyline-to-the-Sea Trail *
Skyline Trail	pedestrian	1.71	Saratoga Gap to approximately Postmile 12.6 on Hwy. 35 *
Link Trail	pedestrian	0.10	Parking lot to Skyline Trail *
Goat Rock Trail	pedestrian	0.37	Ridge Trail to interpretive shelter to Goat Rock
Beekhuis Road Trail	pedestrian, equestrian	1.50	Dirt road from Hwy. 9 to Saratoga Gap Toll Road Trail
Travertine Springs Trail	pedestrian	2.09	Saratoga Gap Trail to Saratoga Toll Road Trail
Cut-off Trail	pedestrian	0.20	Beekhuis Road Trail to Skyline-to-the-Sea Trail
Interconnector Trail	pedestrian	0.20	Ridge Trail to Saratoga Gap Trail

* Portion of trail is located off state park property, but under agreement for DPR management and public use. The State portion of the Skyline Trail stops at Postmile 25.6 for a distance of 1.7 miles.

TRAILS SUMMARY

Hiking Only	19.54 miles	Hiking trails opened for pedestrian use only
Hiking and Horseback Riding	13.54 miles	Trails opened for hiking and horseback riding only
Hiking, Horseback Riding, Bicycles	<u>1.00</u> miles	Service Road Trail opened for multiple use (provides bicycle access to trail camp)
Total Trails:	34.08 miles	Miles of trail owned or managed by DPR

Table 4

EXISTING ROADSIDE PARKING

NAME	LOCATION Postmile (side of hwy)	CAPACITY estimated avg.	NOTES
<u>Highway 9 (Saratoga Gap to Waterman Gap)</u>			
Trailhead**	26.90 (east)	15 cars	would accom. 4 horse trailers, call box
	26.81 (west)	15 cars	water wells exist in center
	26.78 (east)	10 cars	
	26.71 (east)	3 cars	
Oil Creek**	26.68 (west)	10 cars	
	26.24 (west)	7 cars	
Red Mtn.**	26.00 (west)	40 cars	two separate areas, gate, call box
Hoe Gate**	25.90 (east)	10 cars	gated access to old horse camp
	25.46 (west)	10 cars	
Semper. Pt.**	25.20 (east)	30 cars	1998 const. improvements (21 cars, bus)
	25.10 (west)	7 cars	
	24.68 (east)	7 cars	
	24.50 (east)	7 cars	near passing lane
	24.45 (west)	15 cars	
	24.39 (west)	15 cars	call box
	23.54 (east)	3 cars	
	23.33 (east)	3 cars	
Beekhuis**	23.31 (west)	3 cars	
	23.02 (west)	5 cars	
	22.97 (west)	2 cars	
	22.80 (west)	7 cars	
	22.61 (west)	3 cars	
	22.48 (west)	2 cars	
	22.38 (east)	5 cars	
	22.12 (east)	7 cars	call box
	22.03 (east)	10 cars	
	21.95 (east)	5 cars	
Trail camp**	21.57 (east)	5 cars	
Trail camp**	21.43 (west)	7 cars	turnout
Waterman**	21.00 (west)	<u>20 cars</u>	call box
Hwy. Roadside Parking:		288 cars	
<u>Highway 35 (Saratoga Gap to Indian Rock)</u>			
Vista	13.80 (west)	4 cars	vista parking (views to the west)
Loghry**	13.00 (east)	5 cars	
Summit Rock**	(east)	35 cars	trailhead to Summit Rock (Sanborn Co.)
Castle Rock.**	(west)	32 cars	outside main parking lot
Indian Rock.**	(east)	<u>20 cars</u>	trailhead to Indian Rock (Sanborn Co.)
Hwy. Roadside Parking:		96 cars	
TOTAL ROADSIDE PARKING		384 cars	

** These locations have developed trail access

Appendix F

CALIFORNIA STATE PARK AND RECREATION COMMISSION STATEMENTS OF POLICY

POLICY IV.2

NON-MOTORIZED BIKE USE

(Amended 5-4-94)

Preface

This policy is based on the recognition: that bicycling on unpaved roads and trails (nonmotorized biking) has become a popular recreational activity; that providing areas for non-motorized biking in the State Park System is consistent with our mission to provide recreation opportunities for the general public; and, that the increasing use of mountain bikes has created a need to develop management policies to reduce the potential conflicts with other users and the impact on park resources.

Policy

This policy is intended to provide for non-motorized bike use that is consistent with the Department's responsibilities to all users and to the stewardship of park resources.

Generally, paved and unpaved* park roads are open and trails closed to bicycles. This policy will take effect for trails after district management completes a use determination of major trails and the signing of each. Unpaved roads may be closed and trails opened upon a written determination by the district superintendent that specifically considers criteria as outlined in this policy. Trails currently approved for non-motorized bike use should be given special consideration for continued use, based on criteria below.

Special Restrictions

1. Bicycles will be operated, especially when passing users, at a safe speed and in a responsible manner as determined by Department staff.
2. Bicycles are prohibited in areas classified as wilderness.
3. Bicycles are allowed only on paved roads in State Reserves and in Cultural or Natural Preserves.
4. As with other trail uses, off-trail or off-road (cross country) bicycle use is prohibited in all units.

*Unpaved park roads are defined as fire roads, dirt roads, and service roads with a width of over 60 inches.

DETERMINATION CRITERIA

1. Safety of bike user and other park users:
 - width, slope, visibility, grade, length, surface of road or trail
2. Impact of trail/road use on the unit's environment:
 - wildlife, plants, cultural resources, soil condition, aquatics
3. User conflicts:
 - impact on recreation experience of other users
4. Volunteer participation by members of the mountain bike community in conjunction with efforts of other trail users:
 - volunteer patrols, trail/road building, and maintenance and user education
5. Purpose of the area within the unit:
 - zones (primary historic zone, open space, entrance, etc.), interpretive trails
6. Compatibility with adjoining land management of trail/road corridor.
7. Demonstrated demand for activity (public testimony as appropriate).
8. Ability to accommodate activity:
 - staffing, including volunteer patrols
 - carrying capacity
9. Seasonal conditions which might require periodic closure.
10. Type of trail/road:
 - point-to-point access
 - through travel
 - loop trails

Appendix G

ROCK CLIMBING POLICY

Department Operations Manual, Chapter 1600, Natural and Cultural Resources
Policy No. 1622.11, September 9, 1993

Technical rock climbing is a form of recreation practiced in several park units. To protect resources and avoid conflicting uses, Superintendents may designate specific climbing areas, restrict the types of climbing, require mitigation, or close areas pursuant to a posted notice. When new climbing areas are proposed, a CEQA review should be initiated to determine if impacts from climbing are detrimental to scenic, natural, cultural and/or recreational resources.

Rock climbing activities should not be routinely restricted for reasons of liability. Per Government Code Section 831.7, the Department is immune from liability for visitors engaged in such inherently dangerous recreational activities. The Department may be liable, however, if it encourages the activity or involves itself with the equipment used; therefore, Districts will not take part in rock climbing activities, or inspect, place or maintain climbing equipment. Climbers are responsible for maintaining their own equipment, and the Department is responsible for insuring that resources are adequately protected.

Blank page

Appendix H

CASTLE ROCK STATE PARK
GENERAL PLAN AMENDMENT
and Supplement EIR
For
Walk-in Campsites at Partridge Farm

Approved by the State Park and Recreation Commission
October 2000



GRAY DAVIS
Governor

RUSTY AREIAS
Director

MARY NICHOLS
Secretary for Resources

Department of Parks and Recreation
P.O. Box 942896 Sacramento, California 94296-0001



STATE PARK AND RECREATION COMMISSION

P. O. Box 942896
Sacramento, California 94296-0001
(916) 653-0524 FAX: (916) 654-6374

Resolution 19-00
adopted by the
CALIFORNIA STATE PARK AND RECREATION COMMISSION
at its regular meeting in San Jose
October 25, 2000

WHEREAS, the California State Park and Recreation Commission directed the Department of Parks and Recreation to re-evaluate the issue of camping at Castle Rock State Park and, if appropriate, to prepare an amendment to the General Plan addressing this subject at a Commission meeting; and

WHEREAS, the Director of Parks and Recreation has presented to this Commission for approval the proposed amendment to the General Plan for Castle Rock State Park; and

WHEREAS, this document reflects long-range development plans to provide for optimum use and enjoyment of the unit as well as the protection of its quality, resources, and diversity;

NOW, THEREFORE, BE IT RESOLVED that the California State Park and Recreation Commission hereby approves the Department of Parks and Recreation's Castle Rock State Park General Plan Amendment dated June 20, 2000, subject to such environmental changes as the Director of Parks and Recreation shall determine advisable and necessary to implement the provisions of said plan.

TABLE OF CONTENTS

1	INTRODUCTION
1	BACKGROUND
2	PROJECT DESCRIPTION
5	ENVIRONMENTAL ANALYSIS
5	SUMMARY / INTRODUCTION
5	DESCRIPTION OF THE EXISTING ENVIRONMENT
6	SIGNIFICANT ENVIRONMENTAL EFFECTS AND MITIGATION
6	Cultural Resources
7	Traffic
9	Hydrology and Soils
10	Geology
11	Wildlife
12	Esthetics
13	ALTERNATIVES
13	Traditional Campground Development
14	No Project Alternative (General Plan Approved Development)
14	IRREVERSIBLE ENVIRONMENTAL CHANGES
15	GROWTH INDUCING IMPACT
15	NON-SIGNIFICANT ENVIRONMENTAL EFFECTS
15	Noise
15	Wildfire
16	Black Oak Woodland
16	Water and Sewage
17	REFERENCES / PERSONS CONSULTED

LIST OF MAPS AND FIGURES

iii	Map 1	VICINITY MAP – Santa Cruz Mountains
4	Map 2	PROPOSED WALK-IN CAMPSITES

APPENDICES

19	Appendix A	SP&R Commission Resolution (General Plan), 3/08/00
20	Appendix B	SP&R Commission Resolution (Natural Preserve), 3/08/00

Blank page

Castle Rock State Park
General Plan Amendment
PROPOSED WALK-IN CAMPSITES

INTRODUCTION

On March 8, 2000, the State Park and Recreation Commission approved the preliminary general plan for Castle Rock State Park and classified a large portion of the park as a natural preserve. In approving this plan, the commissioners also expressed their support for walk-in campsites to improve access opportunities for visitors in the Partridge Farm area. The purpose of this amendment is to include a development proposal of approximately 20 walk-in campsites in the Castle Rock State Park General Plan. The original camping component of the plan was withdrawn from Commission consideration at the general plan hearing due to concerns raised with regard to the analysis of the impacts of the camping proposal in the draft plan that had been circulated for public comment (*see Appendix A for Commission Resolution*).

BACKGROUND

Castle Rock State Park offers visitors an opportunity to visit a ridge-top environment, which is a portion of the Foothills and Low Coastal Mountains Landscape Province. It provides trailhead opportunities for use of trails at Castle Rock and in the Midpeninsula Regional Open Space Preserves and Bay Area Ridge Trail, and hikes from the ridge to the ocean via the Skyline-to-the-Sea Trail (approximately 30 mile, three-day trail hike). Most of the Santa Cruz Mountain's region is very accessible to the local communities of the lower peninsula for a bicycle day-trip or visit by automobile any time of the day. Castle Rock State Park also provides primitive trail camps for park visitors and backpackers along this regional trail system.

Camping opportunities in the Santa Cruz Mountains and vicinity of Castle Rock State Park exist at Portola Redwoods State Park (12 miles or 35 minutes to the northwest), Big Basin Redwoods State Park (15 miles or 40 minutes to the southwest), and Sanborn-Skyline County Park (6 miles or 25 minutes to the east). These state and county parks provide an overnight experience for conventional car campers in the redwood forest and canyons, and focus the users on recreational activities within those park units. Camping facilities at these other parks include walk-in and family tent campsites, group facilities, tent cabins, as well as recreation vehicle hook-ups provided at the county park. Overnight visitors from major metropolitan areas outside the Santa Cruz Mountains region must make reservations for campsites due to the popular demand for these facilities. Campsites in county parks are available on a first-come, first-served basis.

The park was evaluated during the general plan process for its potential to create opportunities for high-quality outdoor recreation, consistent with its resource values and classification. It was recognized at that time, some park visitors enjoyed a primitive type of recreational experience and would like extended hours of use; still, others wanted campsites that were more accessible from the main parking lot. However, potential sites for locating new campground facilities is limited. Partridge Farm is considered the only site within current state park ownership that is favorable for this type of facility. It is also recognized that sensitive natural and cultural resources exist in adjacent areas.

PROJECT DESCRIPTION

The management intent is to establish approximately 20 walk-in campsites in the Partridge Farm Area. These campsites will be designed for a visitor experience similar to trail camps, but with greater accessibility to parking and restroom facilities. Visitors will be required to walk a reasonable distance from a common parking area to walk-in campsites situated in a natural setting. Unlike automobile campgrounds, campers will not have vehicle parking next to each campsite. Campsites and support facilities will be designed to create an accessible environment for visitors and minimize visitor impacts on natural and cultural resources.

As directed by the general plan, an overall site plan will be prepared for Partridge Farm, with the guidance of resource inventories, studies, and review. This site plan will include such components as: vehicle access, visitor contact, park office, parking and circulation, day use and overnight use areas, interpretive and operations facilities, cultural protection, buffer zones, and native plant restoration. The proposed campsites would be developed in a third phase of park development, only after the first two phases, which includes day use parking and visitor contact facilities. Resource assessment and monitoring will occur in the vicinity of Partridge Farm prior to development, which is subject to further environmental review.

GOAL: Expand access and overnight opportunities for visitors.

Guidelines:

- Approximately 20 walk-in campsites may be developed for a tent camping experience in the Partridge Farm Area. Campsites will be set into a natural setting and accessible by trail to and from developed parking and restroom facilities located out of view from the campground.
- Overnight visitor parking (approximately 30 spaces) will be screened with native plants and centralized or clustered away from the walk-in campsites.
- Restroom facilities will be small in scale and blended into the existing terrain and landscaped with native vegetation. Restroom locations shall be based on the overall

site plan prepared for the Partridge Farm Area, including provisions for day use and overnight use facilities.

- The design and layout of campground facilities shall consider compatibility with other uses and programs (i.e., day use, special activities, operations, natural and cultural resource management, and interpretive programs) identified in the general plan for the Partridge Farm Area.
- Pathways connecting campsites to park trails shall guide users through the least sensitive resource areas.
- Campsite provisions should be made for people with disabilities.
- Prior to any facility development, a resource assessment and monitoring program will be implemented in order to evaluate impacts and guide future management decisions regarding public access and visitor use in the Partridge Farm Area and its surroundings. Development projects shall include provisions for the restoration and protection of native vegetation and protection of cultural features.
- A campfire center may be considered in the overall site plan for the Partridge Farm Area.

PROPOSED WALK-IN CAMPSITES - MAP NO. 2

The map shown on the following page describes the area of potential development for walk-in campsites at Partridge Farm. This area also includes the site for day-use parking facilities proposed in the approved general plan for this unit. This area shown is considered to be conceptual for general plan purposes only, and does not reflect the actual boundaries of proposed facilities development. A future area development plan and detailed site investigations will determine actual facilities location and design.

Castle Rock SP General Plan Amendment PROPOSED WALK-IN CAMPSITES

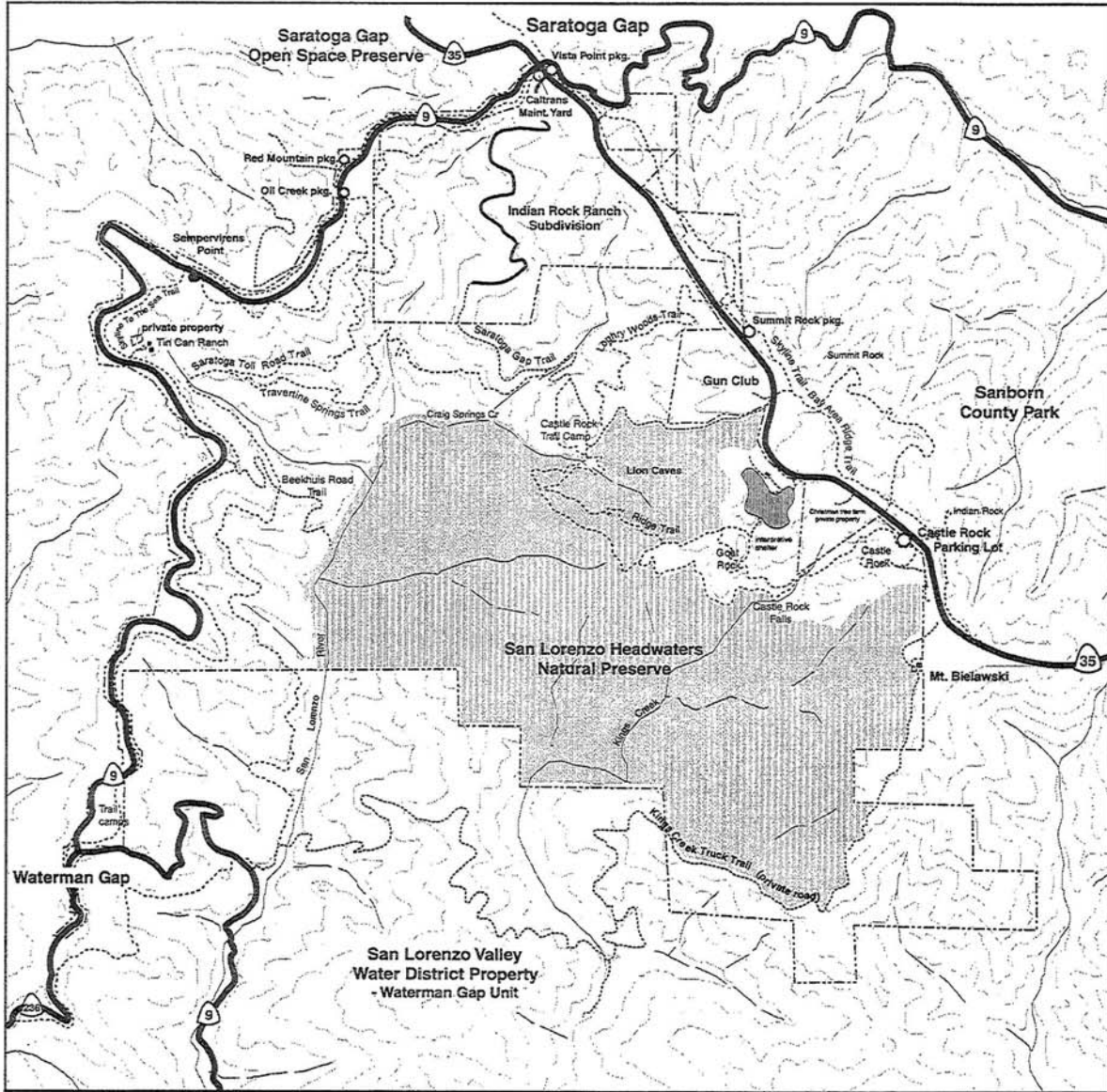

Area of Potential Development
(Includes Day Use & Overnight Use Facilities)

Note: This area is considered to be conceptual for general planning purposes only, and does not reflect the actual boundaries of proposed facilities development.

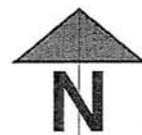

No Scale
MAP 2

ENVIRONMENTAL ANALYSIS

(GP Amendment)

SUMMARY/INTRODUCTION

This document is a supplement to the EIR prepared for the Castle Rock State Park General Plan that covers the proposal for an addition of approximately twenty walk-in sites at Partridge Farm.

This supplement examines the potential environmental impacts of camping in greater detail than the EIR for the General Plan recognizing the concerns the public expressed for campground development during the CEQA review of the preliminary general plan. However, this supplement is a first tier review whereby subsequent area development plans for the Partridge Farm area will be subject to further environmental review requirements of the California Environmental Quality Act.

This supplement considers the impact of the addition of camping and the cumulative impact of camping along with the development previously approved in the General Plan.

DESCRIPTION OF THE EXISTING ENVIRONMENT

The Partridge Farm area is described in the General Plan, Natural Resources Inventory of Castle Rock State Park and the Upper San Lorenzo River Basin Boisseranc Inventory and An Inventory of the Cultural Features of the Boisseranc Unit, Castle Rock State Park, Santa Cruz County. These documents, incorporated by reference, are available for public review at the Santa Cruz District Office at 600 Ocean Street, Santa Cruz and the Northern Service Center at 1725 23rd Street, Room 200, Sacramento, California.

In summary, the Partridge Farm area has been substantially modified by agricultural activities and other uses over the last 100 years. It is recovering to a more natural-appearing landscape as native vegetation reestablishes itself. It is surrounded by the Black Oak woodland and the unique and sensitive Lion Caves and Castle Rock Ridge areas.

SIGNIFICANT ENVIRONMENTAL EFFECTS AND MITIGATION

CULTURAL RESOURCES

Area of Potential Effect

The area of potential impact includes the Partridge Farm area, and adjacent Lion Caves and Castle Rock Ridge Areas.

Threshold

Loss, destruction, or human-induced deterioration of a known cultural resource, recognized by the Department to have integrity and significance, will be considered a significant impact.

Impact of Camping

There is a significant cluster of six prehistoric sites in the Partridge Farm area. These sites represent a seasonal camp of undetermined age. Some possible rock art was recently identified in the large rock formations within the vicinity of Partridge Farm; other rock art sites may exist within the park. In general, prehistoric resources are scarce in the park and, therefore, all are potentially significant.

The Partridge House/Bungalow is the remaining significant historic resource in the Partridge Farm area. The existing apple and pear orchards are potentially historically significant.

The General Plan calls for the protection of all historic and prehistoric sites and features from adverse effects resulting from park use, development, and management activities. The Partridge House will be maintained with consideration of appropriate adaptive uses. No camping facilities would directly impact these sites. The continuation of the house as an employee residence or other use (i.e. unit administrative) would discourage public vandalism of the sites.

The camping facility would not be located near the Partridge House or existing orchards. There would be no significant impact.

There is a potential significant impact to unrecorded or unknown resources in the Castle Rock Ridge Area.

Impact – Cumulative

The cumulative impact of camping and day use on cultural resources will be the same as the impact for camping.

Mitigation

1. Site-specific cultural resource surveys will be conducted in areas proposed for development and where other surface disturbing activities occur in the Lion Caves and the adjacent Castle Rock Ridge Areas. No public use facilities will be constructed on or near known prehistoric or historic sites, in accordance with the Department's resource management directives and professional standards for the treatment of historic properties.
2. A buffer zone will be designated around the facility development area at Partridge Farm to protect the cultural resources and other sensitive habitats and resources.
- 3 Any modification, maintenance, or improvements to the Partridge House will be done in conformance with the Secretary of Interior's Standards for the Treatment of Historic Properties.
4. All development and resource management plans will be subject to meeting PRC 5024.5 review requirements. These cultural effect review requirements will be met at the time the plans are prepared.

TRAFFIC

Area of Potential Effect

The area of potential effect includes the two state highways (35 and 9) along the borders of Castle Rock State Park, the intersection of the two highways (Saratoga Gap), and the proposed entrance to the Partridge Farm area.

Threshold

A reduction in the level of service below "Level C" or development of an access with inadequate sight distance will be considered a significant impact.

Impact – Camping

Caltrans rates level of service on roadways with a scale from "A" to "F". The rating is not wholly dependent on the number of vehicles but also on the nature of the flow, speeds, and delays. Level of service "A" represents unrestricted operation; Level F represents overcapacity flows with heavy congestion and

considerable reductions in speed. Level "C" is still stable flow; although it approaches the range where instability may occur because of small changes in flow. Caltrans design standard level of service for freeways and highways is Level "C". Maximum volume (passenger cars per hour in one direction) for rural two-lane highway for "B" level of service is 900 under ideal conditions (Fundamentals of Traffic Engineering, 8th edition, Institute of Transportation and Traffic Engineering, University of California, Berkeley, 1973).

The camping proposal will add about 60 trips per day maximum (30 parking spaces X 2 trips/space/day). The increase in traffic volume would be less of an impact than the potential safety hazard of vehicles accessing and egressing at the present Partridge Farm entrance. Regular visitor use of the Partridge farm area would require an improved developed access and entrance road for public safety reasons. Visitors tend to avoid peak (commute) traffic periods and, therefore, should not contribute to peak traffic volumes.

The current peak hour traffic on Highway 35 between Partridge Farm and Saratoga Gap is 440 trips per hour. The practical capacity of this roadway is about 900 vehicles per hour. If the daily traffic volume from camping (60 vehicle trips) were generated in one hour, in addition to the peak hour traffic of 440 trips/hour, it would not exceed the practical capacity of this roadway.

Impact – Cumulative

The cumulative increase of the day use and camping proposals at Partridge Farm could add 460 trips per day maximum (100 spaces X 2 trips/day/space X 2 (turnovers) + trips generated by camping). The cumulative impact on traffic volume of all development at Partridge farm approaches the practical capacity (if all trips generated by Partridge Farm visitor development occur during the peak hour, an unlikely occurrence). Visitor traffic or trips generally occur during off-peak hours and spaced throughout the day. A more probable scenario would be one trip generated for every parking space (approximately 100 day use and 30 camping) at the peak hour. These 130 trips, in addition to the peak hour traffic, are still below the practical capacity. There is still the potential traffic hazard at the intersection of the highway and the Partridge Farm entrance road. The day use parking at Partridge Farm will replace the parking removed at the current main parking area and the highway; therefore, the impact at the Saratoga Gap intersection will be negligible. The only increase in trips generated is from the proposed camping.

Mitigation

Mitigation for the potential safety hazard will not be prescribed now. The Department will consult with the California Department of Transportation to design a safe access into Partridge Farm area at the time site-specific development plans are prepared. Road and access improvements will conform

to Caltrans standards and specifications when implemented. Possible mitigation is the relocation of the entrance road, construction of deceleration lanes, and construction of turn lanes.

HYDROLOGY AND SOILS

Area of Potential Effect

The area of potential effect includes the areas of Partridge Farm, Castle Rock Ridge, and Lion Caves.

Threshold

A reduction in water quality and/or increased soil erosion will be considered a significant impact.

Impact – Camping

Even though project developments will occur within a limited portion of the park (Partridge Farm Resource Management Zone), development, maintenance and use of facilities such as roads, trails, parking lots, campsites, picnic areas, utilities, septic systems, and buildings, have the potential for significant short and long-term impacts to the environment. These impacts could include soil disturbance, dust, increased erosion, altered drainage patterns, and lowered water quality.

Quantification and determination of the impacts is speculative without more defined plans.

Impact – Cumulative

The cumulative impacts are considered the same as those described for camping above.

Mitigation

Design, construction and maintenance of facilities will follow the best management practices for the elimination or reduction of adverse effects to soil stability, water quality, and drainage patterns. Activities or development that could adversely affect the park's aquatic systems will be mitigated to a level of non-significance, where feasible.

GEOLOGY

Area of Potential Effect

The area of potential effect includes the areas of Partridge Farm, Castle Rock Ridge, and Lion Caves.

Threshold

Damage to unique or significant geological features will be considered a significant impact.

Impact – Camping

There is a potential impact to tafoni as a result of climbing activities, vandalism, and unintentional damage from intensive use. Improved access at Partridge Farm may encourage greater public use of the surrounding areas possessing tafoni features. Consultations with geologists confirmed that the tafoni are sensitive and endangered. The durability of the tafoni features has not been studied and is most likely variable, with some rock features more durable than others.

Impact – Cumulative

The cumulative impacts are considered the same as those above. On the basis of the number of visitors involved, the day use development (460 visitors) has a responsibility for the greater portion of the impact than camping (70 visitors). It should be recognized that the day use visitation at Partridge Farm is a result of the relocation of existing day use parking and may not create any substantial difference in effect.

Mitigation

No climbing will be permitted in the area classified as a natural preserve. The Department will prepare a climbing management plan that will include measures to prevent damage to tafoni from climbing activities outside the San Lorenzo Headwaters Natural Preserve. Proposals to protect tafoni in the plan may include designation of climbing areas, equipment restrictions, and closures. Interpretation and education of visitors can reduce the unintentional degradation and vandalism of these features.

WILDLIFE

Area of Potential Effect

The area of potential effect includes the entire state park, depending on the sensitivity and area requirements of the species. The area of greatest effect includes the Partridge Farm resource management zone and adjacent areas.

Threshold

Direct take or removal of individuals of a sensitive species, reduction in area, or alternation or disturbance of required habitat will be considered a significant impact.

Impact – Camping

The additional availability of garbage and the direct feeding of wildlife by campers, in conjunction with that of day use visitors, may attract disproportionately large populations of nest predators, including raccoons, striped skunks, opossums, and corvids (jays, ravens and crows), in and adjacent to the project area. Increased large predator populations may adversely impact Neotropical migrant songbirds, non-migrant native birds, amphibians and reptiles using hardwood, montane-hardwood and grassland habitats occurring in the Partridge Farm and adjacent Resource Management Zones. Evidence of the impact is inconclusive; a determination of significance would be speculative.

The siting of camping facilities may degrade sensitive plant or animal populations or their habitat. Brewer's calandrina, a sensitive plant species, occurs in the park; however, inventory searches failed to find any in the campground area. Mountain lions have been documented to occur in the park; however, population statistics, regional wildlife movement, and tolerances of humans have not been established. Mountain lions have been documented in the Partridge Farm vicinity by Harvey and Stanley (1979), yet little is known of the species' use intensity there. No sign of mountain lions was observed in the Partridge Farm Resource Management Zone during 1995/96 inventories; during this time one mountain lion sighting was reported elsewhere in the park.

The project could result in disturbance to amphibian and reptile microhabitat from the illegal gathering of large woody litter for firewood; however, the Department enforces regulations against the illegal collection of firewood.

Impact – Cumulative

The cumulative impacts are considered the same as those described for camping above.

Mitigation

Site-specific searches for sensitive species of plants and animals will be conducted in areas proposed for development or for other activities. The Department will assess movement patterns by large, wide-ranging sensitive animal species using the Partridge Farm area and vicinity. The proposed project will be modified if necessary to avoid significant adverse impacts to any detected sensitive populations or areas that have established movement corridors of sensitive animal species.

ESTHETICS

Area of Potential Effect

The area of potential effect includes the areas of Partridge Farm, Castle Rock Ridge, and Lion Caves. Due to topography and vegetation, the viewshed from Partridge Farm is limited.

Threshold

New development in a natural-appearing landscape visible to neighbors or adjacent traffic would be considered significant.

Impacts – Camping

The area of potential development is not readily visible from the highway or by neighboring landowners. The proposed walk-in campsites will be generally screened by existing vegetation and topography, and thus will not result in significant visual impacts. Campsites will be designed and situated within the Partridge Farm area, with minimal disturbance to the existing landscape. A parking area with reflective parked automobiles and restroom building could be very obvious human imposed intrusions into the landscape. The activity and equipment associated with the walk-in campsites could also be an intrusion to the visual landscape for park users seeking a wilderness experience.

Human activities occurring outside the Partridge Farm area, in the vicinity of Goat Rock and Lion Caves, could impact the visual quality of the natural landscape through indiscriminate use (volunteer trails and deliberate acts of resource damage).

Impacts - Cumulative

The cumulative impacts are considered the same as those described for camping above.

Mitigation

Visual impacts can be mitigated by careful siting, design, and selection of materials. The restroom building design will be low profile and use muted, non-reflective exterior colors that blend, rather than contrast, with the surrounding environment. Designated trails throughout the Castle Rock Ridge and into the Lion Caves area will be designed and situated to minimize the visual impact to the existing landscape, which includes restoration of previously impacted sites.

Parking will be developed and screened by landscaping to help break up surfaces of potential glare and views from the walk-in campsites, highway, and adjacent private properties.

Landscaping with native plant species will be provided at the campground perimeter and throughout the walk-in campsites to screen views from parking areas and nearby trails, if needed. Native plant species compatible with existing vegetation would be required.

Low-profile lighting at the restroom building will be at a minimum level necessary for security and safety. Light fixtures that minimize glare will be required and directed downward to minimize light pollution of the dark skies.

ALTERNATIVES

There are two alternatives to be considered: (1) Traditional campground development alternative (2) the “no project” alternative (development approved by the Park and Recreation Commission).

TRADITIONAL CAMPGROUND DEVELOPMENT ALTERNATIVE

Traditional campground facilities would be developed, including campground roads and individual campsite parking spurs. Approximately twenty campsites would be designed for overnight use at Partridge Farm in addition to the day use and operations facilities already approved in the general plan. This alternative would result in construction of additional roads for campground vehicle traffic, with a reduction in consolidated parking for overnight use. Approximately 10 parking spaces will be developed for overnight visitor use of existing trail camps.

The potential significant environmental impacts resulting from this alternative would be the same as the approved general plan, with the potential increase in vehicle traffic movements related to the use of traditional camping vehicles. Additional surfaced campground roads will result in the loss of vegetative cover and wildlife habitat, increase surface run-off and potential soil erosion, and impact the esthetics of the natural-appearing landscape.

The traffic impacts and visual degradation impacts could be mitigated to non-significance through proper siting of facilities and landscaping. Individual parking spurs would be designed to blend into the natural surroundings to minimize the view of vehicle parking from the highway and adjacent private properties. Identified cultural resources in the Partridge Farm area will be avoided by locating facilities away from the sensitive areas. Impacts to sensitive plants and animals will be avoided by performing surveys for such species and locating facilities away from areas of identified occurrence.

NO PROJECT ALTERNATIVE – (GENERAL PLAN APPROVED DEVELOPMENT)

The “no project” alternative would be the development approved by the general plan. No camping facilities would be constructed. The approved development is reviewed in the General Plan EIR. In summary, the development proposed is 50 day use parking sites relocated from the highway (phase 1) ultimately 100 parking sites (50 sites relocated from the main parking lot), unit administrative office and initial public contact point, and adaptive use of the Partridge House. The potential significant environmental impacts resulting from this alternative would be a reduction in the level of service (congestion and safety hazard) at the existing entrance at Partridge Farm, visual degradation of the natural scenic qualities at Partridge Farm, take of Brewer’s calandrinia, and vandalism or unintentional destruction of cultural resources. The traffic impacts and visual degradation impacts could be mitigated to non-significance through proper siting of facilities and landscaping. The take or loss Brewer’s calandrinia is not possible to assess because unknown variables (prescribed burning, reduction of trails, etc.) affect the net result. Identified cultural resources in the Partridge Farm area will be avoided by locating day use facilities away from the sensitive areas. Some cultural resources have been discovered in the Castle Rock Ridge area; there is a potential impact to these and other unknown resources until they are properly identified and measures are designed to protect them where feasible. Impacts to sensitive plants and animals will be avoided by performing surveys for such species and locating facilities away from areas of identified occurrence.

IRREVERSIBLE ENVIRONMENTAL CHANGES

Any facility development is a long-term commitment of resources; however, impacts can generally be reversed through the removal of facilities, if necessary. Partridge Farm has already been extensively modified by agricultural activities and is recovering naturally. The Department will be monitoring sensitive resources in Castle Rock on an ongoing basis to direct management and development. If there are indications that impacts from visitor use may become excessive, the Department can reduce or remove facilities or take other appropriate actions.

GROWTH INDUCING IMPACT

Growth in the surrounding metropolitan/urban areas is dependent on housing and employment availability. The addition of 20 campsites at Partridge Farm will not remove any constraint to growth, will not require new staff needing new housing, nor will it induce new growth to this area. Population growth in nearby urban areas will generate demand for recreational opportunities and facilities with or without the facility development at Castle Rock State Park.

NON-SIGNIFICANT ENVIRONMENTAL EFFECTS

NOISE

A certain amount of noise will be generated from use and activities associated with the 20 walk-in campsites proposed for the Partridge Farm area. The projected daytime noise levels from campground use would be compatible with surrounding day use activities, highway traffic, and the adjacent gun club, and therefore, are not considered to be a significant noise impact.

Overnight use could affect associated wildlife species located in the vicinity of Partridge Farm, but noise levels are not projected to be significant. The type of camping experience we are offering in walk-in campsites is similar to trail camps, which limits the use of generators, music players, and frequent use of automobiles.

Discussion

The walk-in campsites will provide an outdoor experience for visitors who prefer separation from the automobiles, but for various reasons prefer not to or can not walk greater distances to established primitive sites.

Park rules and regulations for use of overnight facilities will be strictly enforced.

Landscaping for screening and buffers will also reduce noise level disturbance in surrounding areas.

WILDFIRE

Use of camping facilities within wildland areas has the potential to place the public at risk due to wildfires caused by inadvertent ignition from within, as well as from outside the park. Furthermore, the designation of a large portion of the park as Natural Preserve, with its limitations on off-trail travel and mechanized equipment could hamper suppression activities.

Discussion

No campfires or nighttime activity will be allowed outside the designated camping areas, including the Partridge Farm Resource Management Zone. Following State Park standards, these designated areas will be designed to reduce the chance of accidental escape of fire to surrounding vegetation. The existing Wildfire Management Plan will be reviewed and modified, as appropriate, to ensure protection of human lives and property, and will emphasize control of fires along predetermined suppression lines, which divide the park into control compartments. The Wildfire Management Plan will also include evacuation procedures.

BLACK OAK WOODLAND

A Black Oak Woodland, of limited distribution in the Santa Cruz Mountains, occurs directly adjacent to the Partridge Farm area. Adverse impacts from increased visitor use of this area may include soil disturbance by volunteer trails. These disturbed soils may allow for invasive exotic plant establishment.

Discussion

No camping facilities will be located in or near existing Black Oak Woodlands. The Castle Rock General Plan stipulates the development and implementation of an environmental monitoring program for the Partridge Farm and adjacent Resource Management Zones to help manage visitor use and protect resources. This program is intended to: 1) develop a quantitative methodology to establish baseline conditions, 2) set target ranges for resource conditions, 3) monitor environmental indicators, and 4) recommend remediation when impacts exceed target ranges. The General Plan also provides guidelines for: a) the development of a unitwide Vegetation Management Plan to perpetuate natural communities and processes, and control invasive exotic plant species, b) the development of a Watershed Management Plan to control erosion and sedimentation, and c) the development of a Unitwide Trails Plan in order to guide trail location and construction, and provide for appropriate maintenance. The intent of these resource protection mechanisms is to maintain resource impacts to levels less than significant.

WATER AND SEWAGE

Water supply required for the proposed camping would be about 1050 gallons per day (3.5 people/campsite X 20 campsites X 15 gallons/person/day). Day use water requirements would be about 2300 gallons per day (100 parking spaces X 2.3 people/car X 2 cars/parking space (turnover) X 5 gallons/person/day).

Cumulative water requirements for camping and day use would be 3350 gallons per day, or about 2.3 gallons per minute.

Discussion

Existing water supply can meet the requirements for both the proposed day use and camping. The existing well and pump at Partridge Farm has been tested to provide 20 gallons per minute for days with no significant draw down on the well water level. There is a 10,000 gallon water storage tank to meet short-term peak requirements in excess of well delivery.

Percolation tests will be conducted to determine the actual location and area requirements for a leach field. Initial restroom facilities may use a vault or tank to hold waste that would be periodically pumped out and treated elsewhere. There is sufficient acreage and percolation capacity to meet leach field requirements.

REFERENCES / PERSONS CONSULTED

Natural Resources Inventory of Castle Rock State Park and the Upper San Lorenzo River Basin, Harvey and Stanley Associates, 1979.

An Inventory of the Cultural Features of the Boisseranc Unit, Castle Rock State Park, Santa Cruz County, William Roop, Archeological Resource Service for Harvey and Stanley Associates, September 1982.

Sydney Brown, Senior Geologist, California Department of Parks and Recreation

Gary Waldron, Senior Resource Ecologist, California Department of Parks and Recreation

GP Amendment
APPENDIX A

Resolution 5-00
adopted by the
CALIFORNIA STATE PARK AND RECREATION COMMISSION
at its regular meeting in San Jose on
March 8, 2000

WHEREAS, the Director of the Department of Parks and Recreation has presented to this Commission for approval the proposed General Plan for Castle Rock State Park; and

WHEREAS, this document reflects long-range development plans to provide for optimum use and enjoyment of the unit as well as the protection of its quality, resources and diversity; and

WHEREAS, it is the Commission's view that added walk-in camping is desirable at Castle Rock State Park, therefore the Commission directs the staff to re-evaluate the issue of camping in this Plan and, if appropriate, to prepare an amendment to the Plan addressing this subject at a Commission meeting no later than six months from today;

NOW, THEREFORE, BE IT RESOLVED that the California State Park and Recreation Commission hereby approves the Department of Parks and Recreation's Castle Rock State Park Preliminary General Plan, dated February 1999, subject to such environmental changes as the Director of Parks and Recreation shall determine advisable and necessary to implement the provisions of said plan.

GP Amendment
APPENDIX B

Resolution 6-00
adopted by the
CALIFORNIA STATE PARK AND RECREATION COMMISSION
at its regular meeting in San Jose on
March 8, 2000

WHEREAS, the Director of the Department of Parks and Recreation has proposed an 1800-acre Natural Preserve be established in the core ecological area of Castle Rock State Park to provide for the recognition and protection of significant natural resources at the headwaters of the San Lorenzo River; and

WHEREAS, the proposed Natural Preserve contains highly significant natural, geologic and esthetic resources, including rare tafoni sandstone formations and a diversity of plant communities and wildlife habitats; and

WHEREAS, encompassed within the proposed boundaries of the Natural Preserve are plant communities of local or statewide significance, including the black oak woodland, redwood forest, white alder forest and knobcone pine forest, which provides habitat for listed wildlife species, including potential marbled murrelet and peregrine falcon nesting, and spawning steelhead trout; and

NOW, THEREFORE, BE IT RESOLVED pursuant to Section 5019.50 of the Public Resources Code, and after proceedings in accordance with the Administrative Procedures Act, that the California State Park and Recreation Commission hereby classifies approximately 1800 acres in Castle Rock State Park as a Natural Preserve and names the unit San Lorenzo Headwaters Natural Preserve.

GENERAL PLAN INQUIRIES

The California Department of Parks and Recreation Northern Service Center prepared the Castle Rock SP General Plan Amendment. For general information regarding this document or the approved general plan for Castle Rock State Park, please contact the Northern Service Center or Santa Cruz District Office:

California Department of Parks and Recreation
Northern Service Center
1725 23rd Street, Suite 200
Sacramento, California 95816
Phone: (916) 324-0077
Fax: (916) 324-0888

Santa Cruz District Office
Mountain Sector Headquarters
600 Ocean Street
Santa Cruz, California 95060
Phone: (831) 429-2850
Fax: (831) 429-2876

**Appendix I
Settlement Agreement
July 25, 2003**

BILL LOCKYER
Attorney General

State of California
DEPARTMENT OF JUSTICE

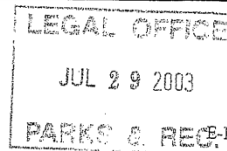

1300 I STREET, SUITE 125
P.O. BOX 944255
SACRAMENTO, CA 94244-2550

Telephone: (916) 323-3549
Facsimile: (916) 327-2319
E-Mail: Deborah.Wordham@doj.ca.gov

July 25, 2003

Deborah A. Sivas, Esq.
Earthjustice Legal Defense Fund
Owen House
553 Salvatierra Walk
Stanford, CA 94305-8610

Re: *Sierra Club, et al. v. Department of Parks and Recreation*
Sacramento Superior Court Case No. 00CS01235

Dear Ms. Sivas:

I am enclosing for your files your copy of the Settlement Agreement executed by Ruth Coleman, Acting Director for the Department of Parks and Recreation, and approved as to form by myself.

I am also enclosing a copy of the Stipulated Dismissal which is being filed in Sacramento Superior Court today. I have attached to the Stipulated Dismissal for the court's reference a copy of the fully executed Settlement Agreement. A conformed copy of the Stipulated Dismissal will be forwarded to your office as soon as we receive it.

Thank you for your cooperation and assistance in resolving this matter.

Sincerely,

DEBORAH A. WORDHAM
Deputy Attorney General

For BILL LOCKYER
Attorney General

DAW:

cc: ~~Tim~~ LaFranchi, Esq., Chief Counsel, Dept. of Parks and Recreation
Dave Keck, Manager

*** CONFIDENTIAL SETTLEMENT DOCUMENT ***

**Sierra Club, et al. v. Department of Parks and Recreation, Sacramento
Superior Court No. 00CS01235 (Castle Rock Park Litigation)**

WHEREAS, the Department of Parks and Recreation (Department) and the State Parks and Recreation Commission (jointly referred to as the State) adopted and approved a General Plan and General Plan Amendment for Castle Rock State Park which proposes various improvements within the Park, including parking spaces, visitor and administrative facilities, and camp sites;

WHEREAS, the Sierra Club and Friends of Castle Rock State Park (jointly referred to as the Sierra Club) filed suit, *Sierra Club, et al. v. California Department of Parks and Recreation, et al.*, Sacramento Superior Court Case No. 00CS01235 (the "litigation"), alleging that the adoption of the General Plan for Castle Rock State Park did not comply with the California Environmental Quality Act (CEQA) or with certain sections of the Public Resources Code relating to the determination of carrying capacity of the Park;

WHEREAS, the State contends that it met all applicable legal requirements;

WHEREAS, the State will be engaged in further planning and analysis of the site and the improvements described in the General Plan for Castle Rock State Park;

WHEREAS, the State and the Sierra Club believe that analytical processes can be undertaken that will provide planning information that will satisfy the concerns and objectives of all parties and which will permit appropriate site planning and development;

WHEREAS, if these analytical processes satisfy both the Sierra Club and the State, the parties can avoid the expense and uncertainty of litigation.

NOW THEREFORE, the Sierra Club and the State agree as follows:

1. Resource Advisory Committee
 - a. The Department shall establish a Resource Advisory Committee (RAC) of independent scientists, who meet the qualifications set forth below at paragraph 1.e., to provide the Department with input as to (1) the carrying capacity methodology being developed by the Department as set forth below in paragraph 2, and (2) the scope of information that is available for the Santa Cruz Mountain Regional Inventory being developed by the Department as set forth below in paragraph 3. The Department shall have the discretion whether to solicit comments from the RAC on other, related issues, such as any future proposed development and uses at state parks within the Santa Cruz Mountains Region.

- b. The RAC shall be established as follows:
 - i. The RAC shall be composed of five (5) members who meet the minimum qualifications, as set forth below at paragraph 1.e.
 - ii. Within 60 days of the dismissal of the litigation following execution of this settlement agreement, the Department shall invite all interested persons, including the Sierra Club, to submit the name(s) of any person(s) who meets the minimum qualifications for membership on the RAC. Interested persons shall have 30 days in which to nominate persons for membership on the RAC.
 - iii. Within 30 days of the last date on which names may be submitted for membership on the RAC, the Department shall review the nominations and approve what it believes are the five (5) most qualified nominees.
 - iv. In the event that a vacancy occurs during the existence of the RAC, the Director or his/her designee shall have the authority to fill the vacancy from the list of persons initially submitted to the Department or from any subsequent list of qualified candidates submitted to the Department.
- c. The RAC shall function independently of the Department, and the Department shall have no obligation to manage, coordinate or meet with the RAC, but may do so solely at the Department's discretion.
- d. Members of the RAC shall be responsible for establishing its internal structure and process for meeting, debating and reviewing information and providing comments to the Department.
- e. Minimum Qualifications: Members of the RAC shall (1) have demonstrable competence in conservation biology as evidenced by formal training (a graduate or post-graduate degree in biology and/or conservation), or equivalent experience (research and scholarly publication within the field of conservation biology);(2) have no personal stake in the outcome of the RAC's work, in terms of financial gain or loss, career advancement, or personal or professional relationship; (3) be able to perform the review tasks free of intimidation or forceful persuasion by others associated with the decision process; (4) be willing to use his or her scientific expertise to reach objective conclusions that may be discordant with his or her value systems or personal biases; and (5) be willing and able to help identify internal and external costs and benefits, both social and ecological, of alternatives decisions. Persons with specialized knowledge of the Santa Cruz Mountain Region shall be given special consideration for the RAC.

- f. During the planning process for the development of Castle Rock State Park, the Department shall solicit comments from the RAC at the same time and in the same manner as it solicits comments from responsible and trustee agencies and from members of the public. The Department shall make available to the RAC any existing information, studies and data. The Department shall have no obligation to develop any new or additional information or to fund any studies to develop new information.

2. Carrying Capacity Survey

The Department is in the process of preparing a methodology, an adaptive management approach, for carrying capacity surveys for state parks. The Department shall apply that methodology to any future development and subsequent management plan of Castle Rock State Park. The Department agrees to provide a copy of the methodology developed to the Sierra Club prior to its implementation at Castle Rock State Park.

3. Regional Inventory Process

The Department acknowledges that resources in the Santa Cruz Mountain state parks have or may have regional interconnectivity. In recognition of the potential impact of development in one park unit on sensitive species in other park units, the Department agrees to map the habitat of sensitive species, using data currently available through state agencies, local agencies, and other governmental entities, as well as other scientifically credible information provided to the Department for consideration by the Sierra Club. This Regional Inventory shall cover the Santa Cruz Mountain region, as shown on Exhibit A attached hereto and shall be used in planning, impact analysis, and management of park units in the Santa Cruz Mountain Region. The Department shall use its best efforts to consolidate this resource inventory into a regional database, including GIS mapping of significant habitat, based on available funding and staffing resources, and make this information available to the public via the Department's website.

Specific resources to be mapped shall include: 1) known marbled murrelet habitat, whether or not occupied; 2) mountain lion habitat, whether or not occupied; 3) knobcone pines; 4) Black Oak woodland; 5) ancient redwood forest; 6) riparian areas; and 7) maritime chaparral.

4. Alternatives to Partridge Farm Development

- a. During the environmental review process required by CEQA for campsite and parking development in the Partridge Farm area of Castle Rock State Park, the Department agrees to evaluate at least two alternative locations for the campsites and two alternative locations for the parking lot.

- b. Consideration of alternative locations for the campsites and parking lot shall not preclude the Department from considering and discussing other alternatives at the Partridge Farm site.
 - c. The Department and the Sierra Club recognize that an amendment to the Castle Rock State Park General Plan would be required should the Department determine that a selected alternative is not currently authorized by the General Plan. In the event a general plan amendment is required, the Department shall not be required to reconsider wilderness classifications or reopen the land use planning process for Castle Rock State Park. Agreement that the Department shall not be required to reconsider wilderness classification or to reopen the land use planning process shall not be construed as a waiver of or limitation on the Sierra Club's rights to challenge the Department's final decision with respect to the development of Partridge Farm.
5. The Sierra Club shall dismiss its lawsuit with prejudice. The Sierra Club shall retain the right to file a subsequent lawsuit to enforce the terms of this agreement and the outcome of any future site-specific or general development proposal.
 6. The parties agree that nothing in this agreement shall be deemed as an admission of any allegation made in the litigation or as an admission of liability.
 7. Each party shall bear its own attorney fees, legal expenses and costs of suit arising out of this lawsuit.

APPROVED AS TO FORM:

Date: July 15, 2003

BILL LOCKYER, ATTORNEY GENERAL

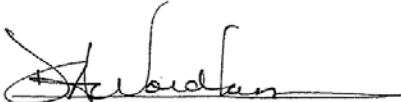
By: 
Deborah A. Wordham,
Deputy Attorney General, Attorney for
Department of Parks and Recreation

Date: 6/27/03

By: 
Deborah A. Sivas, EarthJustice
Attorney for Sierra Club, Friends of
Castle Rock State Park

EXHIBIT A

Castle Rock Settlement Agreement SANTA CRUZ MOUNTAINS REGION



Blank page

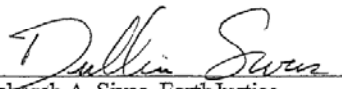
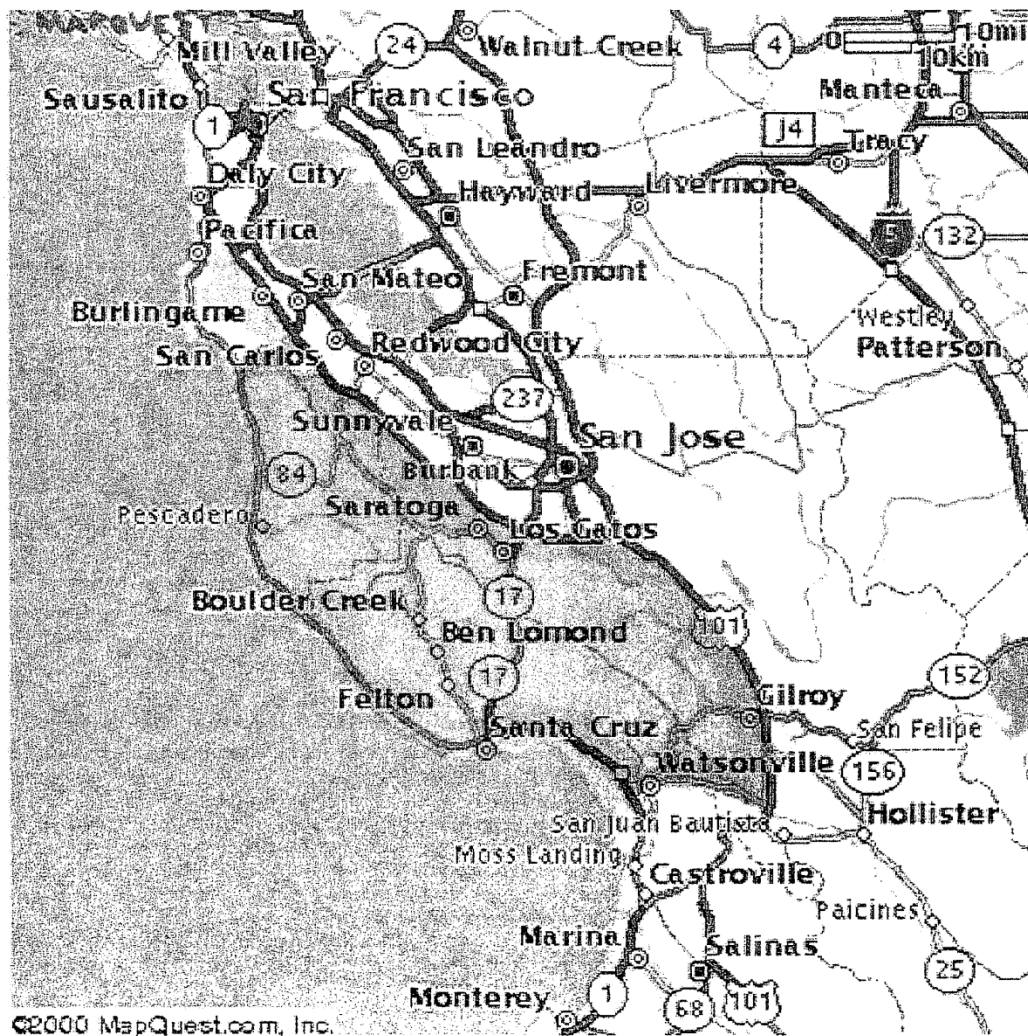

GENERAL PLAN MAPS

Blank side of divider page

This General Plan was prepared by:

Staff of the California State Parks Northern Service Center

Robert Acrea, Sr. Landscape Architect, Supervisor of General Plans
Dan Bell, Associate State Archeologist
Richard Clark, State Park Interpreter II
Dave Keck, Associate Landscape Architect, Project Manager
Roy Martin, Associate State Park Resource Ecologist
George Stammerjohan, State Historian II
Gary Waldron, Associate State Park Resource Ecologist
Robert Ueltzen, Associate Park and Recreation Specialist

Staff of the Santa Cruz District, Mountains Sector, and Castle Rock State Park

Jan Anderson, Santa Cruz Mountains Sector Park Superintendent
Liz Burko, State Park Ranger I
Holly Huenemann, Supervising Ranger
Miles Standish, State Park Ranger I
Steve Radosevich, Santa Cruz District Interpretive Specialist
Dave Vincent, Santa Cruz District Superintendent

Staff of the Planning, Acquisition & Environmental Design Division

Dianne Ambagis, Senior Delineator
Gary Cave, Supervisor of Drafting Services
Myra Liburdy, Senior Delineator

With the Assistance of:

Doug Rischbieter, Associate State Park Resource Ecologist

With special thanks to the members of the Castle Rock Advisory Committee, and the many citizens and organizations who help shape this plan through their participation in the planning workshops and public meetings.