

BLUE WING INN
133 EAST SPAIN STREET
SONOMA STATE HISTORIC PARK
SONOMA, CALIFORNIA 95476

USE PLANNING STUDY
FINAL [I 2004B]





TABLE OF CONTENTS

| | |
|---|-------|
| INTRODUCTION | 1 |
| General Information..... | 1 |
| Use Matrices..... | 2 |
| Table 1: Occupancy & Egress..... | 2 |
| Table 2: Improvements | 3 |
| USE PLANNING..... | 5 |
| Site Plan & General Strategies..... | 5 |
| Use 1: Lodging..... | 8-9 |
| Use 2: Historic House Museum | 10-11 |
| Use 3: Offices | 12-13 |
| Use 4: Events, Restaurant & Retail (mixed-use)..... | 14-15 |

INTRODUCTION

USE PLANNING:
SITE PLAN

USE PLANNING 1:
LODGING

USE PLANNING 2:
HOUSE MUSEUM

USE PLANNING 3:
OFFICES

USE PLANNING 4:
EVENTS & RETAIL

INTRODUCTION

GENERAL INFORMATION

The purpose of this Use Study is to supplement the upcoming project of restoration of the Blue Wing Inn, a circa-1830 unreinforced two-story historic adobe building in Sonoma State Park, located in Sonoma, California. The building consists of adobe exterior walls, wood second floor framing, wood frame roof, second story wood frame porches with single exit from second floor, stone rubble foundation with first floor at grade. Total building square footage is approximately 4,676 SF gross, or 4,532 SF net. The building footprint is approximately 101' x 20' with 6'-6" wide porches along the north and south adobe walls. The primary project involves reroofing and seismic strengthening of the structure, upgrades of roof framing, repairs of deteriorated wood members and improvements to the wall-to-roof connections. The Use Study is a summary of the proposed uses suggested by the Department of Parks and Recreation (DPR) and discussed in previously prepared reports¹, as well as Page & Turnbull's evaluation of the proposed uses for their compatibility with the building and impacts to the historic fabric based on applicable building codes associated with each use. The last use was residential apartments vacated in 2001. Structural impacts were taken into account based on discussions with Michael Krakower Structural Engineers. The team studied available documents and attended a site visit to further assess the current condition of the building.

Goals: Rehabilitation (adaptive reuse) based on Secretary of Interiors Standards, SHBC, Title 24 & occupancy compatible with building type and to provide a revenue stream.

Interpretive goals for the property can be met and reinforced by compatible uses and partnerships. Should a partnership be solicited, there should be an awareness of code requirements and associated scope/costs.

¹ Blue Wing Inn, Architectural Condition Assessment & Recommendations Report. Jennifer Korge, Associate Architect. September 2003.
Blue Wing Inn, Sonoma, California, Historic Structure Report, Page & Turnbull, Inc. July 24, 2002.



Photograph A: Blue Wing Inn, south elevation from courtyard, 2002.



Photograph B: Blue Wing Inn, ground level interior, 2002.

The project team includes:

CLIENT

Department of Parks & Recreation - State of California
Contact: Maria Baranowski, Shelly Dildey
Northern Service Center
One Capital Mall, Suite 410
Sacramento, CA 95814
(916) 445-7998
maria.baranowski@parks.ca.gov
shelly.dildey@parks.ca.gov

PRESERVATION ARCHITECT

Page & Turnbull, Inc.
Contact: Tom Dufurrena, Lada Kocherovsky
1000 Sansome, Suite 200
San Francisco, CA 94111
(415) 362-5154
dufurrena@page-turnbull.com
kocherov@page-turnbull.com

STRUCTURAL ENGINEER

Michael Krakower & Associates
Contact: Michael Krakower
160 White Oak Drive
Arcadia, CA 91006
(626) 355-6088
mkcase@verizon.net

COST ESTIMATOR

J.R.Conkey & Associates
Contact: Scott Ransdell
735 Sunrise Avenue, Suite 200
Roseville CA 95661
(916) 783-3277
SRansdell@jrconkey.com

USE MATRICES

Six principal uses, and respective constraints for each, have been identified by DPR as potential compatible uses:

- 1. Lodging or Housing:** Use is most consistent with maintaining the uniquely authentic experience, and keeps within the original history and use of the building. Lodging could be a boutique hotel; housing could maintain the use as apartments. Proposed use would include both floors.
- 2. Historic House Museum:** Potentially allows for least changes to historic fabric, but lacks revenue stream
- 3. Offices:** Two levels of leasable Office space
- 4. Events Venue A:** ground floor Exhibition & Conference space with leasable Offices above
- 5. Events Venue B:** ground floor Exhibition & Conference space with Residential apartments above
- 6. Retail and Restaurant:** ground floor Mixed-Use spaces with leasable Offices above

For the purposes of this study, potential building uses were grouped into two categories: single occupancies and mixed occupancies. Each of the single occupancies was analyzed based on the applicable CBC requirements for egress; for mixed uses occupancies, one (*Commercial A: Restaurant & Retail*) was analyzed as a representative example. Refer to Table 1, *Occupancy and Egress*. Table 2, *Improvements*, summarizes structural and systems upgrade requirements, life safety, including fire separations, accessibility and practical considerations, such as additional structures on the site, related to each use.

TABLE 1 - OCCUPANCY & EGRESS

| | OCCUPANCY | | | | | | | | EGRESS | | | | | | Additional Notes | |
|------------------------|-----------------------------------|------------|-------------|---------------|--------------------------|------------|-------------|---------------|------------------|---------------------------------------|------------------|---------------------------------------|-----------|-----------------------|------------------|--|
| | Level 1 | | | | Level 2 | | | | Level 1 | | | Level 2 | | | | |
| | Occupancy Classification | Area (SF) | Load Factor | Occupant Load | Occupancy Classification | Area (SF) | Load Factor | Occupant Load | Doors & Openings | Min. Door Width Provided ² | Doors & Openings | Min. Door Width Provided ² | Stairways | Stairs Width Provided | | |
| SINGLE USE OCCUPANCIES | Lodging ³ | R-1 R-2 | 1716 | 200 | 10 | R-1 R-2 | 1615 | 200 | 11 | 2 | 33 | 2.2 | 32 | 3.3 | 35 | 1) REQUIRED 1HR. SEPARATION ACHIEVED THROUGH INSTALLATION OF FIRE-SPRINKLERS |
| | House Museum | A3 | 1716 | 15 | 91 | A3 | 1615 | 15 | 102 | 18.2 | 33 | 20.4 | 32 | 30.6 | 35 | 2) OCCUPANT LOAD CAN BE REDUCED WITH DESIGNATION OF SPECIFIC AREAS FOR DISPLAY & DEFEND PUBLIC ACCESS AREAS; WILL REDUCE EGRESS REQUIREMENTS |
| | Offices | B | 1716 | 100 | 19 | B | 1615 | 100 | 18 | 3.8 | 33 | 3.6 | 32 | 5.4 | 35 | |
| MIXED-USE OCCUPANCIES | Events A: Events & Offices | A3 | 1716 | 15 | 91 | B | 1615 | 100 | 18 | 18.2 | 33 | 3.6 | 32 | 5.4 | 35 | 3) INSTALLATION OF FIRE-SPRINKERS ALLOWS FOR "NON-SEPARATED MIXED-USE" BUILDING CLASSIFICATION (GOVERNED BY GROUP A RESTRICTIONS) ⁴ |
| | Events B: Events & Lodging | A3 | 1716 | 15 | 91 | R-1 R-2 | 1615 | 200 | 11 | 18.2 | 33 | 2.2 | 32 | 3.3 | 35 | SEE 3) |
| | Commercial A: Restaurant & Retail | M A2 | 690 1026 | 30 15 | 18 58 | B | 1615 | 100 | 18 | 3.6 11.6 | 33 | 3.6 | 32 | 5.4 | 35 | SEE 3) |
| | Commercial B: Retail | M | 1716 | 30 | 49 | B | 1615 | 100 | 18 | 9.8 | 33 | 3.6 | 32 | 5.4 | 35 | SEE 3) |

STRUCTURAL REQUIREMENTS:

Allowable Live Loads for:

Lodging: 40 PSF

Offices: 50 PSF+ 15 PSF minimum for partitions

Retail/Assembly/Museum/Exits: 100PSF

Estimated average live load capacity of second floor joists (2003 Report):

Above Room 103&104: Below 40 PSF

Above Room 105: Below 50 PSF

Porch Edge Beams: 40 PSF

Porch Joists: 114 PSF

Stair Stringers: 80 PSF

Structural Needs:

- Any re-use option necessitates strengthening interior floor joists in general.
- Porches need only the edge beams strengthened.
- Replace or supplement any deteriorated framing anywhere.
- Slope variation of second level flooring would need to be addressed based on accessibility requirements applicable to the selected use.

Structural Strategies:

- Easiest strengthening technique is attaching new joists to sides of existing joists.
- New added joists can stop at face of existing adobe walls.
- Seismic strengthening can be hidden between new and existing joists.
- Second floor decking can be built up from above or below to mitigate level changes.

TABLE NOTES:

- 1) All calculations rounded up to nearest whole number. Square footage does not include second level porches.
- 2) Chart denotes narrowest clear width provided. Majority of existing doors meet or exceed minimum width requirements for egress; doors requiring modification noted on individual use plans. See "Improvements" matrix for general accessibility compliance requirements.
- 3) Difference between Group R-1/R-2 not expounded in this study.
- 4) Restrictions pertain to fire separation requirements. Egress widths & related calculations governed by room use classification.

TABLE 2 - IMPROVEMENTS

| | STRUCTURAL UPGRADES | | | | | LIFE SAFETY | | | | | SYSTEMS ⁵ | | | | | | | ACCESSIBILITY | | | | | ADDITIONAL ITEMS | COST | | | | |
|------------------------|-----------------------------------|---------------------|-----------------|--------------------|-----------------|-------------|----------------------|----------------|----------------------|-------|-----------------------------|------------------|------------|----------------|----------------|----------------|-------------------|----------------|--------------------|-------------|-----------------|-----------|------------------|---|---|--|---------------------|---------|
| | Re-Roofing | Seismic Top of Wall | Reinforce Floor | Seismic Mid-Height | Reinforce Porch | Exits Req'd | Rebuild Exist. Stair | Second Stair | Occupancy Separation | | Fire Protected Construction | | Electrical | | HVAC | | Plumbing | | Central Mech. Area | Door Access | Elevator / Lift | Bathrooms | | | Handrail Modifications | Parking | Additional Upgrades | |
| | | | | | | | | | Needed | Type | Fire Protected Construction | Fire Suppression | Removal | Re-wiring | Removal | Reinstallation | Removal | Reinstallation | | | | Level 1 | | | | | | Level 2 |
| SINGLE USE OCCUPANCIES | Lodging | X | X | | X | | | X ² | 1hr. | | | X | X | X | X | X | X ⁶ | | X | | X | | | | | LINEN STORAGE, MAINTENANCE, OFFICE (LEASING, ETC.) | | |
| | House Museum | X | X | | X | | X | | | | | X | X | X ⁷ | X ⁷ | X | X ⁷ | | X | X | X | | | SECOND LEVEL PORCHES ADJUSTED FOR COMPLIANT CROSS-SLOPE | ADDITIONAL PUBLIC RESTROOMS STRUCTURE WITHIN COURTYARD | | | |
| | Offices | X | X | | X | | X | | | | | X | X | X | X | X | X ⁸ | | X | | X | | X | | | ADDITIONAL PUBLIC RESTROOMS STRUCTURE WITHIN COURTYARD | | |
| MIXED-USE OCCUPANCIES | Events A: Events & Offices | X | X | | X | | X | | 4 | | | X | X | X | X | X | X ^{8,9} | | X | X | X | | X | | SECOND LEVEL PORCHES ADJUSTED FOR COMPLIANT CROSS-SLOPE | ADDITIONAL PUBLIC RESTROOMS STRUCTURE WITHIN COURTYARD | | |
| | Events B: Events & Lodging | X | X | | X | | X | | X ^{3,4} | 1 hr. | | X | X | X | X | X | X ^{8,10} | | X | X | X | X | X | | SECOND LEVEL PORCHES ADJUSTED FOR COMPLIANT CROSS-SLOPE | ADDITIONAL PUBLIC RESTROOMS STRUCTURE WITHIN COURTYARD | | |
| | Commercial A: Restaurant & Retail | X | X | | X | | X | | 4 | | | X | X | X | X | X | X ^{8,9} | | X | X | X | | X | | SECOND LEVEL PORCHES ADJUSTED FOR COMPLIANT CROSS-SLOPE | KITCHEN (SIZE/EQUIPMENT DEPENDING ON SCOPE OF NEEDS); ADDITIONAL PUBLIC RESTROOMS STRUCTURE WITHIN COURTYARD | | |
| | Commercial B: Retail | X | X | | X | | X | | 4 | | | X | X | X | X | X | X ^{8,9} | | X | X | X | | X | | SECOND LEVEL PORCHES ADJUSTED FOR COMPLIANT CROSS-SLOPE | ADDITIONAL PUBLIC RESTROOMS STRUCTURE WITHIN COURTYARD | | |

Two principal upgrades were universally applied and allow for the maximum flexibility of the structure:

1. Installation of an automated sprinkler system throughout the building.
2. Removal of all existing building systems (mechanical, electrical, plumbing, etc.), coupled with the installation of any new building systems, as applicable.

While connections to the existing utilities still need to be confirmed, the approach to upgrading both fire protection and mechanical systems would be to minimize the impacts to the existing structure to the extent possible. Fire sprinkler distribution for the second floor would be concealed in the attic space, with required number of sprinkler heads penetrating existing plaster ceiling. Ground floor rooms would likely require surface-mounted main branch lines along the interior face of the load bearing masonry walls with side-mounted sprinkler heads. Note that full engineering assessment is needed to validate these assumptions.

Additional accessibility strategies are discussed in both the "Site Plan & General Strategies" and "Accessibility Upgrades at Second Level" sections.

TABLE NOTES:

- 1) Single stair egress may be granted under Historic Building Code. For "House Museum" option, a single stair would require lowering occupancy load of second level to 49 or less.
- 2) Fire separation required A) between individual units, & B) between units and adjacent other occupancies if not considered adjacent spaces (lobby, commons, etc.). Fires separation can be lowered to 1/2hr. rating between dwelling / sleeping units with installation of fire sprinklers.
- 3) Building to be classified as "Non-Separated Mixed-Use" occupancy & governed by Group A restrictions.
- 4) An exception to Note 3: any mixed-use occupancy requires additional 1 hr. separation between Group R & adjacent occupancies.

- 5) All existing building systems to be removed & reinstalled as surface-mounted or to be concealed in new walls, as applicable. Location of existing pipe wall penetrations to be reused where feasible.
- 6) Location of existing bathrooms/kitchens may be reused. Provide updated facilities as required for each occupancy; see individual use occupancy diagrams.
- 7) Re-installation of all systems will be in accordance with Period of Significance. Feasibility of passive-design techniques to be evaluated, as needed.
- 8) To explore potential for new public restrooms to be located within accessory structure within existing courtyard. Provisions for full ADA compliance as required.
- 9) Provide accessibility for at least one (1) room on second level unless equal facilities provided at ground level (on or off-site).
- 10) One (1) guestroom on second level to be fully accessible unless equal facilities provided at ground level (on or off-site).

USE PLANNING

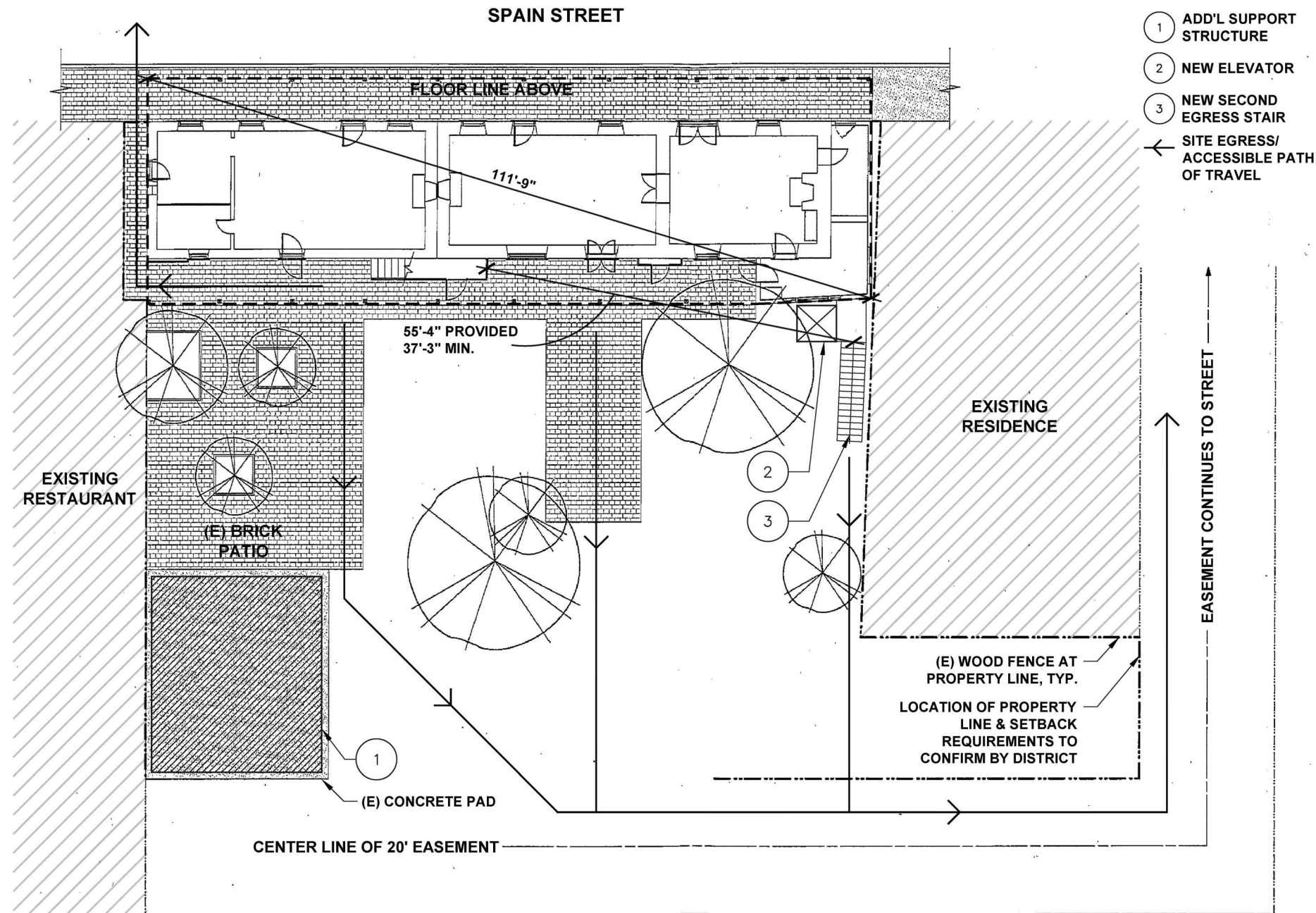

SITE PLAN & GENERAL STRATEGIES

The project site is located to the northeast of Sonoma's historic square, and across the street from Mission San Francisco Solano de Sonoma. The primary approach to the building is along East Spain Street, which is paved with brick. North elevation faces the street, while south elevation looks onto an open courtyard, partially paved with brick and partially covered in vegetation.

Each use considered identifies circulation and egress patterns as required by the building codes and accessibility standards. All uses considered in this study would require access to the courtyard from the street. In its present condition, the courtyard paving is extremely uneven and creates tripping hazards. To address accessibility requirements, a portion of the existing courtyard along the path of travel should be repaved to create a smooth surface minimum of four foot wide. Existing brick should be used and reset to meet the maximum slopes and cross slopes as required to achieve access compliance. Additionally, the surface of the brick walk should be set such that the existing door thresholds are not in excess of 1/4" in height. The location of the path within the courtyard should consider archeological resources discussed in earlier studies to minimize potential impacts.

The site plan diagram identifies locations of a possible supporting structure and elements of new construction that might be triggered by building code requirements. Should a new supporting structure be required, (refer to each use for recommendations), the most appropriate location appears to be on the existing concrete pad in the southwest corner of the site (see keynote 1). Depending on the use type, the supporting structure may include: a) public restrooms; b) kitchen support facility (equipment and services); c) office or general storage facility.

Additionally, most uses will require a second means of egress from the upper level of the building. Currently, one exterior stair provides egress the second floor; however, it doesn't meet the requirement for consistency of the rise/run, and the height/configuration of the railings. The placement of the second stair needs to be determined based on the minimum separation requirements as defined in Chapter 10 of the 2010 CBC. The most appropriate location that satisfies this requirement would be the southeast corner of the building, along the eastern property line.

Lastly, we identified a possible location of an elevator, adjacent to the new exit stair. However, providing accessibility to the second floor of the building would impact the character of the existing historic resource, as substantial modifications to the floor framing, porch framing and door openings would be needed. We recommend selecting uses that would provide accessible features at the ground level only, and allowing upper level to retain its rustic appearance. This approach

USE PLANNING:
SITE PLAN

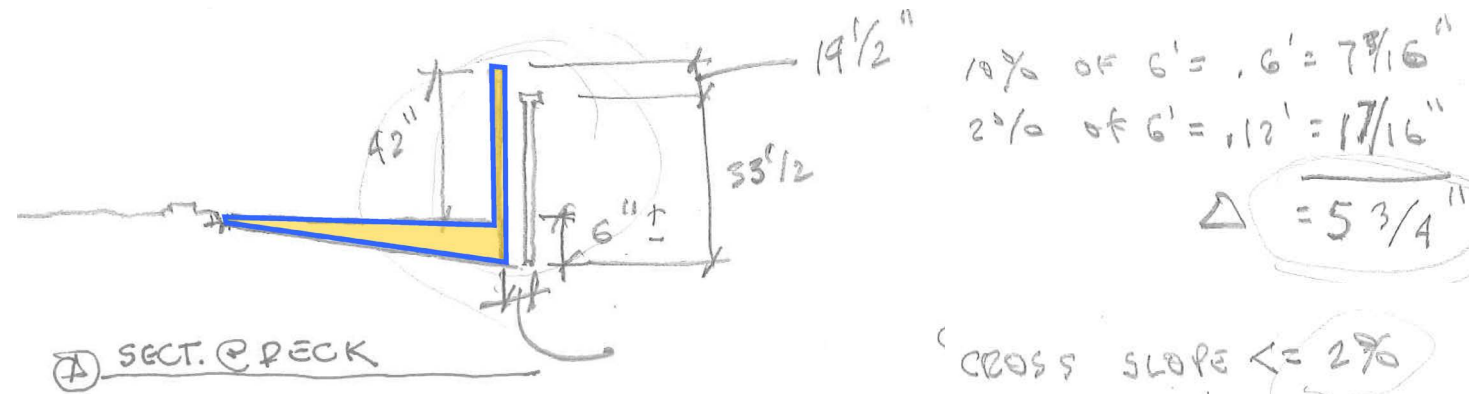
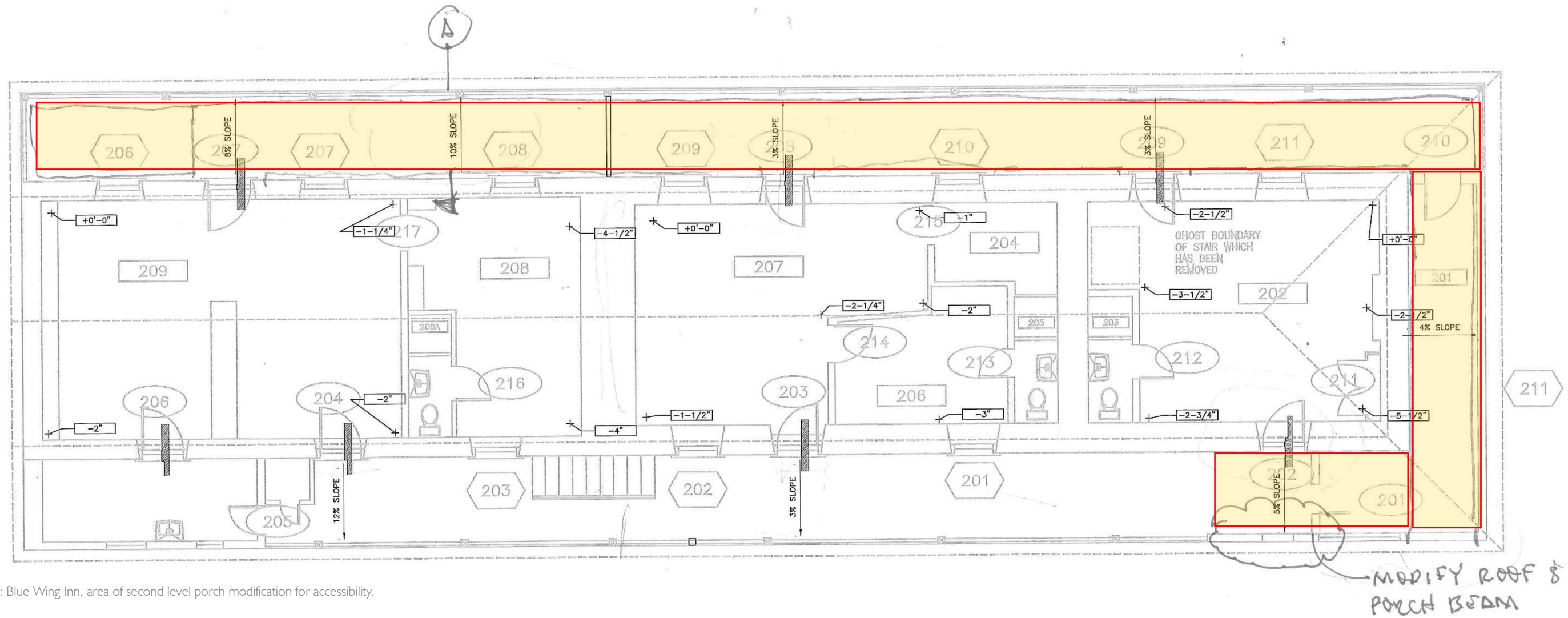

Section A: Blue Wing Inn, second level porch level adjustments.



Photograph C: Blue Wing Inn, interior at second level porch at southwest corner. Area of proposed new egress stair & elevator. 2013.

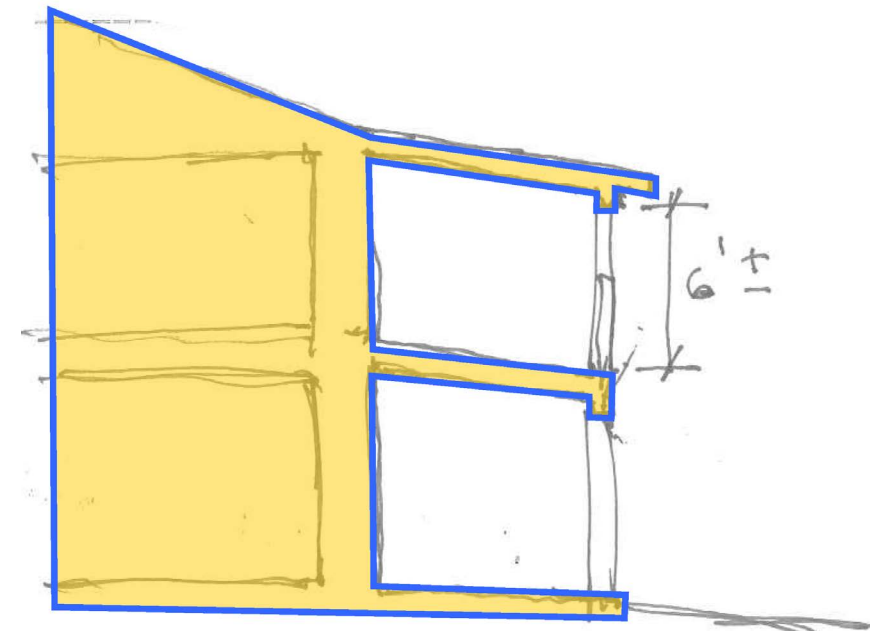

Section B: Blue Wing Inn, porch head clearance diagram.



Photograph D: Blue Wing Inn, exterior at southeast corner. Area of proposed new egress stair & elevator. 2013.

would need to be discussed and agreed upon with the State Parks access compliance reviewer.

Note that the precise location of the property lines has not been determined and is pending completion of the boundary survey. Required setbacks have not been confirmed.

Accessibility Upgrades at Second Level

Should the selected use require public access to the second floor, a new elevator would be needed to provide access to persons with disabilities. As the surface of the second floor porches is uneven and is sloped significantly away from the building, alterations to the existing porch would be needed to mitigate the excessive slopes and cross slopes. The floor plan sketch (see opposing page) demonstrates the extent of the existing porches to be altered, indicated by the highlighted areas. It is preferred that modifications are “additive” and do not permanently damage existing decking and framing. Section A illustrates the proposed conceptual solution which includes a tapered decking and a new railing system that meets current code requirements. The solution might create an undesired visual impact, but is easily reversible.

Two uses that may not require elevator installation are Lodging, R1 and R2 occupancy group, and Office, B occupancy group, under the assumption that equivalent facilitation (e.g. accessible facilities and features) would be provided at the ground level. For residential occupancies, one unit (apartment or guest room) on the ground level would be designated as fully accessible. For the office use, a ground level office would meet full provisions for accessibility, while others would not; this solution would only be applicable for a single office tenant. Both scenarios must be reviewed and agreed upon by the State Parks access compliance reviewer.

The new egress stair, which is required in all use options, would yield additional impacts to the porch framing and decking, as well as changes to the wood exterior framing and cladding of the eastern addition. Currently, the existing porch roof is supported by joists that rest on a perimeter beam, which spans between the porch columns. The bottom of the beam is approximately 6'-0" above the current floor level (see photographs C & D). This clearance does not meet minimum clear headroom requirements of 6'-8"; therefore, the existing beam/window header will need to be modified, along with the roof joists and deck (see Section B). Alternatively, the new stair may be “pushed” in to the structure, allowing the roof structure above to remain. Although this would impact the ceiling below, this approach might be preferred as it avoids interfering with the roof framing, which is the focus of the first phase of the Blue Wing Inn restoration project.

USE PLANNING : OPTION 1 - LODGING

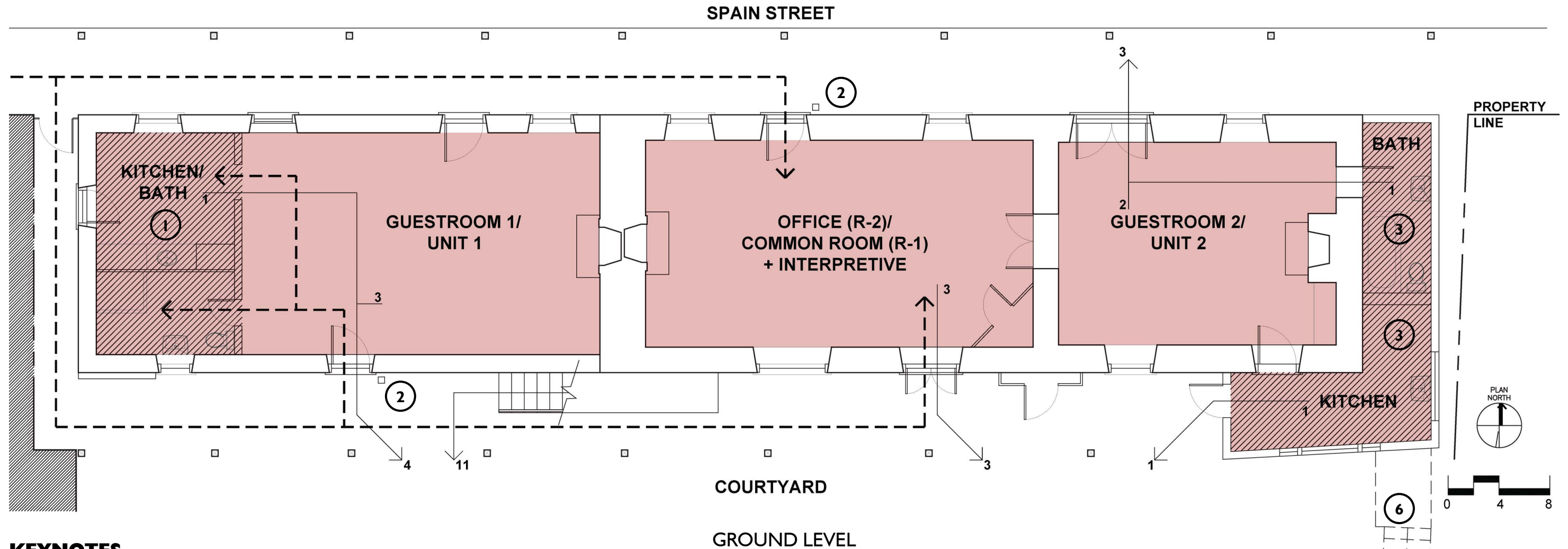

KEYNOTES

1. Accessible bathroom and kitchenette
2. Pedestal-mounted automatic door activator (to be surface mounted)
3. Remove existing fixtures & finishes; replace with new, as needed
4. Enlarge door opening & replace door as required by egress
5. Provide new opening as required by egress
6. New exit stair

LEGEND

- PRIMARY OCCUPANCY
- AREA OF PROPOSED ALTERATION
- EXISTING CONSTRUCTION
- ACCESSIBLE PATH OF TRAVEL
- 4 EGRESS PATH & LOAD

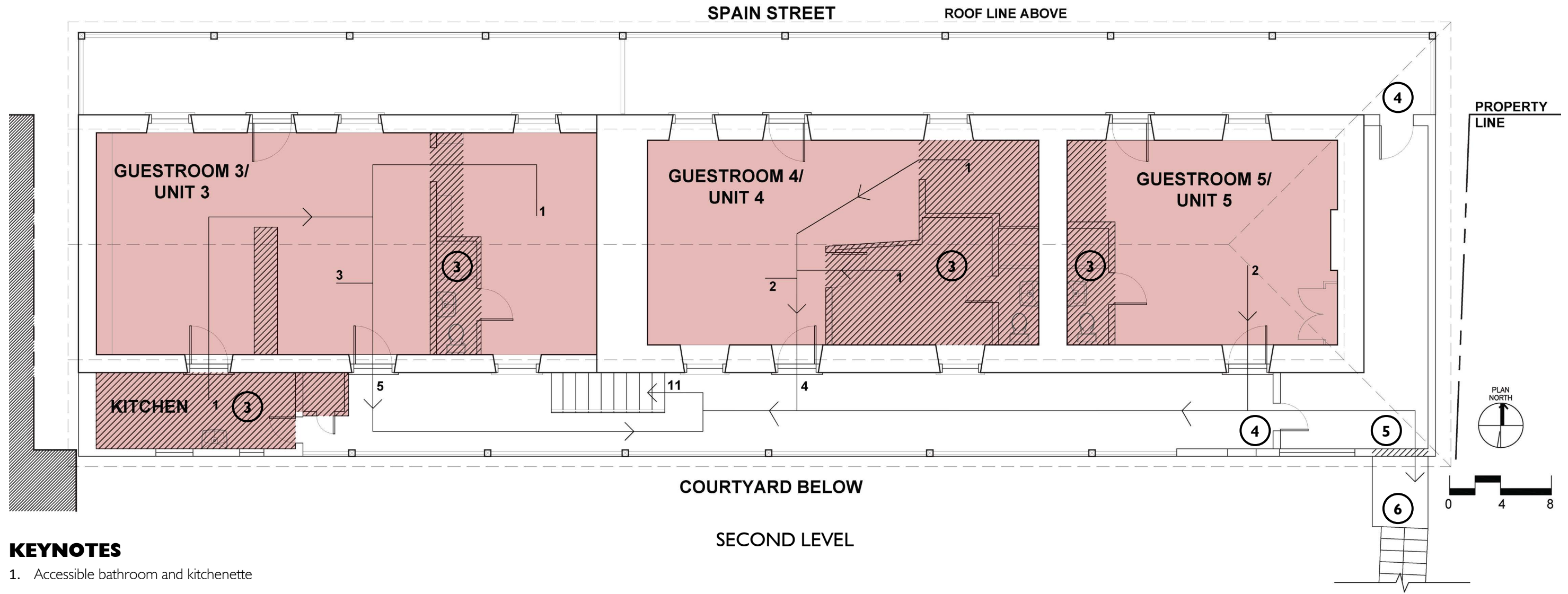

USE PLANNING 1:
LODGING

KEYNOTES

1. Accessible bathroom and kitchenette
2. Pedestal-mounted automatic door activator (to be surface mounted)
3. Remove existing fixtures & finishes; replace with new, as needed
4. Enlarge door opening & replace door as required by egress
5. Provide new opening as required by egress
6. New exit stair

LEGEND

- PRIMARY OCCUPANCY
- AREA OF PROPOSED ALTERATION
- EXISTING CONSTRUCTION
- ACCESSIBLE PATH OF TRAVEL
- 4 EGRESS PATH & LOAD

USE PLANNING : OPTION 2 - HOUSE MUSEUM

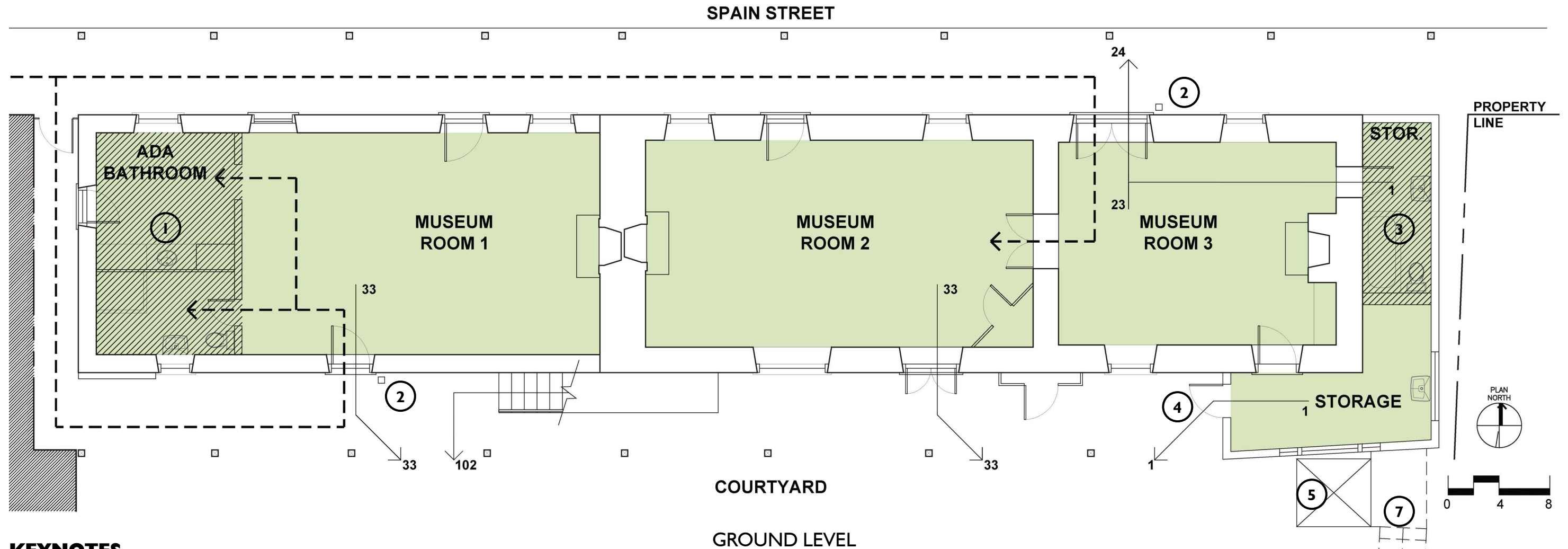

KEYNOTES

1. Accessible restrooms (men's and women's)
2. Pedestal-mounted automatic door activator
3. Remove existing fixtures & finishes; replace with new, as needed
4. Enlarge door opening & replace door as required by egress
5. New elevator, requirement based on occupancy designation (see note 8)
6. Provide new opening as required by egress
7. New exit stair
8. Alternative use: Interpretive Storage (SI), no public access [limits occupent load; may not trigger accessibility upgrade]

LEGEND

- PRIMARY OCCUPANCY
- AREA OF PROPOSED ALTERATION
- EXISTING CONSTRUCTION
- ACCESSIBLE PATH OF TRAVEL
- 4 EGRESS PATH & LOAD

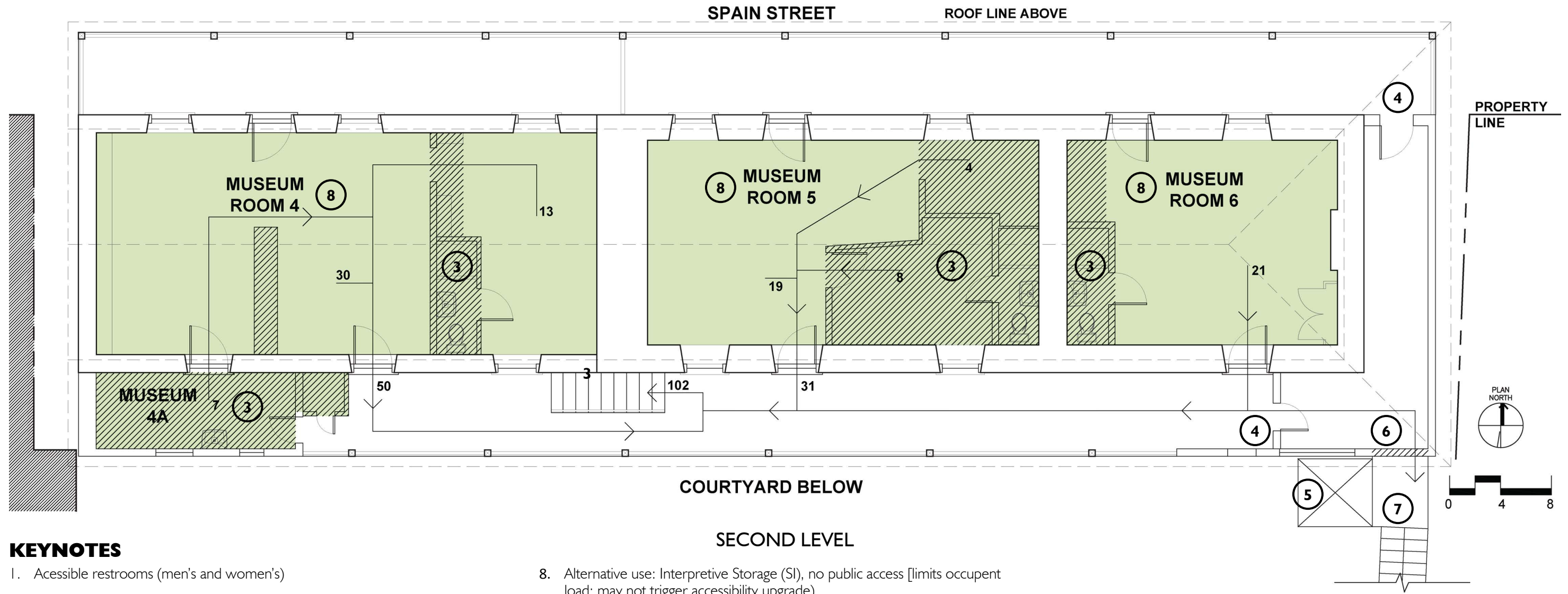

KEYNOTES

- 1. Accessible restrooms (men's and women's)
- 2. Pedestal-mounted automatic door activator
- 3. Remove existing fixtures & finishes; replace with new, as needed
- 4. Enlarge door opening & replace door as required by egress
- 5. New elevator, requirement based on occupancy designation (see note 8)
- 6. Provide new opening as required by egress
- 7. New exit stair
- 8. Alternative use: Interpretive Storage (SI), no public access [limits occupant load; may not trigger accessibility upgrade]

LEGEND

- PRIMARY OCCUPANCY
- AREA OF PROPOSED ALTERATION
- EXISTING CONSTRUCTION
- ACCESSIBLE PATH OF TRAVEL
- 4 EGRESS PATH & LOAD

USE PLANNING 2:
HOUSE MUSEUM

USE PLANNING : OPTION 3- OFFICES

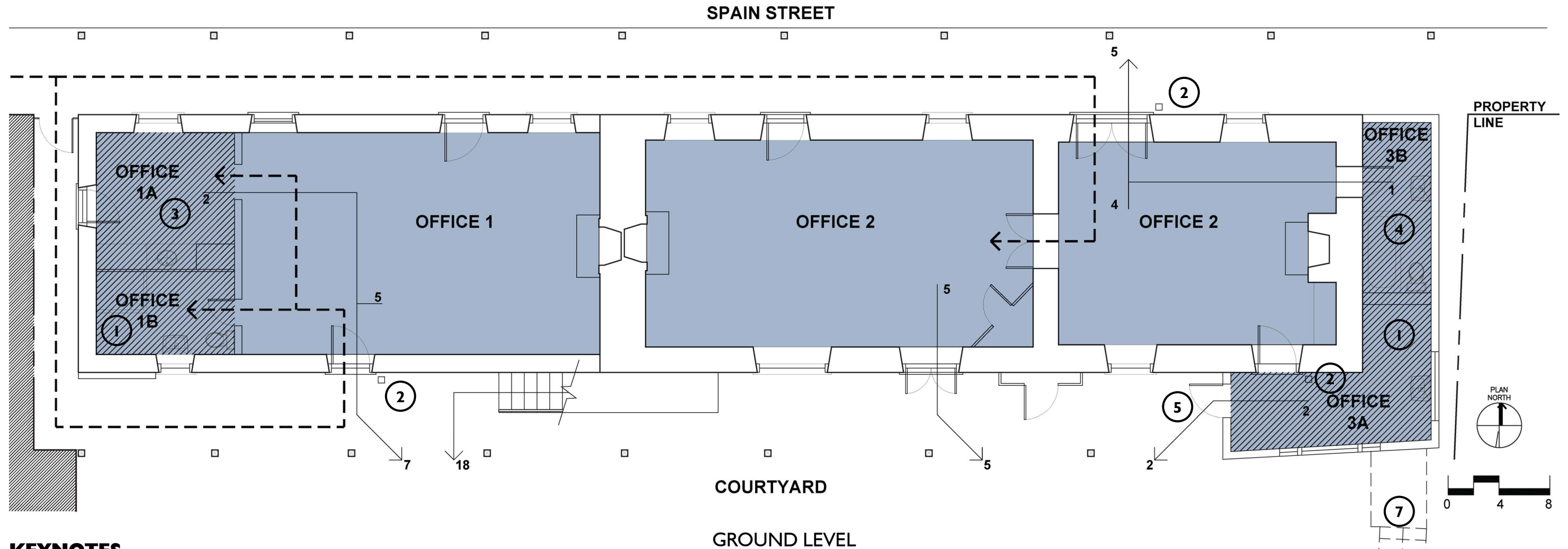

KEYNOTES

- 1. Accessible unisex restroom
- 2. Pedestal-mounted automatic door activator
- 3. New kitchenette
- 4. Remove existing fixtures & finishes; replace with new, as needed
- 5. Enlarge door opening & replace door as required by egress
- 6. Provide new opening as required by egress
- 7. New exit stair
- 8. No accessible facilities at 2nd floor; 1st floor to provide equivalent facilitation for 2nd floor tenants

LEGEND

- PRIMARY OCCUPANCY
- AREA OF PROPOSED ALTERATION
- EXISTING CONSTRUCTION
- ACCESSIBLE PATH OF TRAVEL
- 4 EGRESS PATH & LOAD

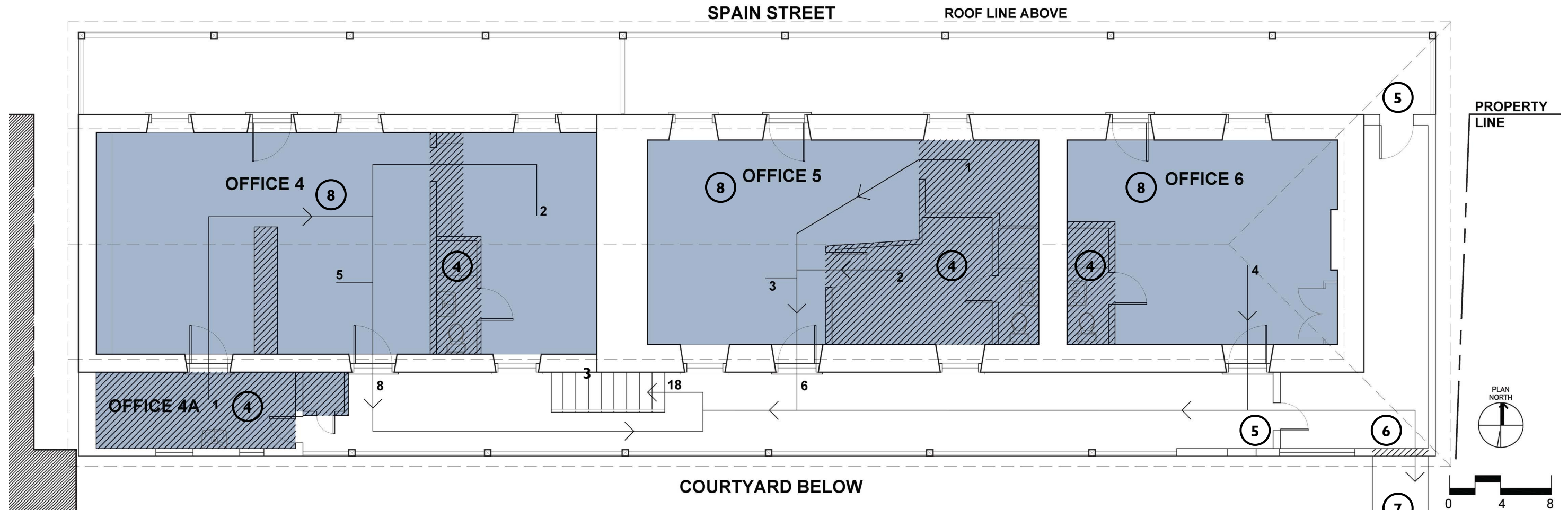

SECOND LEVEL

KEYNOTES

- 1. Accessible unisex restroom
- 2. Pedestal-mounted automatic door activator
- 3. New kitchenette
- 4. Remove existing fixtures & finishes; replace with new, as needed
- 5. Enlarge door opening & replace door as required by egress
- 6. Provide new opening as required by egress
- 7. New exit stair
- 8. No accessible facilities at 2nd floor; 1st floor to provide equivalent facilitation for 2nd floor tenants

LEGEND

- PRIMARY OCCUPANCY
- AREA OF PROPOSED ALTERATION
- EXISTING CONSTRUCTION
- ACCESSIBLE PATH OF TRAVEL
- 4 EGRESS PATH & LOAD

USE PLANNING 3:
OFFICES

USE PLANNING : OPTION 4 - EVENTS, RESTAURANT & RETAIL (MIXED-USE)

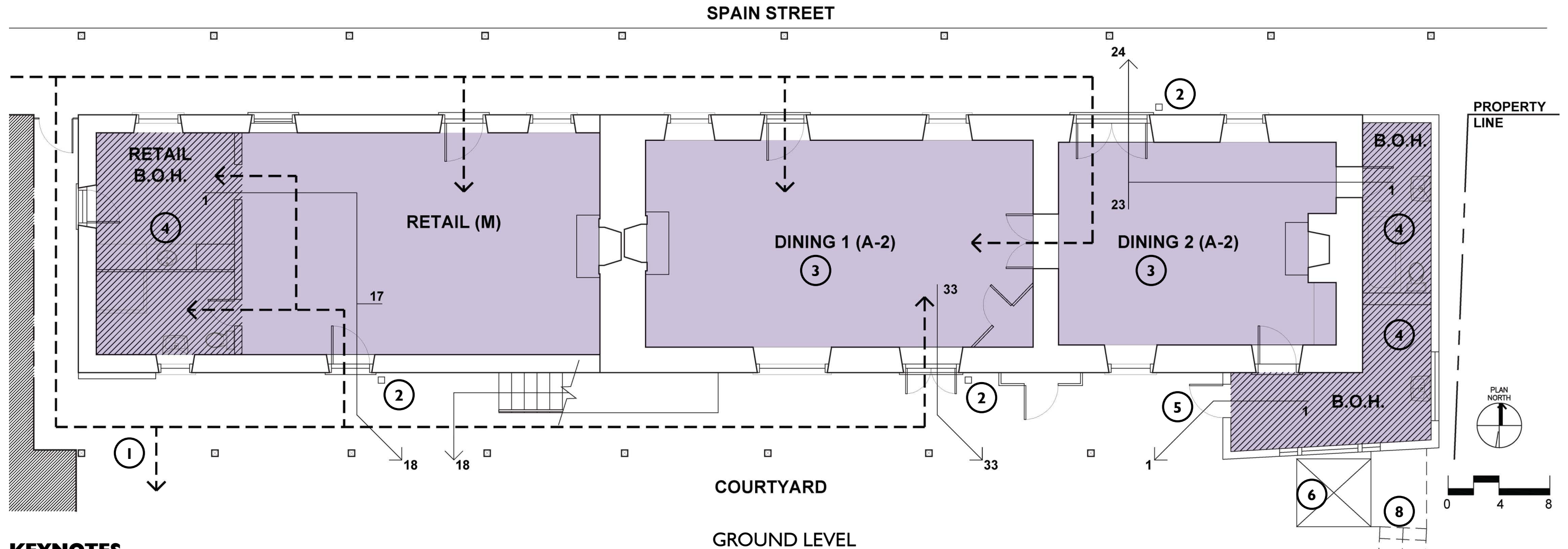

KEYNOTES

1. Accessible restrooms provided in new accessory structure, see site plan for recommended location
2. Pedestal-mounted automatic door activator
3. Separate Dining Facilities at 1st floor; alternative: single A-2 occupancy tenant. Location of food service equipment dependent on size and type
4. Remove existing fixtures & finishes; replace with new, as needed
5. Enlarge door opening & replace door as required by egress
6. New elevator
7. Provide new opening as required for egress
8. New exit stair
9. Accessible restrooms in one location only; assumes single B-occupancy tenant at 2nd floor (alteration to porch floor is required for accessible path of travel compliance)

LEGEND

- PRIMARY OCCUPANCY
- AREA OF PROPOSED ALTERATION
- EXISTING CONSTRUCTION
- ACCESSIBLE PATH OF TRAVEL
- 4 EGRESS PATH & LOAD

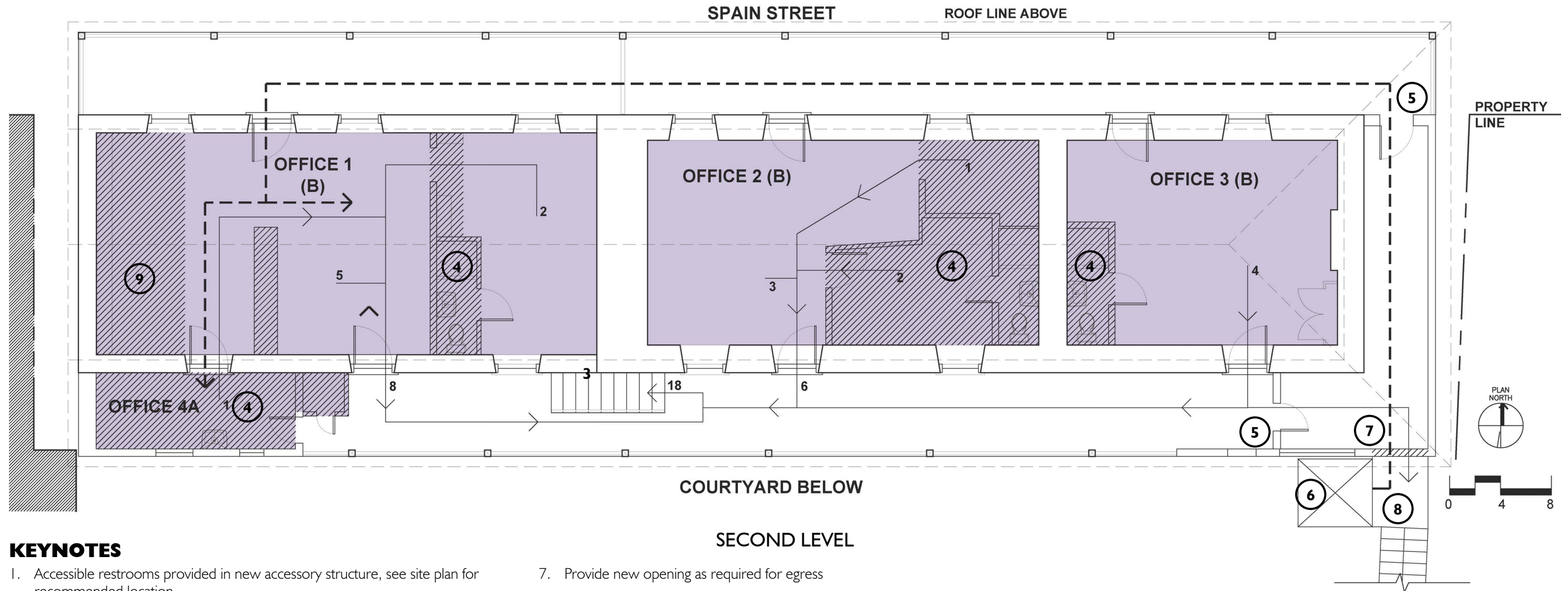

SECOND LEVEL

KEYNOTES

- | | |
|--|---|
| <ol style="list-style-type: none"> 1. Accessible restrooms provided in new accessory structure, see site plan for recommended location 2. Pedestal-mounted automatic door activator 3. Separate Dining Facilities at 1st floor; alternative: single A-2 occupancy tenant. Location of food service equipment dependent on size and type 4. Remove existing fixtures & finishes; replace with new, as needed 5. Enlarge door opening & replace door as required by egress 6. New elevator | <ol style="list-style-type: none"> 7. Provide new opening as required for egress 8. New exit stair 9. Accessible restrooms in one location only; assumes single B-occupancy tenant at 2nd floor (alteration to porch floor is required for accessible path of travel compliance) |
|--|---|

LEGEND

- | | |
|--|------------------------------------|
| | PRIMARY OCCUPANCY |
| | AREA OF PROPOSED ALTERATION |
| | EXISTING CONSTRUCTION |
| | ACCESSIBLE PATH OF TRAVEL |
| | EGRESS PATH & LOAD |

USE PLANNING 4:
EVENTS & RETAIL

ARCHITECTURE
PLANNING & RESEARCH
MATERIALS CONSERVATION

www.page-turnbull.com

1000 Sansome Street, Suite 200
San Francisco, California 94108
415.362.5154 / 415.362.5560 fax

2401 C Street, Suite B
Sacramento, California 95816
916.930.9903 / 916.930.9904 fax

417 S. Hill Street, Suite 211
Los Angeles, California 90013
213.221.1200 / 213.221.1209 fax