



# Resilient Heritage

## Protecting Your Historic Home from Natural Disasters

Developed By:



Funded By:



# Foreword

In Louisiana, the rich diversity of cultures is reflected in myriad building styles located in urban and rural communities across the state. These styles range from vernacular to classical to modern and more. Collectively or singularly, buildings and their characteristic features help to shape our sense of place and reflect cultural changes and influences over time. Recent disasters have set in motion a statewide effort by many agencies to shine a light on educating the public about disaster preparedness. For the Louisiana Division of Historic Preservation (LDHP), our priority is safeguarding historic buildings and properties from natural and man-made disasters.

In a given season, any region of the state may experience disasters resulting from ice storms, thunderstorms, tornados and/or flash flooding, just to name a few. The Louisiana Governor's Office of Homeland Security and Emergency Preparedness (GOHSEP) identified many of these climatological hazards in their recent State Hazard Mitigation Plan Update (2014). This plan is important to the citizens of Louisiana because it provides guidance for reducing or eliminating risks associated with disastrous events. Also, for the first time, GOHSEP has taken into consideration a select group of historic properties to profile for hazard vulnerability. This is an important step for the future of cultural resources and disaster planning in our state because many local and state agencies/organizations utilize this plan as they coordinate mitigation planning and implementation efforts.

This booklet is intended as a continuation of the LDHP and GOHSEP plans to educate the public on disaster resiliency. While owners of historic residential buildings are the target audience, many others can benefit from the information provided here. Implementing the guidance outlined in this booklet will be a key tool in helping to safeguard historic buildings and possibly help prevent repetitive property loss, while maintaining the integrity of the historic building for years to come.

---

This booklet was prepared by the National Park Service's National Center for Preservation Technology & Training (NCPTT) and the Louisiana Division of Historic Preservation (LDHP) to help residential property owners minimize risk and prepare for future disasters, as well as provide critical environmental and historic preservation information to the citizens and leaders of Louisiana. This publication has been funded by the Governor's Office of Homeland Security and Emergency Preparedness (GOHSEP), through the terms of an Interagency Agreement with DHP to implement the Community Education and Outreach (CEO) Program for the Built Environment.

This public document is published at a total cost of \$ 12,720. 3000 copies of this public document were published in this first printing at a cost of \$12,720. The total cost of all printings of this document including reprints is \$12,720. This document was published by University Printing, Northwestern State University, Print Shop 102, Natchitoches, LA 71497 to provide education and information to the citizens and leaders of Louisiana under authority of LA R.S. 25:802(22). Printing of this material was purchased in accordance with the provisions of Title 43 of the Louisiana Revised Statutes.

May 2015

## **Acknowledgments**

Sarah Marie Jackson, Architectural Conservator at the National Center for Preservation Technology & Training in Natchitoches, LA, provided content and layout. Patrick Sparks, Principal and Founder of Sparks Engineering, Inc. provided content and graphics. Cynthia J. Steward, Project Manager, Louisiana Division of Historic Preservation, provided graphics and editing. Edward FitzGerald, Architectural Conservator at the National Center for Preservation Technology & Training in Natchitoches, LA, provided editing and layout.

Special thanks goes to the staff at the National Center for Preservation Technology & Training and Louisiana Division of Historic Preservation for assistance with editing and layout. This publication is not copyrighted and can be reproduced without penalty.

**Cover Image: Historic home in Marksville, La. Image Credit: NPS|Edward FitzGerald**

# Table of Contents

---

Introduction	1
Disasters We Face	5
Building as a System	7
Structural Details	9
Appropriate Materials	11
Hazardous Materials	12
Building Elevation	13
Flood Proofing	16
Drainage	17
Porch & Porch Elements	18
Roofs & Chimneys	19
Windows & Doors	21
Conclusion	25
Glossary	26
Additional Resources	28

## Illustrations & Tables

Wall Section	8
Structural Details	9
Drainage	17
Roof Materials & Styles	20
Window Components	21
Retrofit Comparison	23

# Introduction

Louisiana is susceptible to many types of disasters. According to GOHSEP, the state's location on the Gulf Coast and the Mississippi River watershed, which drains over 40% of the continental U.S., provides little buffer to storms and disasters.

When a disaster strikes, the effects can be far-reaching and the impact may be felt for years. When Hurricane Katrina made landfall along the Gulf Coast on August 29, 2005, the devastation was far greater than anyone expected. In New Orleans, the levees broke, leaving buildings and communities under water for weeks. As the water began to recede and people returned to see the condition of their homes and communities, Hurricane Rita struck, causing more damage and further delaying recovery.

At the time, Hurricane Katrina was the most destructive and costliest natural disaster in United States history. The loss of human life in Louisiana was beyond what anyone imagined possible. Damage to property was apparent on a massive scale. During recovery efforts, preservation organizations realized that there was no difference in how new buildings and historic buildings were treated. Formulas used by insurance companies and government offices to determine whether a damaged building was "beyond repair" made no accommodations for its historic value or significance to a community. In the aftermath of Hurricane Katrina, preservation organizations demanded that historic buildings be evaluated based on historic standards rather than simply the value of their construction materials. Historic buildings are the fabric of communities and have stood the test of time as people, culture, and ways of life have changed.

**Any place on the map can be impacted by a natural disaster.** When a disaster strikes, it can

affect many different aspects of a person's life—family, home, work, schools—all at the same time. Planning ahead can decrease the severity of damage and reduce recovery time.

It is likely that a homeowner will need to plan for or face more than one type of disaster. Hurricanes illustrate this point. For those living near the coast, threats from hurricanes can include tidal forces, flooding, and high winds. People living farther inland may not need to worry about waves, but should prepare for the possibility of tornadoes that are often spawned by a hurricane or high winds. Low-lying areas near a body of water may be at risk for flooding, even if they are not close to the Gulf.

This booklet includes recommendations for ways to better prepare or "harden" historic homes to withstand disasters. In addition to local building codes, there are aesthetic, cost, and accessibility issues that homeowners should consider when making decisions for protecting historic homes. Determining which threats a home may face will aid in deciding which recommendations are applicable. It may be necessary to develop a prioritized plan that requires multiple years to complete.

As a country, we acknowledge that historic homes have value and character not often found in new buildings. The National Register of Historic Places lists historic buildings, archeological sites, and landscapes recognized by the American people for their significance. State and local preservation groups also maintain lists of sites important to their histories. These lists often contain only a portion of eligible sites. In the South alone, about 11% of the housing stock was built more than 50 years ago and could be considered historically significant. Even if a home is not officially recognized for its



historic significance, the recommendations in this booklet can still be helpful.

**Historic homes were designed and built for their environment.** In flood prone areas, they were frequently raised off the ground on piers or posts to avoid damage from high water. When possible, they were oriented facing the water to allow for air movement under the house that assists in cooling during the warmer months. Shutters were placed on windows and doors to offer shade during the hottest part of the day and protection during storms. Design elements such as these often served multiple purposes that over time may have been lost or forgotten.

Historically, people often built their homes on the highest ground because this provided the best protection from flooding. As cities and towns grow and spread out, what once was considered

Aerial image of Hurricane Katrina before it made landfall along the Gulf Coast. Image Credit: National Oceanic and Atmospheric Administration.

undesirable land is now the only affordable option available. Some of the hardest-hit areas after any disaster are often poorer, lower-lying communities that lack the natural protection found in earlier-settled areas.

Historic wood frame buildings were often built with old growth trees that were stronger and more durable than modern lumber. In Louisiana, cypress was used because of its durability in this climate. The materials and building designs utilized were able to withstand damage from a natural disaster such as flooding, better than more modern materials and designs. Numerous historic buildings in south Louisiana have proven resilient, surviving Hurricanes Betsy and Camille.

## Historic Wood Frame Construction Characteristics

- Raised Off Ground
- Brick Piers
- High Ceilings
- Wood Siding
- Double Hung Windows
- Plaster and Lath or Wood Plank Walls
- Wood Floors
- Wood Trim

After Hurricane Ike, the few historic buildings left standing on the Bolivar Peninsula in Galveston County, Texas, were able to be repaired and reoccupied. Past events have shown that historic materials can usually be salvaged after a disaster, while more modern materials are lost. Historic buildings, having withstood the tests of time and natural disasters, offer lessons in

how to build smart and protect ourselves from natural threats.

The retrofits suggested in this booklet will offer greater protection, but they are not a guarantee that a home will suffer no damage. Future storms may be more powerful than expected or planned for. A storm shutter system designed to withstand 120 mile per hour winds may fail in a hurricane or tornado with 140 mile per hour winds. Sometimes storms happen so fast that a homeowner is unable to get protections in place in time. On other occasions safety measures that are beyond the control of the homeowner may fail, as when a levee fails. While no disaster prevention plan or material is foolproof, properly hardening a home will better prepare it to withstand disasters, reduce damage, lower the cost of recovery, and allow the homeowner to return sooner.

**Careful consideration should be given to the effects of retrofits on historic homes.** Many retrofits can be completed without negatively



To be listed on the National Register of Historic Places, a building typically must be 50 years old or older and:

- A. associated with events that have made a significant contribution to the broad patterns of our history; or
- B. that are associated with the lives of persons significant in our past; or
- C. that embody the distinctive characteristics of a type, period, or method of construction, or that represent the work of a master, or that possess high artistic values, or that represent a significant and distinguishable entity whose components may lack individual distinction [historic districts]; or
- D. that have yielded, or may be likely to yield, information important in prehistory or history.

or significantly affecting historic character. However, there may be instances where the retrofit that best protects the building negatively affects its historic character or features. In those instances, the homeowner and their designer or contractor will have to discuss the best course of action. Owners of buildings with an official historic designation should consult local or state preservation offices to determine if the retrofits are appropriate. Owners of buildings listed on the National Register of Historic Places should contact the Louisiana Division of Historic Preservation for advice on specific treatments. Additional guidance can be found in the Secretary of the Interior's Standards for the Treatment of Historic Properties, which offers general guidelines and best practices for working on historic homes.

**All local, state, and federal building codes and regulations should be followed when undertaking construction projects.** Often allowances are made for historic buildings which might not otherwise meet current codes. However, homeowners should be aware that if substantial repairs or improvements are planned then the whole house may need to be brought up to code. Repairs or improvements are usually considered substantial if the cost of the work is greater than 50% of the value of the home. Some retrofits require a licensed engineer to ensure

they do not compromise the structural integrity of a building. These retrofits are identified in this booklet.

There are many factors that may affect a homeowner's decision when determining which retrofits to consider, such as aesthetics, cost, future risks, accessibility concerns, and code requirements. A simple cost-benefit analysis can help determine whether the retrofits being considered are appropriate. Before beginning a project a homeowner and the professionals they are working with should inspect the house, paying particular attention to the height of the lowest floor, mechanical and electrical equipment, and any openings in the exterior walls or floors. The condition of roof covering and the types of framing connections present should also be determined. These areas are most likely to be significantly improved with retrofits.

**Human safety always comes first.** When selecting retrofits, homeowners should consider maintenance and installation requirements. It may be impractical for an elderly or disabled homeowner to install heavy removable shutters in advance of an approaching storm. Retrofitting a home to withstand disasters does not negate basic safety considerations. Homeowners should always follow evacuation orders during a disaster.

# Disasters We Face

The Louisiana Governor's Office of Homeland Security and Emergency Preparedness and the LSU Ag Center have identified eleven hazards known in the state:

1. Flooding
2. Hailstorm
3. Hurricane
4. Tornado
5. Ice Storm
6. Storm Surge
7. Subsidence
8. Wildfire
9. Dam Failure
10. Levee Failure
11. Hazardous Materials Incident

There are numerous disaster hazards that could impact the residents of Louisiana. While not everyone is threatened by every hazard, everyone is likely at risk for more than one. Fortunately, precautions taken for one type of hazard often provide protection against other hazards.

For hazards involving **high winds**, to remove trees that are greater in height than in distance from the house, remove potential wind-borne missiles, secure siding or exterior sheathing, secure roofs, and brace gable end roof framing.

**Tornadoes** bring extremely high winds and the threat of hail. Roofs in poor condition should be retrofitted to withstand potential wind and water damage. Window films that protect glass from shattering during a storm add another layer of protection. This is discussed in greater detail in the section on windows and doors.

For those in area of the state prone to **ice storms**, be sure the roof is in good repair to lessen

the chance of leaks, make sure gutters and downspouts are cleaned out and functioning properly, and trim back any overhanging limbs that could fall on the roof due to the additional weight of the ice.

For **wildfires**, make sure all electrical systems meet building code, remove branches that overhang the roof, remove trees that are greater in height than in distance from the house, use fire resistant plants around the house, and remove all debris that could be fuel for a fire.

Often, historic homes benefit from having mature trees that provide shade and reduce energy costs. The trees and landscape may themselves be historic features of the site worthy of preservation. If this is the case, actions taken to reduce disaster risks must be balanced with the need to preserve historic character. These decisions inevitably require compromise and must be made on a case-by-case basis.

This home in the Holy Cross Neighborhood of New Orleans suffered massive damage when a pecan tree fell through the house almost cutting it in half and a levee break led to flooding. Image Credit: NPS|Sarah Marie Jackson.







**Dam failures, levee failures, hurricanes, and flooding all involve water and so, will require similar precautions detailed later in this booklet.**

Elevating or wet floodproofing a building above the Design Flood Elevation (DFE) or Base Flood Elevation (BFE) is recommended to decrease damage from these hazards. Installing a backflow valve in the building's sewer connection will prevent waste from coming into the home during a flood.

Making sure that a home can structurally withstand flooding and raising utilities above the DFE or BFE will help decrease damage.

This plantation home outside of Natchitoches, LA, suffered damage during a tornado in 2009. The attached kitchen (left) was pushed off its foundation and the metal roof was torn off the house. The underlying material, wooden shakes, did not protect from water infiltration during the storm. Image Credit: NPS|Sarah Marie Jackson.

Strengthening the foundation by bringing it up to or greater than code-required levels helps prepare for storm surges along the coast. Making sure all the components of the building are tied together and anchored properly to the foundation reduces risk from the forces of storm surges, other flooding water, and wind.

### What to Consider When Selecting Retrofits

- What type of disaster is likely to occur?
- What is the level of threat from these disasters?
- What is the level of damage from these threats?
- What impact will possible retrofits have on the historic character or features?
- Are there alternative options that protect the home from damage, but retain the historic characters or features?

# Building as a System

Buildings have many parts that work together as a system to create a safe and secure shelter. When one of these parts fails or is compromised, the home suffers catastrophic damage. For example, hurricane straps fitted to the roof will do little to prevent damage if the building is not also tied to its foundation.

**Electrical or heating and cooling systems may need to be updated to meet today's needs and safety requirements.** With modern cooling and heating systems, today's electrical needs are much greater than in the past. Consult a professional to ensure the home is safe and meets code. When performing routine upgrades to air conditioning, electrical, or other systems, it is always best to look at changes or additions to make them more disaster resistant. When it is necessary to update the wiring in a house, use the opportunity to look into raising outlets and wiring above flood levels. Electrical systems stand a better chance of withstanding flood damage if wires are run from the attic down instead of from the floor below. This approach is also applicable to air conditioning units that are located close to the ground. By elevating and securing these units above the base flood level, there is a better chance of retention after a storm.

**It is unlikely that any one retrofit will be enough to protect the home.** At a minimum, the foundation, roof, and windows should structurally meet today's construction standards and need to be protected with reinforcement against potential hazards. These critical parts need to be as strong as possible and tied to each other to decrease the chances of catastrophic damage. An unsound roof that is hit by a storm with strong winds and rain will lead to roof damage and water intrusion that can greatly increase the cost of damage. Damage to the roof will allow in water, causing further damage to the building's interior features and personal possessions.

**Recommended:** Reinforcing structural members to meet building code. Making sure components are tied together to work as a system. Raising utilities above BFE, anchoring utility components, and bringing all utilities up to code.



Top: Re-wiring masonry buildings after Hurricane Katrina. Bottom: Modern reinforcements between foundation and walls.

Image Credit: NPS|Sean Clifford and Sarah Marie Jackson

# Wall Section

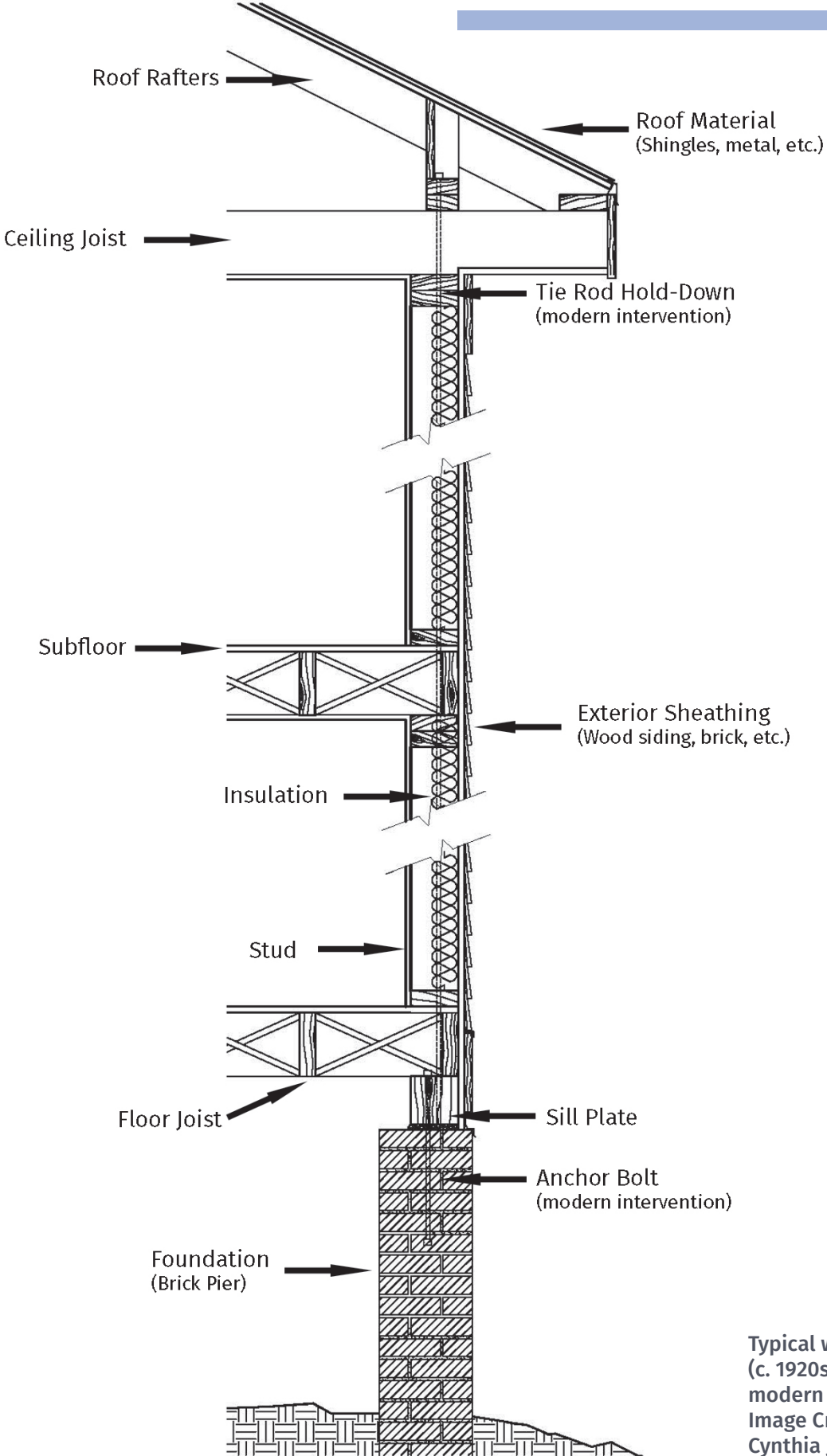

Typical wall construction (c. 1920s) with modern anchoring. Image Credit: LDHP | Cynthia J. Steward

# Structural Details

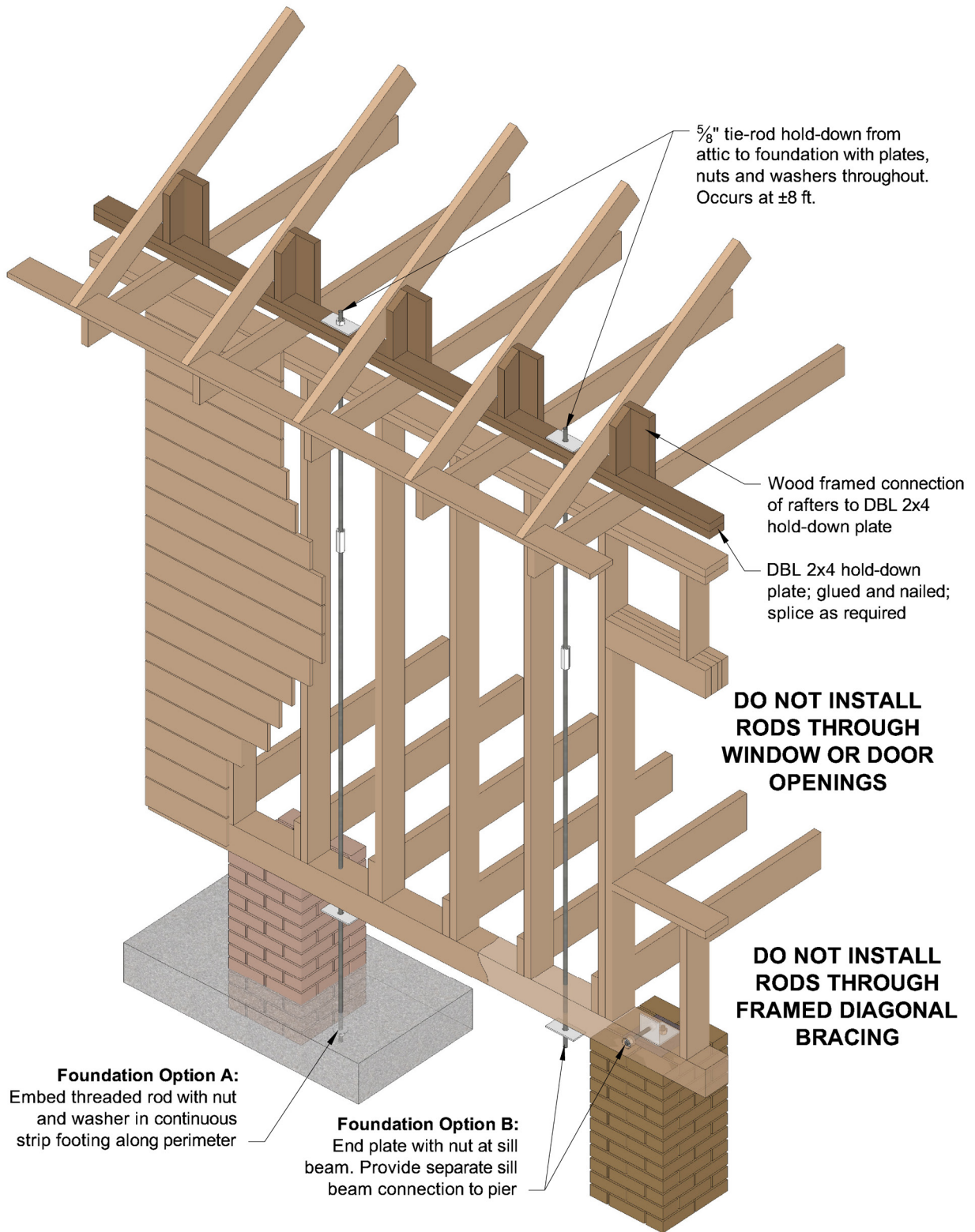

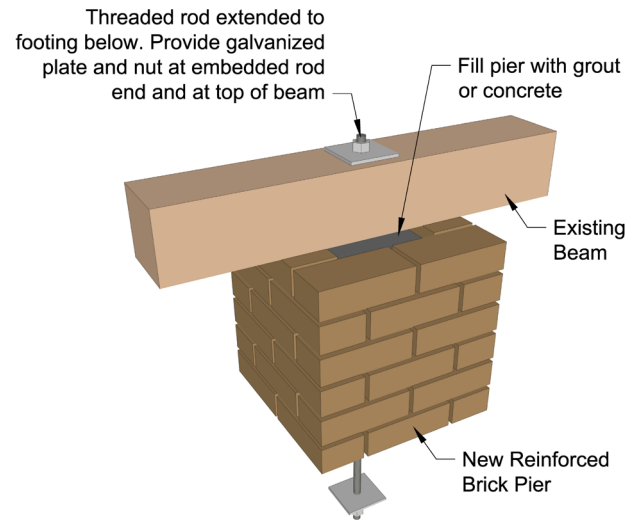
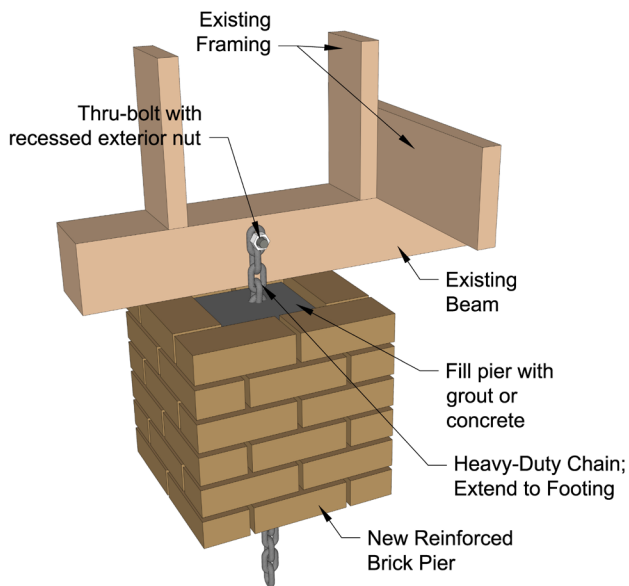
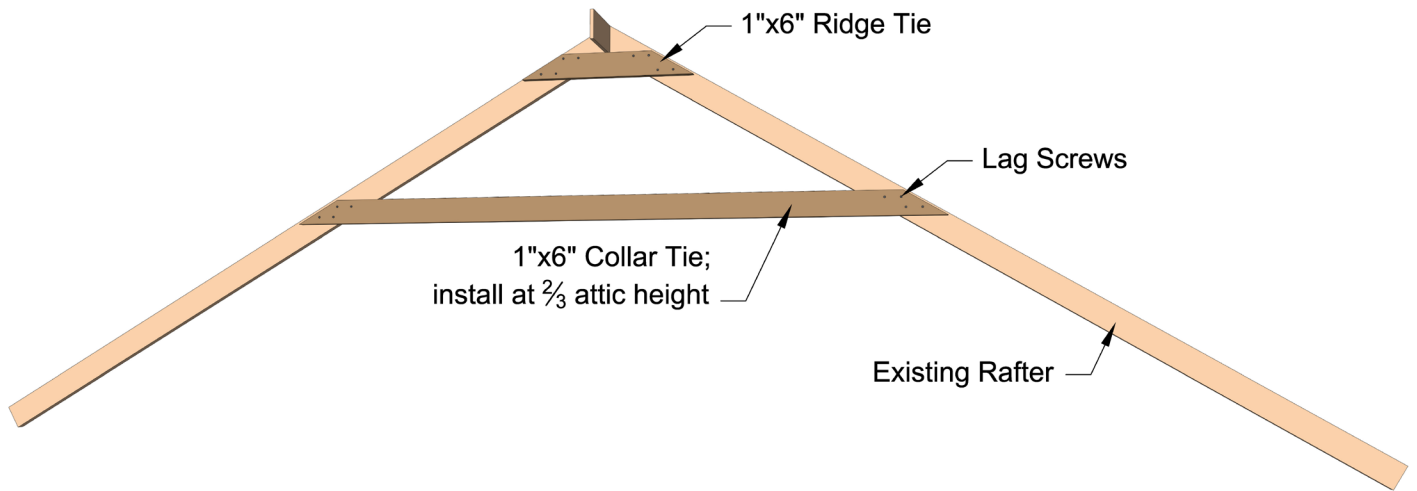

Note: Engineered design is required for houses where the basic wind speed exceeds 110mph (100 mph in hurricane wind prone regions).

Facing Page: Framing hold-down graphic showing different options for tying a building together.  
 Top: Collar tie installation to strengthen roofs.  
 Middle: Two methods of anchoring framing to piers.  
 Bottom: Method of tying together framing elements with a thru-bolt.  
 Image Credits: Sparks Engineering, Inc. | Patrick Sparks.

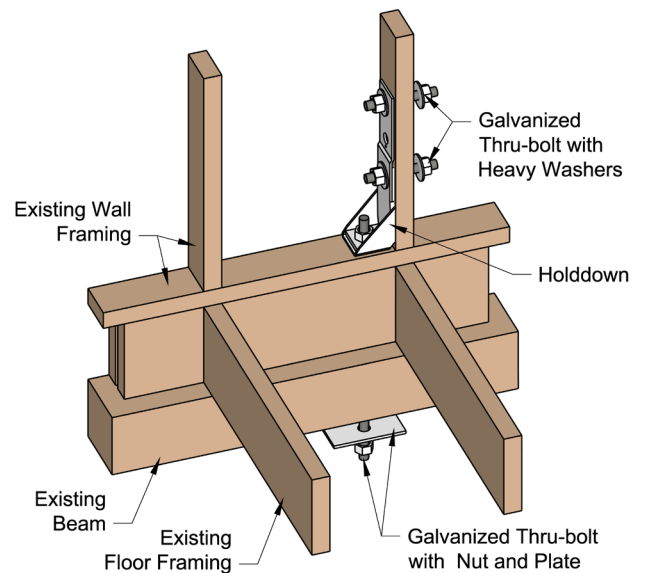

# Appropriate Materials

The choice of materials for repairs and retrofits has a major influence on the strength, appearance, and durability of a house. A few extra dollars spent on quality materials pays off in the long run.

**Hardware**, such as nails, screws, bolts, and tie rods should be either hot-dip galvanized or made of stainless steel. Introduction of untreated steel elements should be avoided as these are highly prone to rust and more rapid deterioration. Ordinary zinc electroplating, a common coating on hardware, is different from hot-dip galvanizing and is not durable enough for historic homes in Louisiana, especially those located on the coast.

Likewise, anchors embedded in masonry or existing concrete should be hot-dip galvanized or stainless steel. On the coast, a best practice is to use stainless steel rebar or stainless wire mesh for reinforcement in concrete footings and slabs. Such reinforcement is expensive, but will never corrode. Costs can be offset somewhat by placing it closer to the surface than normal and using the bare minimum reinforcement.

For off-the-shelf wood fasteners, buy hardware that uses the manufacturers' highest level of corrosion protection. For custom steel fabrications, hot-dip galvanizing is preferable and should be done after all cutting, drilling, and welding are complete to avoid gaps in corrosion protection. Series 5000 aluminum is a good choice for corrosion resistant fabrications.

Historic lumber compared with modern lumber is:

- Stronger and more durable
- Hold nails better
- Longer lengths
- Straighter grain
- Fewer knots

**Recommended:** Using hardware that is hot-dip galvanized or stainless steel to avoid rust or rapid deterioration. Replacing historic materials with in-kind contemporary materials when necessary (i.e. wood siding should be replaced with wood siding)

**Not Recommended:** Using untreated steel elements or inappropriate replacement material.

**Wood** should always be either preservative-treated southern pine or the heartwood of a naturally durable species. Non-durable wood species such as white pine, poplar, fir, or untreated southern pine should only be used in locations where they are protected from moisture and humidity and should not be placed in contact with the ground.

According to Secretary of Interior Standard's priority should be given to retaining historic materials. If materials are damaged or deteriorated it is better to repair than to replace. When replacement is the only option it should be done by using in-kind materials that have the same characteristics and material properties. By using in-kind materials for replacement over time the materials will age and act similarly to the environment.



This historic cypress rafter has a new cypress piece sistered in to replace damaged material. The darker wood is the historic material that was retained. Image Credit: NPS|Sarah Marie Jackson.

# Hazardous Materials

**Recommended:** Using contractors who are lead-Safe Certified Renovators when work disturbs lead paint. Following all available guidelines when dealing with hazardous materials.

**Not Recommended:** Disturbing hazardous materials without the proper protection.

There are several materials that were used in homes historically that are now known to be hazardous.

**Lead-based paint** is poisonous when ingested or when lead dust is inhaled. The production of lead paint was discontinued in the 1970s, but prior to that was widely used. If the paint is in good shape, lead contamination is usually not a problem. Encapsulating lead paint with a modern paint or coating will lessen the danger of exposure.

Deteriorating lead-based paint (i.e. peeling, chipping, chalking, or cracking paint) is a hazard and needs immediate attention. When renovating or conducting repair work in older homes, poisonous lead dust can be generated.

These asbestos shingles have reached the end of their life as is evident by the broken edges. A hazardous materials contractor should be consulted. Image Credit: NPS|Edward FitzGerald.

Caution and protective equipment and practices are necessary to avoid permanent health damage.

**Asbestos** can be found in older insulation, vinyl floor tiles, textured paint, patching compounds, siding tiles, and roofing tiles. When it is disturbed or the material is broken, harmful asbestos fibers are released and can cause permanent health problems for those who inhale them.

**Mold and mildew** are a common occurrence in flood damaged buildings. They may already be present in a home and can be disturbed during renovations. While mold may not cause immediate health problems, long term exposure or the exposure of vulnerable persons (e.g. the elderly or those with existing respiratory problems) can lead to serious health effects.

**Compact Fluorescent Light Bulbs (CFLs)** are also a hazard. CFLs contain a small amount of mercury that is released as a poisonous vapor when they are broken. The Environmental Protection Agency recommends removing people and pets from the room and opening a windows and doors to air out the room before cleaning up broken CFLs.



# Building Elevation

When elevating a building, the recommended first floor elevation is usually determined by **Base Flood Elevation (BFE)** or a **Design Flood Elevation (DFE)** for the area. BFE is the height which experts have determined has a 1% chance of being reached or exceeded in any given year. This is based on research by the Federal Emergency Management Agency (FEMA) that considers past flood elevations, the magnitude of these floods, the flood level of local bodies of water, and other factors. FEMA's recommendation is for the lowest horizontal structural member to exceed the BFE by a minimum of one foot. BFE is used by the National Flood Insurance Program and can be obtained from Flood Insurance Rate Maps.

Building codes sometimes use the term DFE, which can be equal to or exceed minimum BFE requirements. Check with local planning officials to see whether BFE or DFE is used in your area. The Louisiana State University Ag Center has both online flood and wind maps which allow individuals to enter their address and find flood zones, wind speed, and ground elevations. Information can be different from neighbors' and sometimes locations on the maps can be off. So, it is important to ensure that the point indicated on the map is correct. Engineering design is always required if the house is in a "V" (velocity) or coastal "A" (moderate waves) zone.

Foundations are designed to carry the load of a building and anchor it to the ground. During a disaster the foundation is affected by multiple forces. Floodwaters and debris in the floodwater place pressure on foundation walls, piers, piles, or posts. Water can also saturate soil creating additional forces on the foundation. Raising a building to elevate the first floor above BFE or DFE can also allow for strengthening of the foundation to better withstand these forces. When a foundation collapses or a building is washed off of its foundation, greater recovery

**Recommended:** Work with LDHP to address necessary elevating requirements. Designing foundations to withstand the loads and additional forces of flood waters. Anchoring buildings to their foundation.

**Not Recommended:** Not anchoring properly, or not strengthening the foundation.

efforts, additional expenses, or even catastrophic failure result.

**Raising the elevation of a building lessens damage from flooding.** The Louisiana Division of Historic Preservation and FEMA have information available on elevating homes. The key to getting the best results is to work with a professional architect or design consultant with experience working with historic buildings and a professional engineer to make sure the foundation is designed to withstand flood forces. Hiring an experienced contractor who has successfully completed similar projects will also increase chances of success.

When a home is elevated, steel beams are placed under the first floor to support the building and jacks are used to raise the house. A new foundation is constructed which should meet current building codes and be able to withstand the load of the home and forces from a flooding event. Exterior material such as brick or stucco veneer may need to be removed before raising the building. Additions to the original building may need to be raised separately. Heavier, taller, or complex shaped houses may make these projects more complicated and increase costs.

Houses that are already raised off the ground (buildings with a crawl space) are easier to lift above flood levels. Buildings constructed on a concrete slab are more difficult to elevate and may need additional support or a new floor. To raise a house built on piles, it must first be moved out of the way to allow access for machinery needed to drive, jet, or auger the new piles. New foundations should be designed





## Wind Speed and Elevation Map

This interactive map will give you basic wind speed and ground elevation at points in the state of Louisiana. The map, based on the 2003 building codes, was in effect in Louisiana from Jan 2006 to Dec 2012. Effective Jan 2013 the map from the 2012 building codes is the appropriate reference. This map can not be used in place of an elevation certificate or as the official wind speed for meeting building codes. This site is for information only; visit your local permit office to obtain your official wind speed. SEE FURTHER DISCLAIMER LINK BELOW BEFORE USE.  
This site was developed with support from The Road Home Program under BOA 27DB00011.

Latitude:  Click the map

Longitude:  Click the map

IRC Wind Speed:  Click the map

Elevation:  Click the map

IRC BWS:  2013  
Layers:  2006 - 2012

Hide Legend:  On/Off

IRC Basic Wind Speed Legend

90 mph
> 90 mph - 100 mph
> 100 mph - 110 mph
> 110 mph - 120 mph
> 120 mph - 130 mph
> 130 mph - 140 mph
> 140 mph

**Find an Address**

(Street, City, State, Zip Code)

Enter Address to Search

0 30 60mi

by a professional structural engineer who will ensure that loads are accurately calculated and foundation wall and sill plate connections are designed correctly. The new foundation must meet current codes and structural systems must be tied together, from the roof to the foundation, to reduce risks from future events.

The Wind Speed and Elevation Map from Louisiana State University allows users to determine the BFE, flood zone, and wind speed that must be considered when designing resilient retrofits to meet building code. Image Credit: LSU Ag Center.



Top Left: House in New Orleans that was elevated after Hurricane Katrina.

Bottom Left: Wood frame home with cribbing visible in the process of being raised after Hurricane Katrina.

Top Right: The iron beams and wire cables are in place in preparation for raising Yucca House at Melrose Plantation, Melrose, LA. The floor was already missing when the project began.

Bottom Right: House in New Orleans, LA that was elevated after Hurricane Katrina.

Image Credits: LDHP & NPS

**Recommended:** Using wet floodproofing when elevating a historic home is not an option.

**Not Recommended:** Dry floodproofing is not appropriate for historic homes. Permanent levees and flood walls are rarely appropriate for a historic home and are cost prohibitive.

Floodproofing includes any combination of structural and non-structural additions, changes, or adjustments to structures that reduce or eliminate flood damage to real estate or improved real property, water and sanitary facilities, structures and their contents.

The intent of **dry floodproofing** is to make a building watertight to one foot above BFE or the DFE by applying a waterproof coating or impermeable sheeting to the exterior. All openings, such as windows and doors, must be closed off during a flood with temporary or permanent shields.

Dry floodproofing is not recommended for historic buildings as the coatings used are difficult to remove without damaging the underlying materials and would change the appearance of the building where they are applied. Applying a waterproof coating or impermeable sheeting to the existing foundation and exterior walls does not mean they will be able to withstand the physical forces of a flood. The building must still be anchored to its foundation in order to resist the forces of water and movement. This retrofit only works for buildings that are built on grade (i.e., built level with the ground) and have an impervious exterior wall material like brick or concrete. This retrofit also works best only for short flooding events since coatings may deteriorate during extended flooding.

**Wet floodproofing** involves planning for the home to flood and making preparations to reduce the damage when it happens. Wet floodproofing is achieved by raising utilities, structural components, and contents above BFE. This treatment is only recommended for certain situations, such as a historic building

# Flood Proofing

An 'elevation certificate' prepared by a licensed surveyor is a required document for any house in or near a potential flood zone. This certificate states the actual elevation of the first floor of the house, in feet above mean sea level.

that cannot be elevated or otherwise protected. This treatment requires some work in advance of a storm and more intervention than many of the other options available. Wet floodproofing is typically less expensive than other floodproofing options, but can lead to more interior damage as it allows water to enter and recede. Because the building is purposely allowed to get wet, it may take longer before it can be re-inhabited after a flood.

**Permanent levees** constructed around the building are another option but can be very large and costly. Levees require an engineer and permits to determine if they are appropriate for a site. Similar to levees, **floodwalls** are expensive to build and, though they require less space, may present some of the same issues. Both levees and flood walls may create the perception that they are forcing more flood waters towards a neighbors' property. For both levees and floodwalls, it is important to consult building and zoning codes and check for utility lines before beginning construction. Local authorities must be consulted before constructing levees or floodwalls. A homeowner may be required to work with a Federal agency to design and develop a levee. Poorly designed and maintained levees or floodwalls can be more a threat than protection if they fail.

# Drainage

**Recommended:** Directing water away from the home either through grading or drains.

**Not Recommended:** Channeling water towards the house or neighboring homes.

**Part of the task of keeping water out of a historic building is to direct the water away from it.** This is done by keeping roofs, gutters, and downspouts in working condition and channeling water collected by these into appropriate subsurface drainage. Grade the soil so that water drains away from the building. Point downspouts away from the building and onto splash blocks when grading alone is not sufficient. Catch basins, trench drains, or perforated French drains may be needed in some cases. For these retrofits, it may be necessary to consult a landscape architect or a civil engineer who can visit the site to determine the best course of action.

filled with gravel to assist in keeping them free of silt and other debris that will hamper their effectiveness. Drain pipes must slope away from the house and empty into a storm drain, ditch, or field that can handle the additional water. Water should never be diverted toward another structure.

**Trench drains** with grating covers can be a good option for difficult to drain sites. These differ from French drains in that the bottom of the drainage channel is not perforated. It is possible to empty downspouts into a trench drain. A trench is dug and a drain pipe is laid in the trench to carry water away from the structure. **French drain** pipes may also be wrapped in filtering fabric or

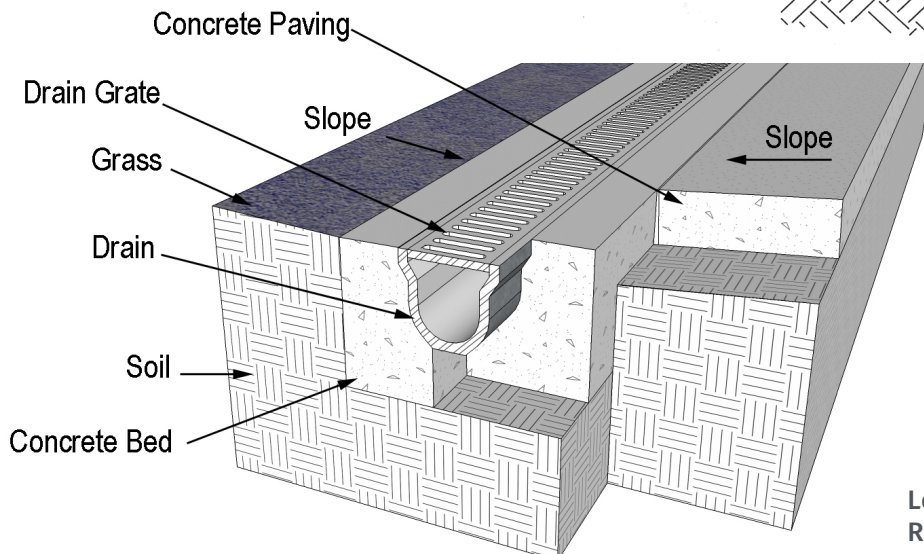
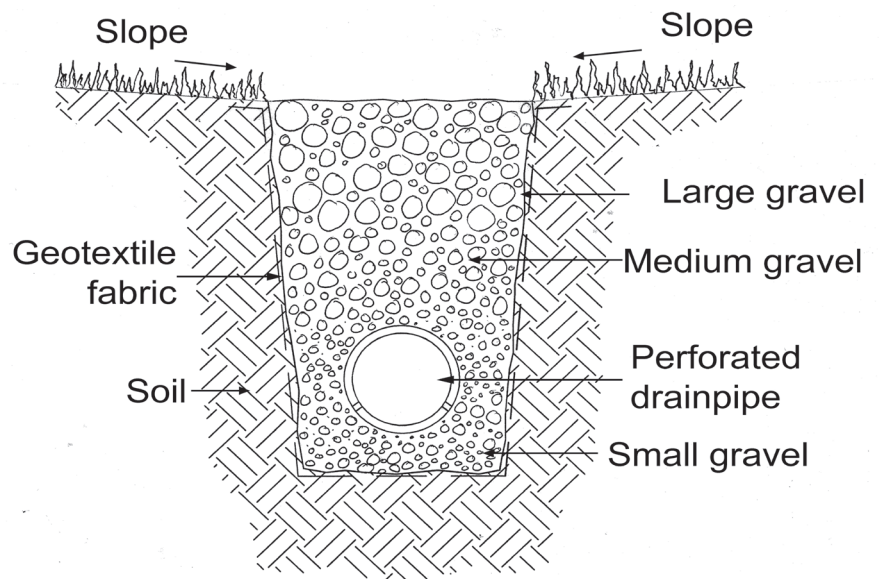

Left: Trench Drain Diagram.  
Right: French Drain Diagram.  
Image Credit: LDHP | Cynthia J. Steward

**Recommended:** Reinforcing porch elements and tying the porch roof, columns, and foundation together.

**Not Recommended:** Removing or closing in historic porches.

Porches are a common design element in the south and serve multiple functions. They provide shade and protect doors and windows from the elements. Historically, porches were used to escape the heat of an un-air conditioned house by providing both shade and air movement. **Removing or closing in a porch is not recommended for historic buildings** as this will change the historic character of the home.

During a wind or flooding event, **porches can be a weak link** that leads to damage. Porches may pull away from the building during these events, allowing wind and water to enter the building through unprotected openings or damaged areas. Porch elements that are not adequately attached can come loose and become wind-borne missiles.

**It is important to understand how the porch roof is attached to the main building.** Porch roofs are often either constructed as an extension of the main building roof or as a separate roof attached to the exterior wall. The failure of a porch and its roof can lead to water infiltration and damage to the building's interior. Examining how a porch is connected to the primary structure can help identify weaknesses.

**Reinforcing the porch will help ensure that all the elements of the building are tied together and working as a system.** Hurricane straps or other fasteners should be securely installed, connecting roof rafters to ledgers and beams. The roof structure should also be securely fastened to the columns, and columns should be fastened to the porch floor or foundation. Anchor bolts can be used to connect the porch sill to the foundation. Care should be taken to ensure that any added reinforcing is not placed in visible locations that might disrupt the historic appearance of the home. If a porch is beyond

## Porch & Porch Elements

repair or is not historically accurate, a new porch may be reconstructed using compatible materials that meet modern building code. Local design approval may be required if located in a historic district.



Top: Two-story columns on a historic home in Alexandria, LA.

Bottom: Note the galvanized metal straps tying this porch floor framing back to house sill plate.

Image Credits: NPS|Sarah Marie Jackson & Edward FitzGerald.

# Roofs & Chimneys

**The best time to upgrade a roof is when it needs replacement.** Use this opportunity to incorporate new storm-resistant materials, secure the roof decking, and strengthen the connections. All of these things offer additional protection from high winds. This is also a good time to add waterproof self-adhering membrane or “water shield” to the roof deck. Water shield membranes provides backup protection if shingles or other roofing materials are blown off by a storm. Wind-resistant shingles offer additional protection. The exterior roofing materials should always be replaced with in-kind materials unless there is a compelling reason to change them.

**A roof that is nearing the end of its service life or that is not well maintained is more susceptible to damage from high winds.** While replacing the roof may not be part of the plan, strengthening the connections between structural elements provides protection against wind uplift. Ensure that roofing and roof sheathing are well attached to the framing. Strengthen or replace roof vents. Make all necessary repairs to ensure the roof can resist high winds. Apply a construction adhesive along the roof deck and rafters connecting the pieces can strengthen the connections and does little to alter historic character.

For **gabled roofs**, gable ends are often the tallest walls on a house and are frequently improperly braced or connected to the building’s structure. These walls and roof edges are particularly susceptible to high winds. Adding gable end bracing prevents failure of the gable and securing the roof structure to the end wall prevents uplift. These retrofits can be easily and discretely accomplished from the attic space and should be a high priority.

**Chimneys** should be braced and securely attached to the building to reduce the risk of failure during a storm. High winds can topple a chimney, causing it to collapse onto the roof. Flooding can wash-out a chimney foundation.

**Recommended:** Adding a waterproof membrane and strengthening roof connections when replacing a roof. Adding collar ties and gable end bracing (see page 12). Bracing and securing chimneys. Maintaining roofs to lessen damage during a disaster.

**Not Recommended:** Not maintaining or repairing roofs as needed. Not strengthening materials and connections when possible. Allowing leaves and debris to build up on a roof or in gutters.

If a chimney falls, it could not only damage the building, but also surrounding buildings or landscape features. Chimneys must be braced if they are more than 2 1/2 times taller than they are wide. Metal strap bracing can be added to attach the chimney to structural elements such as ceiling or floor joists. If the mortar that holds the masonry together is weak or missing, it should be repointed to ensure stability.

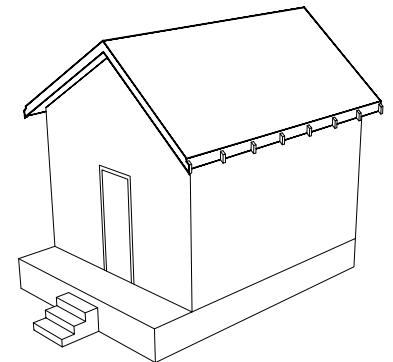

**Gable**

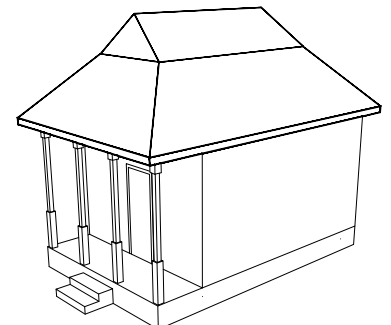

**Double Pitch Hip**

# Roof Materials

Roof Materials (clockwise from top left): standing seam metal, terracotta tile, slate, corrugated metal, asbestos tile. Image Credits: NPS|Sarah Marie Jackson & Patrick Sparks



# Roof Styles

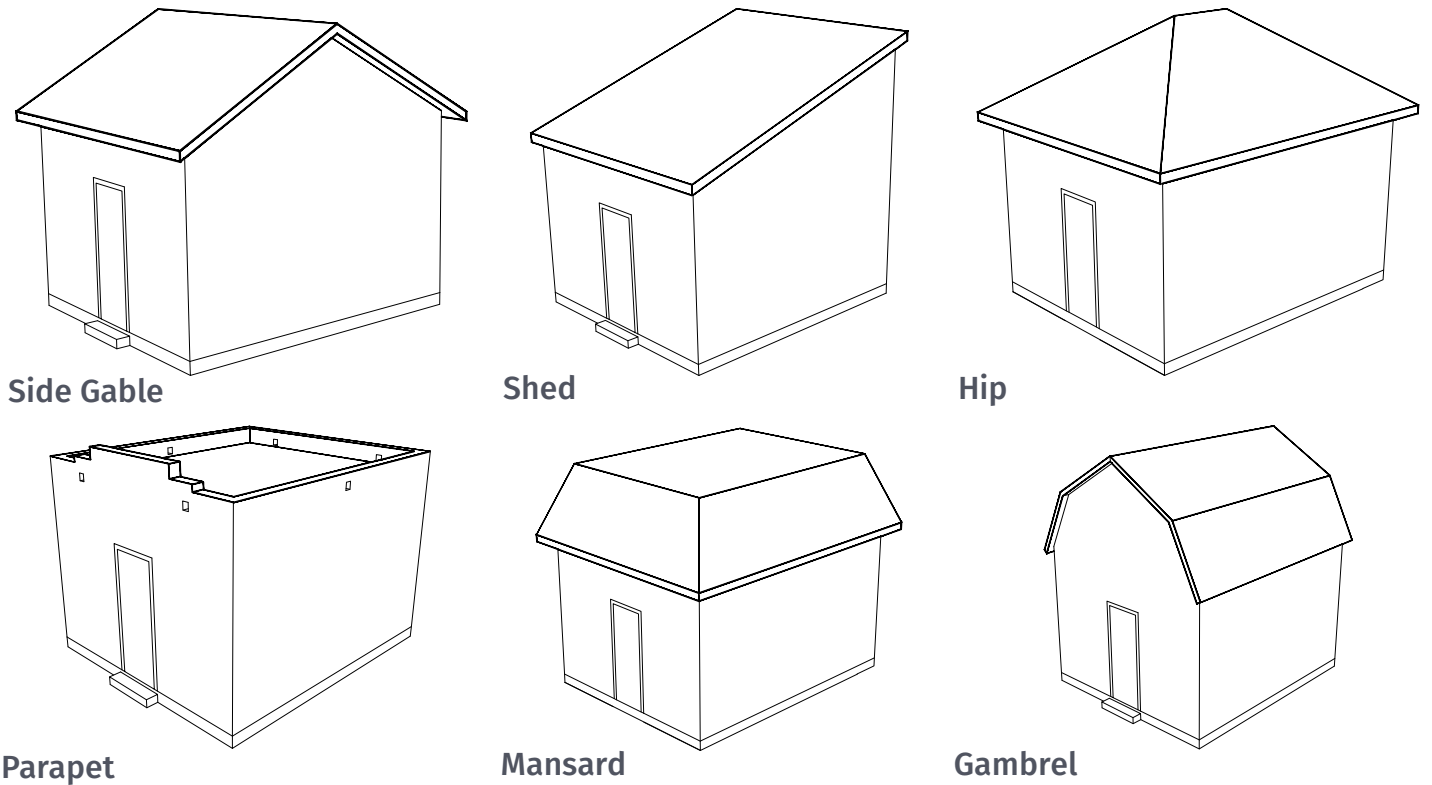

Roof styles drafted by Cynthia J. Steward, LDHP

# Windows & Doors

**Windows and doors play an important role in protecting a home during a storm.** They stop rain and wind from entering, keeping the interior dry and preventing the forces of wind uplift from lifting off the roof or otherwise damaging the structure. When damage is sustained inside a home, repairs are more expensive compared to just exterior damage. Personal possessions can be damaged or destroyed. All openings in the exterior of a building should be secured to withstand high winds and wind-borne debris. Prior to a storm, homeowners should remove or secure items in the yard that may become wind-borne missiles.

Broken glass in windows or doors allows rain to enter, damaging the structure, interior finishes, and contents. Latching mechanisms should be added to all windows and doors to lessen the chance of them being forced open by high winds. Windows can be protected with added storm windows, storm shutters, temporary storm panels, window films, or storm screens. Interior or exterior storm windows are available and can also help lower energy costs by reducing air infiltration in historic homes.

**Shutters** are a common and often distinctive feature of many native Louisiana building styles and are common on both windows and doors. Other styles imported from different climates, like Arts and Crafts bungalows or Mid-Century ranch houses, either had no shutters or had false ones permanently affixed to the side of the building. Shutters were historically used for ventilation, privacy, and to shade building interiors from the sun. They also protected glass windows and doors from breaking in a storm. Reproduction shutters can be manufactured to match historic materials and details. Modern roll-up or folding shutters attached to

**Recommended:** Strengthening door and window hardware where appropriate (if hardware is historic explore alternatives). Adding temporary or permanent protection to all openings.

**Not Recommended:** Roll down shutters, see-through corrugated plastic shutters, accordion shutters, or modern shutters do not match the aesthetics of historic homes.

the exterior change the appearance of a historic building and are not recommended.

**Temporary storm panels** are preferable alternatives to modern retrofit shutters. Temporary storm panels can be made from plywood or corrugated metal and should be produced ahead of time to be on hand when a storm is imminent. Fabric storm panels or screens, impact resistant film added to glass, or woven metal screens may be less noticeable than modern shutters and detract less from the historic character of the building while still offering some protection. When installing permanent barriers like shutters or screens, it is important that they be appropriate to the style of the building.

**Double-hung Window Components.** Image Credit: New Orleans Historic District Landmarks Commission

## DOUBLE-HUNG WINDOW COMPONENTS

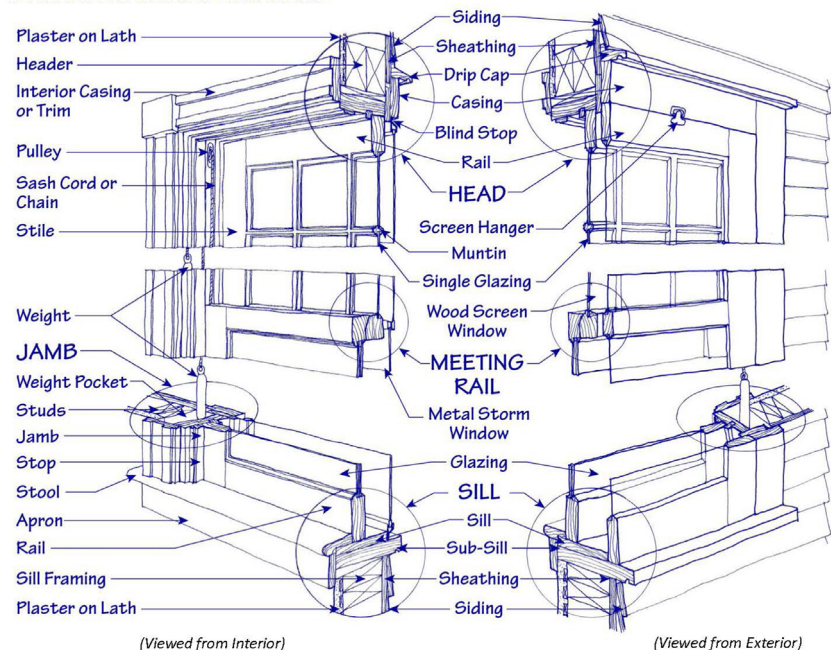





## Recommended

Window Treatments (left to right): operable shutters and exterior storm windows.  
Image Credits: LDHP and NPS|Edward FitzGerald



## Not Recommended

Not recommended (clockwise from top left): barn style shutters do not match the style of this historic house, corrugated plastic storm windows are an obtrusive addition, roll-down aluminum shutters change the appearance of this historic bungalow.  
Image Credits: NPS|Edward FitzGerald



<b>Retrofit</b>	<b>Description</b>	<b>Advantages</b>	<b>Notes</b>	<b>Priority</b>	<b>Installation</b>
<b>Building Elevation</b> (pg. 13)	Raise above BFE or DFE	Easier on houses with crawl spaces	More complex for houses with additions or on grade	High	Professional
<b>Dry Flood Proofing</b> (pg. 16)	Walls are coated with water proof material and all openings must be closed off during a flood	Works best on masonry buildings whose foundations are built on grade	Not recommended for historic buildings and materials	Low	Professional
<b>Wet Flood Proofing</b> (pg. 16)	Flooding is planned for by moving utilities and contents above the BFE or DFE	Alternative for homes that cannot be elevated	Could result in more damage	Medium	DIY or Professional
<b>Levees</b> (pg. 16)	Large embankment. Rule of thumb that for every 1 ft in height the levee must be 7 ft wide	Prevents floodwaters from reaching the house	Can be very large and may provide the perception that you are diverting water towards your neighbors	Low	Professional/ Government
<b>Floodwalls</b> (pg. 16)	Wall constructed around home or property to protect against floodwaters	Prevents floodwaters from reaching the house	Can be very large and may provide the perception that you are diverting water towards neighbors	Low	Professional
<b>Site Drainage</b> (pg. 17)	When the land slopes towards a building it can guide water towards the building	Grade the landscape away from buildings	Can disrupt the landscape that may have historic plantings	High	DIY or Professional
<b>French Drain</b> (pg. 17)	Typically a trench that has a slotted pipe to divert water away from buildings	The drain is buried in the ground and will not be visible	Will have to disturb site to dig drain	Medium	DIY or Professional
<b>Porch</b> (pg. 18)	Reinforce structural elements and tie together from foundation to roof	Prevents porch and its elements from being washed or blown away	If the roof is an extension of the main roof and the porch pulls away from the house this can lead to water infiltration on the interior	High	Professional
<b>Chimneys</b> (pg. 19)	Repair and anchor to house	The mass of a chimney can serve as an anchor for a building	May require some repointing or reconstruction to strengthen or stabilize	Medium	Professional

<b>Retrofit</b>	<b>Description</b>	<b>Advantages</b>	<b>Notes</b>	<b>Priority</b>	<b>Installation</b>
<b>Roofs</b> (pg. 19)	Well maintained roofs should sustain less damage during high winds. Connections should be strengthened to tie the structure together	If your roof has reached the end of its life and needs replacement this is the time to add a water proof membrane and strengthen connections	When replacing a roof this is the best time to upgrade. Your options may be limited if your are not replacing your roof which should not be done for a roof in good condition	High	Professional
<b>Windows and Doors</b> (pg. 21)	All openings should be secured	WAdditional or stronger hardware may be needed	May take longer to determine appropriate hardware for historic windows and doors	High	DIY or Professional
<b>Window Films</b> (pg. 21)	Can be added to existing windows to hold glass fragments together during high impacts	May also provide a savings to homeowners long term by reducing energy costs	May not provide adequate protection from wind borne debris	Medium	Professional
<b>Temporary Shutters</b> (pg. 21)	Provide protection for glass against wind-borne debris	Can be prepared ahead of time for quicker installation when a storm approaches	Need to be installed when a storm is imminent. Homeowners should be physically able to do this themselves or have a plan for an event	Medium	DIY
<b>Permanent Shutters</b> (pg. 21)	Provide protection for glass against wind-borne debris	Can be put in place before a storm and may be easier for homeowners who are physically challenged to execute	Aluminum roll down shutters stand out on historic facades. Permanently attached shutters may block egress	Low	Professional
<b>Storm Windows</b> (pg. 21)	Provide protection for glass against wind-borne debris	Can be installed on the interior or exterior	Exterior storm windows are often not recommended for historic homes; Interior storm windows will protect against water infiltration but will not protect the windows	High	DIY or Professional

# Conclusion

No matter the budget, there are practical measures that can be taken to harden historic homes against disasters. Some of these measures, such as reinforcing structural systems from the roof to the foundation, should be considered by all homeowners. Utilities and mechanical systems should be raised in flood-prone areas. Foundation drainage and the ground slope should lead water away from the structure.

Some retrofits are simple enough that homeowners could easily make them themselves, while others will require professionals to complete. Some work may need to be done over time depending on the financial and material resources available. Ultimately, homeowners must decide which retrofits will work best for their situation and what will offer the greatest protection for their homes and families.

It is important to remember that all the retrofits discussed in this booklet are intended to work together as a system. Rather than tackle everything at one time, pick one thing and do it right. There is little point in upgrading roof shingles to a wind resistant material if the roof framing is incorrectly attached to the walls below. For any measures that alter or change the structural system of the home, it is best to work with a professional engineer to ensure retrofits are structurally sound.

Historic homes were designed and built well so that all of the different parts of the building worked together to resist the elements and provide protection to inhabitants. There is no retrofit, upgrade, or even new construction method that will prevent all damage during a natural disaster. However, by preparing a historic home to face the next storm, flood, or fire, we can minimize damage and ensure that the building will remain for future generations to enjoy.

**Left: Historic home near Donaldsonville, LA.**

**Middle: Log cabin in Caroline Dorman Nature Preserve in Saline, LA.**

**Right: Shotgun house near Donaldsonville, LA.**

**Image Credit: NPS| Sarah Marie Jackson**



# Glossary

---

**BFE** Base Flood Elevation, the computed elevation to which floodwater is anticipated to rise during the base flood or having a 1% chance of being equaled or exceeded often know as “100 year flood”

**Design tolerance** an allowable amount of variation within the specified design of a building part or system.

**DFE** Design Flood Elevation, the BFE from the flood insurance rate map (FIRM) or an elevation designated on a flood hazard map adopted by the community in which the project resides

**FEMA** Federal Emergency Management Agency; the Federal agency tasked with coordinating the response to a disaster that has occurred in the United States

**Floodproofing, wet** making utilities, structural components, and contents flood- and water-resistant during periods of flooding within the structure

**Floodproofing, dry** making a structure watertight, often by applying a waterproof coating and closing off all openings below BFE. Strengthening the foundation, floors and walls is often necessary to withstand the additional forces during a flood

**Freeboard** the extra height of the structure above the Base Flood Elevation if Design Flood Elevation is greater than BFE;  $\text{Freeboard} = \text{DFE} - \text{BFE}$

**French drain** a drain pipe that is perforated to receive water from the surrounding soil. Usually buried just below the ground surface, or deeper to protect a basement from water entry. Can be covered with soil or gravel to also receive surface water. Never connect a downspout to a French drain.

**Gable end** the triangular section of a wall that meets the edges of a gable roof (see gable roof drawing page 19)

**Hardening** strengthening a building to better withstand a disaster and lessen the damage from such an event

**Integrity** the authenticity of physical characteristics from which properties obtain their significance

**LDHP or DHP** Louisiana Division of Historic Preservation; serves as the staff of the appointed State Historic Preservation Officer for federal programs that pertain to historic buildings, structures, and places as such appointment is required by the National Historic Preservation Act, 54 USC, as amended. The LDHP also oversees a number of state historic preservation programs

**National Register** National Register of Historic Places; the official list of the Nation’s historic places worthy of preservation; authorized by the National Historic Preservation Act of 1966 and administered by the National Park Service

**Pier** a pillar, or similar construction, that supports a building or other superstructure

**Pile** a structural support (e.g. large timbers, steel, or concrete) driven into the earth to support a building or other superstructure

**Pointing or repointing** removing failed mortar and replacing with appropriate or in-kind new mortar

**Risk** the potential negative effect of a disaster event, determined by combining the likelihood of the event occurring with the effect of the event should it occur

**Slab-on-grade** a poured-in-place concrete slab that forms the foundation of a building or other superstructure

**Secretary of the Interior's Standards** series of best practices for maintaining, repairing, and replacing historic materials, as well as designing new additions or making alterations

**Scour** localized loss of soil or rock usually around a foundation

**SHPO** State Historic Preservation Office; comprised of the Division of Historic Preservation and the Division of Archaeology, whose staff administer federal and state mandated preservation programs as outlined by the National Park Service and the National Historic Preservation Act of 1966, as amended; **also SHPO** - State Historic Preservation Officer appointed by the Governor or his designee to administer the State Historic Preservation programs

**Storm drain** a pipe, usually underground, that carries storm water away and into a discharge area, such as a stream, bay, or municipal storm sewer system. Unlike a French drain, the pipe is not perforated

**Storm windows** windows mounted inside or outside of the main glass windows of a house to improve thermal efficiency and protect main windows against damage during inclement weather; can be made of glass, rigid plastic panels, or flexible plastic sheets

**Storm shutters** covering to protect windows from being broken by flying debris during a storm

**Storm screen** metal screens which can be installed over windows, without interfering with fenestration or exterior sight lines, to protect windows from flying debris

**Subsurface drainage** removing excess groundwater through buried pipes

**Temporary storm panels** temporary covering that can be installed when a storm is imminent to protect windows from flying debris during a storm

**Trench drain** type of surface drain channel usually covered by removable grating. The trench drain is not perforated on the bottom or open to the soil, so it is permissible to use them to carry water from a downspout

**Water shield** also known as a leak barrier, the water shield is a self-adhering rubberized membrane that is installed under the roofing material and directly on the roof deck. Takes the place of traditional felt paper underlayment

**Water tight** closing off all openings so as not to allow water to enter

**Window film** film added to existing windows to hold glass fragments together during high impacts

**Uplift (Wind Uplift)** a force generated by wind on a roof system or components of a roof system; when uplift is greater than the system was designed for, the roof could potentially lift off the building

# Additional Resources

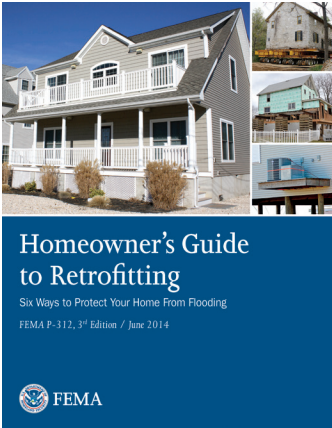

Homeowner's Guide to Retrofitting, FEMA

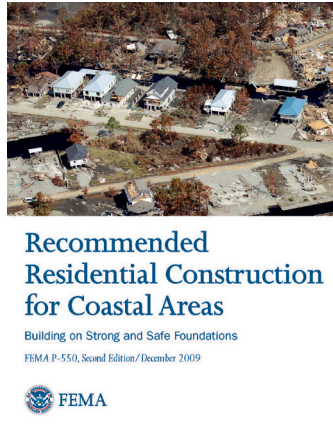

Recommended Residential Construction for Coastal Areas, FEMA



Disaster Mitigation for Historic Structures: Protection Strategies, 1000 Friends of Florida

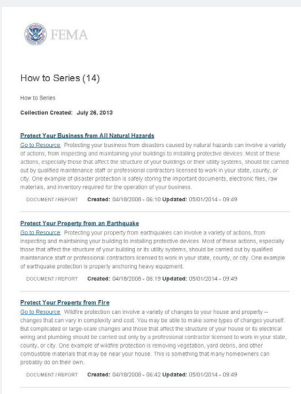

How To Series, FEMA

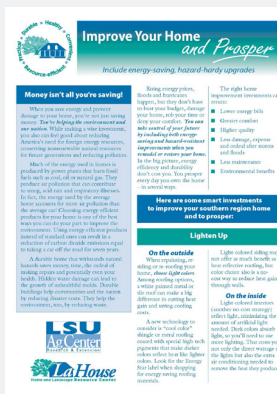

Improve Your Home and Prosper, LSU Ag Center

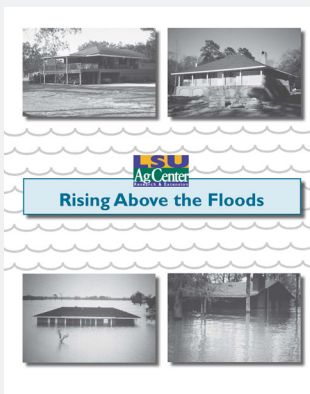

Rising Above the Floods, LSU Ag Center



Against the Wind: Protecting your Home from Hurricane and Wind Damage, FEMA

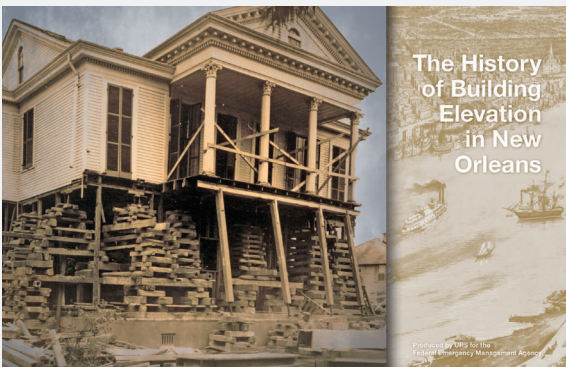

The History of Building Elevation in New Orleans, FEMA

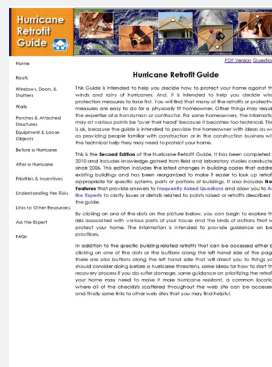

Hurricane Retrofit Guide, Florida Disaster



Add Strength and Water Resistance When Repairing Your Roof, LSU Ag Center



Preservation Briefs, Technical Preservation Services

Note: All of these resources can be found online by searching the title and author.

This booklet highlights the best practices for hardening historic homes in Louisiana, including anchoring structures, floodproofing, etc. Aimed at owners of residential properties, the booklet also offers valuable insights for local historic commission members, city government staff and professionals in related fields.

By saving an important part of our heritage, the Division of Historic Preservation energizes Louisiana's cultural economy. We help local craftsmen, artists, and lovers of history find places to live, work, and play. Although we strive to preserve the best examples of our state's architecture, we also focus upon buildings representing the forces that shaped Louisiana's history and culture. To make these things happen, we actively assist property owners to apply for National Register status and qualify for the federal and state tax incentives that often make the restoration of historic buildings possible.



Top: Cherokee Plantation in Natchitoches, La.  
Middle: Autrey House is a dogtrot log house in Lincoln Parish, La.  
Bottom: Historic home in Plaquemines Parish, La.  
Image Credits: NPS|Sarah Marie Jackson & Edward FitzGerald

For more information:

<http://www.crt.state.la.us/cultural-development/historic-preservation/>

Louisiana Division of Historic Preservation  
Office of Cultural Development, Dept. of Culture, Recreation & Tourism  
P.O. Box 44247, 1051 North Third Street, Baton Rouge, LA 70804  
Phone: (225) 342-8200

National Center for Preservation Technology and Training  
645 Univeristy Parkway, Natchitoches, LA 71457  
Phone: (318)356-7444  
Web: [ncptt.nps.gov](http://ncptt.nps.gov)

Governor's Office of Homeland Security and Emergency Preparedness  
7667 Independence Blvd., Baton Rouge, LA 70806  
Phone: 225-925-7500  
Web: [gohsep.la.gov/](http://gohsep.la.gov/)